

Register your product and get support at
www.philips.com/support

32PFL5708/F7
39PFL5708/F7
40PFL5708/F7
47PFL5708/F7
50PFL5708/F7



EN User Manual

To obtain a more detailed electronic copy of this manual, go to www.philips.com/support

ES Manual del Usuario

Para obtener una copia electrónica más detallada de este manual, visite www.philips.com/support

FR Manuel d'Utilisation

Pour obtenir une copie électronique plus détaillée de ce manuel, allez sur www.philips.com/support

EN: For further assistance, call the customer support service in your country.

- To obtain assistance, contact Philips Customer Care Center; In the U.S.A., Canada, Puerto Rico, or the U.S. Virgin Islands **1 866 309 5962** México D.F. and Área Metropolitana; **58 87 97 36** Interior de la Republica; **01 800 839 19 89**

ES: Para obtener más información, llame al servicio de soporte al cliente de su país.

- Para obtener asistencia, comuníquese con Centro de atención al cliente de Philips; En los Estados Unidos, en Canadá, Puerto Rico o en las Islas Vírgenes de los Estados Unidos; **1 866 309 5962** México D.F. y Área Metropolitana; **58 87 97 36** Interior de la Republica; **01 800 839 19 89**

FR: Pour obtenir de l'aide supplémentaire, communiquez avec le centre de service à la clientèle de votre pays.

- Pour obtenir de l'aide, communiquez avec le centre de service à la clientèle Philips au; Dans le États-Unis, au Canada, à Puerto Rico ou aux Îles Vierges américaines; **1 866 309 5962** México D.F. et Área Metropolitana; **58 87 97 36** Interior de la Republica; **01 800 839 19 89**

PHILIPS

Contents

1 Notice	5	7 Useful tips	33
2 Important	7	FAQ	33
Positioning the TV	7	Troubleshooting	34
Regulatory notices	7	8 Information	35
Environmental care	7	Glossary	35
Downloading an electronic copy	7	Maintenance	36
3 Get started	8	9 Specifications	37
Features	8	10 Warranty	38
Supplied accessories	8		
Symbols used in this User Manual	8		
Attaching the base	9		
Managing cables	9		
Installing the remote control batteries	9		
Remote control function	10		
Control panel	11		
Terminals	11		
Connecting the antenna or unencrypted cable	12		
Plugging in the AC power cord	12		
Initial setup	13		
4 Use your TV	15		
Switching on your TV and putting it in Standby mode	15		
Adjusting volume	15		
Switching channels	15		
Watching channels from an external device	16		
Access the Home menu	16		
Sleep timer	16		
Changing picture format	16		
TV screen information	17		
5 Use more of your TV	18		
Picture	18		
Sound	19		
Setup	20		
Autoprogram	21		
Language	22		
Features	22		
Child lock	23		
Caption settings	25		
Sleep timer	26		
EasyLink	26		
Location	26		
E-sticker	27		
USB	27		
PHOTO	28		
MUSIC	28		
MOVIE	28		
Upgrading the software	29		
6 Connecting devices	29		
Selecting your connection quality	29		
Connecting your devices	30		

Return your Product Registration Card or visit at <http://www.productrecords.com/philips/> today to get the very most from your purchase.

Registering your model with Philips makes you eligible for all of the valuable benefits listed below, so don't miss out. Complete and return your Product Registration Card at once or visit at www.philips.com/support to ensure:

*Product Safety Notification

By registering your product, you'll receive notification - directly from the manufacturer - in the rare case of a product recall or safety defect.

*Additional Benefits

Registering your product guarantees that you'll receive all of the privileges to which you're entitled, including special money-saving offers.

Know these **safety** symbols



The caution marking is located on the rear or bottom of the cabinet.



The lightning flash with arrowhead symbol, within an equilateral triangle, is intended to alert the user to the presence of uninsulated "dangerous voltage" within the apparatus's enclosure that may be of sufficient magnitude to constitute a risk of electric shock to persons.



The exclamation point within an equilateral triangle is intended to alert the user to the presence of important operating and maintenance (servicing) instructions in the literature accompanying the apparatus.

WARNING: To reduce the risk of fire or electric shock, do not expose this apparatus to rain or moisture. Apparatus shall not be exposed to dripping or splashing and no objects filled with liquids, such as vases, shall be placed on the apparatus.

ATTENTION: Pour éviter les choc électriques, introduire la lame la plus large de la fiche dans la borne correspondante de la prise et pousser jusqu'au fond.

PHILIPS

Visit our World Wide Web Site at www.philips.com/support

CHILD SAFETY:

It Makes A Difference How and Where You Use Your Flat Panel Display

Congratulations on your purchase!

As you enjoy your new product, please keep these safety tips in mind:



THE ISSUE

- The home theater entertainment experience is a growing trend and larger flat panel displays are popular purchases. However, flat panel displays are not always supported on the proper stands or installed according to the manufacturer's recommendations.
- Flat panel displays that are inappropriately situated on dressers, bookcases, shelves, desks, speakers, chests or carts may fall over and cause injury.

THIS MANUFACTURER CARES!

- The consumer electronics industry is committed to making home entertainment enjoyable and safe.

TUNE INTO SAFETY

- One size does NOT fit all. Follow the manufacturer's recommendations for the safe installation and use of your flat panel display.
- Carefully read and understand all enclosed instructions for proper use of this product.
- Do not allow children to climb on or play with furniture that the television set is sitting on or mounted to.
- Don't place flat panel displays on furniture that can easily be used as steps, such as a chest of drawers.
- Remember that children can become excited while watching a program, especially on a "larger than life" flat panel display. Care should be taken to place or install the display where it cannot be pushed, pulled over, or knocked down.
- Care should be taken to route all cords and cables connected to the flat panel display so that they cannot be pulled or grabbed by curious children.

WALL MOUNTING: IF YOU DECIDE TO WALL MOUNT YOUR FLAT PANEL DISPLAY, ALWAYS:

- Use a mount that has been recommended by the display manufacturer and/or listed by an independent laboratory (such as UL, CSA, ETL).
- Follow all instructions supplied by the display and wall mount manufacturers.
- If you have any doubts about your ability to safely install your flat panel display, contact your retailer about professional installation.
- Make sure that the wall where you are mounting the display is appropriate. Some wall mounts are not designed to be mounted to walls with steel studs or old cinder block construction. If you are unsure, contact a professional installer.
- A minimum of two people are required for installation. Flat panel displays can be heavy.

Important Safety Instructions

1. Read these instructions.
2. Keep these instructions.
3. Heed all warnings.
4. Follow all instructions.
5. Do not use this apparatus near water.
6. Clean only with dry cloth.
7. Do not block any ventilation openings. Install in accordance with the manufacturer's instructions.
8. Do not install near any heat sources such as radiators, heat registers, stoves, or other apparatus (including amplifiers) that produce heat.
9. Do not defeat the safety purpose of the polarized or grounding type plug. A polarized plug has two blades with one wider than the other. A grounding type plug has two blades and a third grounding prong. The wide blade or the third prong are provided for your safety. If the provided plug does not fit into your outlet, consult an electrician for replacement of the obsolete outlet.
10. Protect the power cord from being walked on or pinched particularly at plugs, convenience receptacles, and the point where they exit from the apparatus.
11. Only use attachments / accessories specified by the manufacturer.
12. Use only with the cart, stand, tripod, bracket, or table specified by the manufacturer, or sold with the apparatus. When a cart is used, use caution when moving the cart / apparatus combination to avoid injury from tip-over.



13. Unplug this apparatus during lightning storms or when unused for long periods of time.
14. Refer all servicing to qualified service personnel. Servicing is required when the apparatus has been damaged in any way, such as power-supply cord or plug is damaged, liquid has been spilled or objects have fallen into the apparatus, the apparatus has been exposed to rain or moisture, does not operate normally, or has been dropped.

Note to the CATV system installer:

This reminder is provided to call the CATV system installer's attention to Article 820-40 of the NEC that provides guidelines for proper grounding and, in particular, specifies that the cable ground shall be connected to the grounding system of the building, as close to the point of cable entry as practical.

Example of Antenna Grounding as per NEC – National Electric Code

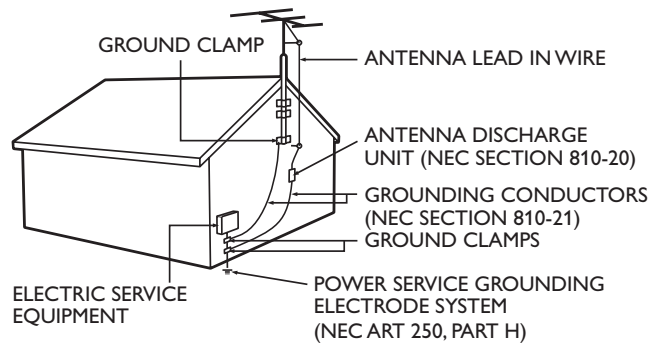

Wall Mount Bracket Kit

Brand: SANUS

Model #	Screw dimension
32PFL5708/F7 39PFL5708/F7 40PFL5708/F7 47PFL5708/F7 50PFL5708/F7	Sanus VMPL50A M6(18mm) x 2 M6(10mm) x 2 with space

- For use only with UL listed Wall Mount Bracket with minimum weight/load: please refer to below table.

Model #	minimum weight required
32PFL5708/F7	20 kg (44.1lb)
39PFL5708/F7	27.2 kg (60lb)
40PFL5708/F7	36.6 kg (80.7lb)
47PFL5708/F7	44 kg (97lb)
50PFL5708/F7	49.6 kg (109.3lb)

- The recommended Wall Mount Bracket Kit (sold separately) allows the mounting of the TV on the wall.
- For detailed information on installing the wall mount, refer to the Wall Mount Instruction Book.
- P&F USA is not responsible for any damage to the product or injury to yourself or others if you elect to install the TV on a wall mount of your own choice on your own.
- The Wall Mount Bracket must be installed by experts.

P&F USA is not liable for these types of accidents or injury noted below.

- Install the Wall Mount Bracket on a sturdy vertical wall.
- If installed onto a ceiling or slanted wall, the TV and Wall Mount Bracket may fall which could result in a severe injury.
- Do not use screws that are longer or shorter than their specified length. If screws too long are used this may cause mechanical or electrical damage inside the TV set. If screws too short are used this may cause the TV set to fall.
- Do not fasten the screws by excessive force. This may damage the product or cause the product to fall, leading to an injury.
- For safety reasons use 2 people to mount the TV onto a Wall Mounting Bracket.
- Do not mount the TV onto the Wall Mounting Bracket while your TV is plugged in or Turned On. It may result in an electrical shock injury.

When installing the unit on the wall, allow this much space.

Top:	11.8 inches (30cm)
Left and right side:	5.9 inches (15cm)
Bottom:	3.9 inches (10cm)

1 Notice

Trademarks are the property of Koninklijke Philips N.V. or their respective owners.

P&F USA reserves the right to change products at any time without being obliged to adjust earlier supplies accordingly.

The material in this User Manual is believed adequate for the intended use of the system. If the product or its individual modules or procedures are used for purposes other than those specified herein, confirmation of their validity and suitability must be obtained. P&F USA warrants that the material itself does not infringe any United States patents. No further warranty is expressed or implied.

P&F USA cannot be held responsible neither for any errors in the content of this document nor for any problems as a result of the content in this document. Errors reported to P&F USA will be adapted and published on the P&F USA support website as soon as possible.

Pixel characteristics

This LCD product has a high number of color pixels. Although it has effective pixels of 99.999% or more, black dots or bright points of light (red, green or blue) may appear constantly on the screen. This is a structural property of the display (within common industry standards) and is not a malfunction.

Warranty

No components are user serviceable. Do not open or remove covers to the inside of the product. Repairs may only be done by Service Centers and official repair shops. Failure to do so shall void any warranty, stated or implied.

Any operation expressly prohibited in this User Manual, any adjustments or assembly procedures not recommended or authorized in this User Manual shall void the warranty.

Federal Communications Commission Notice

This equipment has been tested and found to comply with the limits for a Class B Digital device, pursuant to part 15 of the FCC Rules. These limits are designed to provide reasonable protection against harmful interference in a residential installation. This equipment generates, uses and can radiate radio frequency energy and, if not installed and used in accordance with the instructions, may cause harmful interference to radio communications. However, there is no guarantee that interference will not occur in a particular installation. If this equipment does cause harmful interference to radio or television reception, which can be determined by Turning the equipment Off and On, the user is encouraged to try to correct the interference by one or more of the following measures:

- Reorient or relocate the receiving antenna.
- Increase the separation between the equipment and the receiver.
- Connect the equipment into an outlet on a circuit different from that to which the receiver is connected.
- Consult the dealer or an experienced radio or television technician for help.

Declaration of Conformity

Trade Name : PHILIPS
Responsible Party : P&F USA, Inc.
Model : 32PFL5708/39PFL5708/40PFL5708/
 47PFL5708/50PFL5708
Address : PO Box 2248, Alpharetta, GA 30023-2248
 U.S.A.
Telephone Number : 1 866 309 5962

Modifications

This apparatus may generate or use radio frequency energy. Changes or modifications to this apparatus may cause harmful interference unless the modifications are expressly approved in the User Manual. The user could lose the authority to operate this apparatus if an unauthorized change or modification is made.

Cables

Connections to this device must be made with shielded cables with metallic RFI/ EMI connector hoods to maintain compliance with FCC Rules and Regulations.

Canadian notice

This Class B Digital apparatus complies with Canadian ICES-003. Standard Television Receiving Apparatus, Canada BETS-7 / NTMR-7.

To maintain compliance with FCC RF exposure requirements, use only belt-clips, holsters or similar accessories that do not contain metallic components in its assembly. The use of accessories that do not satisfy these requirements may not comply with FCC RF exposure requirements and should be avoided.

FCC Radiation Exposure Statement

This equipment is compliance with SAR for general population/ uncontrolled exposure limits in ANSI/IEEE C95.1-1999 and had been tested in accordance with the measurement methods and procedures specified in OET Bulletin 65 Supplement C. This equipment should be installed and operated with minimum distance 2.5cm between the radiator & your body.

This device complies with Industry Canada license-exempt RSS standard(s). Operation is subject to the following two conditions: (1) this device may not cause interference and (2) this device must accept any interference, including interference that may cause undesired operation of the device.

This equipment complies with FCC radiation exposure limits set forth for an uncontrolled environment and meets the FCC radio frequency (RF) Exposure Guidelines in Supplement C to OET65. This equipment has very low levels of RF energy that it deemed to comply without maximum permissive exposure evaluation (MPE). But it is desirable that it should be installed and operated keeping the radiator at least 20cm or more away from person's body (excluding extremities: hands, wrists, feet and ankles).

Copyright

All other registered and unregistered trademarks are the property of their respective owners.



The terms HDMI and HDMI High-Definition Multimedia Interface, and the HDMI Logo are trademarks or registered trademarks of HDMI Licensing LLC in the United States and other countries.



For DTS patents, see <http://patents.dts.com>.
Manufactured under license from DTS Licensing Limited. DTS, the Symbol, & DTS and the Symbol together are registered trademarks, and DTS TruSurround is a trademark of DTS, Inc. © DTS, Inc. All Rights Reserved.



ENERGY STAR® is a joint program of the U.S. Environmental Protection Agency and the U.S. Department of Energy helping us all save money and protect the environment through energy efficient products and practices.

Consumer Notice:

This TV has been set to maximize energy efficiency while delivering the best possible picture using the factory installed home mode settings. Changing or enabling other features in this TV (e.g. brightened backlighting) will possibly increase energy consumption beyond the original ENERGY STAR® qualified limits.

2 Important

Positioning the TV

- Large screen TVs are heavy. Two people are required to carry and handle a large screen TV.
- Make sure to hold the upper and bottom frames of the unit firmly as illustrated.
- Install the unit in a horizontal and stable position.
- Do not install the unit in direct sunlight or in a place subject to dust or strong vibration.
- Depending on the environment, the temperature of this unit may increase slightly. This is not a malfunction.
- Avoid a place with drastic temperature changes.
- Do not place anything directly on top or bottom of the unit.
- Depending on your external devices, noise or disturbance of the picture and / or sound may be generated if the unit is placed too close to them. In this case, please ensure enough space between the external devices and the unit.
- Do not insert the AC power cord into the power socket outlet before all the connections are made.
- Ensure that you always have easy access to the AC power cord or plug to disconnect the TV from the power.
- Before you move the TV, disconnect attached cables to prevent damage to connectors.
- Be sure to unplug the AC power cord from the AC outlet before moving or carrying the unit.

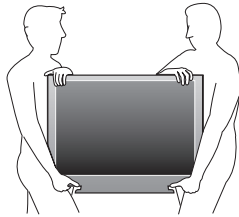

Regulatory notices

Do not place the unit on the furniture that is capable of being tilted by a child and an adult leaning, pulling, standing or climbing on it. A falling unit can cause serious injury or even death.

This apparatus should not be placed in a built-in installation such as a bookcase or rack unless proper ventilation is provided.

Make sure to leave a space of 4 inches (10cm) or more around this apparatus.

Press  to Turn the unit On and go into Standby mode.

To completely Turn Off the unit, you must unplug the AC power cord. Disconnect the AC plug to shut the unit off when trouble is found or not in use. The AC plug shall remain readily available.

Never use a gas duster on this TV.

The gas trapped inside of this unit may cause ignition and explosion.

CAUTION: Danger of explosion if battery is incorrectly replaced. Replace only with the same or equivalent type.

WARNING: Batteries (battery pack or battery installed) shall not be exposed to excessive heat such as sunshine, fire or the like.

WARNING: To prevent injury, this apparatus must be securely attached to the furniture / wall in accordance with the instructions. Tipping, shaking or rocking the unit may cause injury / death.

CAUTION: These servicing instructions are for use by qualified service personnel only. To reduce the risk of electric shock, do not perform any servicing other than that contained in the operating instructions unless you are qualified to do so.

Environmental care



The packaging of this product is intended to be recycled. Contact your local authorities for information about how to recycle the packaging. For product recycling information, please visit - www.recycle.philips.com

End of life directives



Philips pays a lot of attention to produce environment-friendly products in green focal areas. Your new TV contains materials which can be recycled and reused. At the end of its life, specialized companies can dismantle the discarded TV to concentrate the reusable materials and to minimize the amount of materials to be disposed of. Please ensure you dispose of your old TV according to local regulations.

Disposal of used batteries

The batteries supplied do not contain the heavy metals mercury and cadmium. Nevertheless, in many areas batteries may not be disposed of with your household waste. Please ensure you dispose of batteries according to local regulations.

Downloading an electronic copy

To obtain a more detailed electronic copy of this User Manual:

- 1 Point your browser to www.philips.com/support
- 2 Choose your country of location with language.
- 3 Enter the product name or number in the search field. Alternatively, you can browse the catalog.
- 4 Click the Description or Model.
- 5 Under Product support, click "User manual".

3 Get started

Features

- **DTV / TV / CATV**
You can use your remote control to select channels which are broadcast in Digital format and conventional Analog format. Also, cable subscribers can access their cable TV channels.
- **Information display**
You can display the title, contents and other information of the current program on the TV screen.
- **AutoProgram**
This unit automatically scans and memorizes channels available in your area, eliminating difficult setup procedures.
- **Child lock**
This feature allows you to block children's access to inappropriate programs.
- **Closed Caption decoder**
Built-in Closed Caption decoder displays text for Closed Caption supported programs.
- **MTS / SAP tuner**
Audio can be selected from the remote control.
- **Auto Standby**
If there is no Input signal and no operation for 15 minutes, the unit will go into Standby mode automatically.
- **Sleep timer**
You can set the unit to go into Standby mode after a specific amount of time.
- **Choices for on-screen language**
Select your on-screen language: English, Spanish or French.
- **Stereo sound function**
- **PLL frequency synthesized tuning**
Provides free and easy channel selection and lets you tune directly to any channel using the number and decimal point "•" buttons on the remote control.
- **Various adjustment for picture and sound**
Customizes image quality suitable for your room and sets your sound preference.
- **EasyLink via HDMI link**
EasyLink allows your other HDMI link devices to be controlled by the HDMI cable connected to your TV.
- **HDMI Input**
- **HDMI-DVI Input**
If your video device has DVI Output jack, use an HDMI-DVI conversion cable to connect the unit.
- **Component Video Input**
- **PC Input**
- **AV Input**
- **USB terminal**
The picture (JPEG), music (MP3) and video files stored on a USB Memory Stick can be played back on this unit.
- **Digital Audio Output**
- **Headphone Audio Output**

Supplied accessories

User Manual



Quick Start guide



Registration card



Remote Control and batteries (AAA, 1.5V x 2)



AC power cord

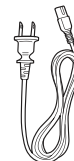

Neck

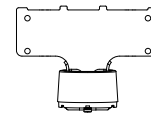

TV base and screws



Screws packed with this unit:

Model	Quantity	Size
32PFL5708/F7	4	M4 x 16
39PFL5708/F7	4	M4 x 10
40PFL5708/F7 47PFL5708/F7 50PFL5708/F7	8	M4 x 10



Note

- If you lose the screws, please purchase the above-mentioned Phillips head screws at your local store.
- If you need to replace these accessories, please refer to the part name or No. with the illustrations and call our toll free customer support line found on the cover of this User Manual.

When using a universal remote control to operate this unit.

- Make sure the component code on your universal remote control is set to our brand. Refer to the instruction book accompanying your remote control for more details.
- We do not guarantee 100% interoperability with all universal remote controls.

Symbols used in this User Manual

The following is the description for the symbols used in this User Manual. Description refers to:

Digital TV operation

Analog/Cable TV operation

- If neither symbol appears, the operation is applicable to both.

Attaching the base

You must attach the base to the unit to have it as a table top unit. Be sure the front and rear of the base match the proper direction. For large screen TVs, at least 2 people are required for these steps.

1

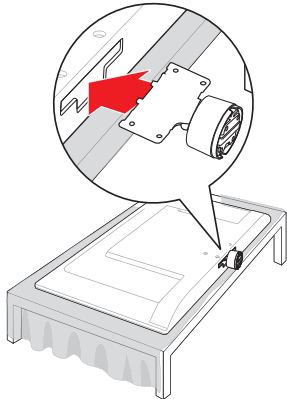

2

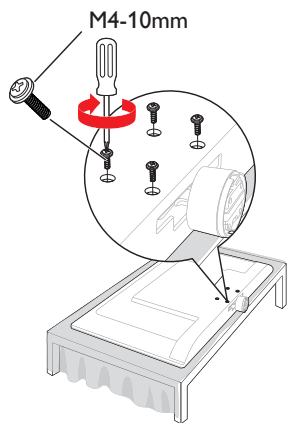

3

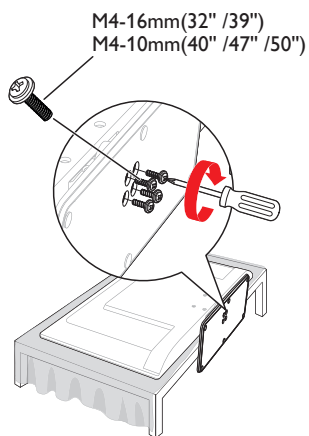

Installing the remote control batteries

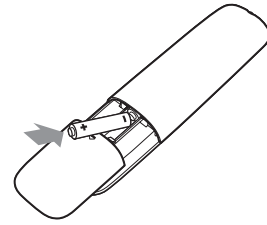

- 1 Slide the battery cover off the back of the remote control.
- 2 Insert the 2 supplied batteries (AAA, 1.5V). Be sure the + and - ends of the batteries line up with the markings inside the case.
- 3 Slide the cover back into position.

Note

- Remove the batteries if not using the remote control for an extended period of time.

Note

- Make sure to use a table which can support the weight of this unit and is larger than this unit.
- Make sure the table is in a stable location.
- When attaching the base, ensure that all screws are tightly fastened. If the base is not properly attached, it could cause the unit to fall, resulting in injuries as well as damage to the unit.
- To remove the base from this unit, unscrew the Phillips head screws in step 2. Be careful not to drop the base when you remove it.

Remote control function

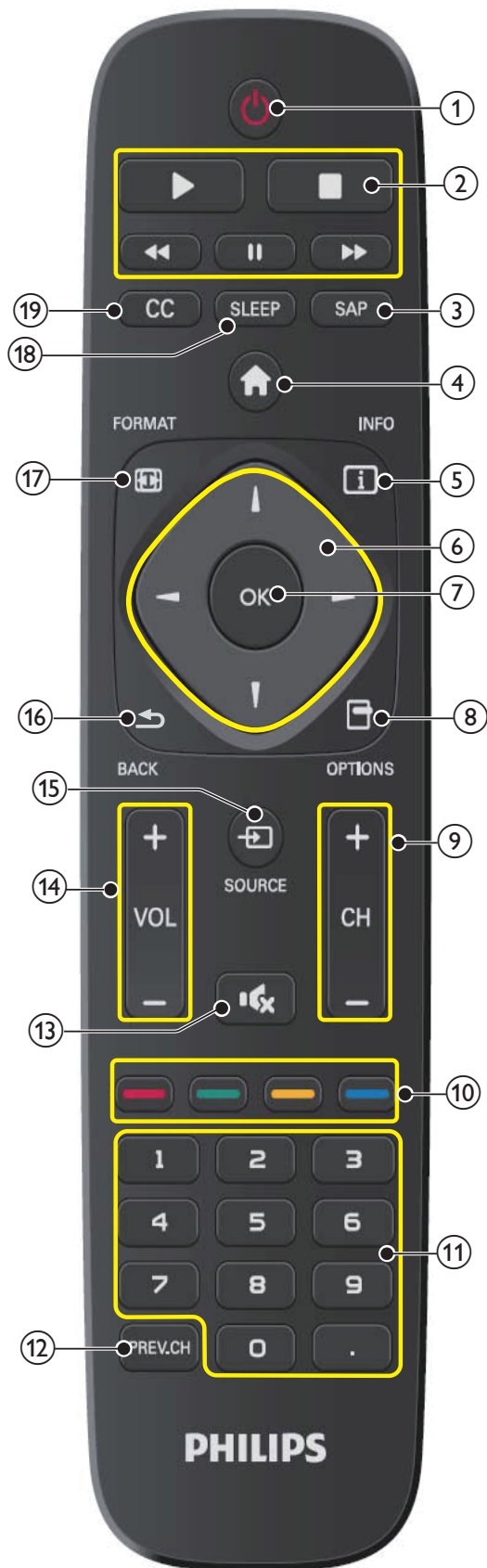

- ① **⏻ (POWER-ON / STANDBY-ON)**
Press to turn the unit On and go into Standby mode.
To completely turn Off the unit, you must unplug the AC power cord.
- ② **Playback control buttons**
Control the playback of pictures, music, videos, and DVD players when user is viewing content from connected HDMI-CEC devices.
- ③ **SAP**
Secondary Audio Programming lets you change audio language.
- ④ **🏠 (MENU button)**
Access to menu.
- ⑤ **ℹ️ INFO**
Displays information about the TV channel or accessory device.
- ⑥ **◀▶▲▼- (NAVIGATION buttons)**
Press to move left / right / up / down through the items.
- ⑦ **OK**
Press to decide the command of setting when the Home menu is displayed.
- ⑧ **☰ OPTIONS**
Displays a list of menu items applicable to connected external device.
- ⑨ **CH +/-**
Press to select channels.
- ⑩ **Color buttons**
Select tasks or options if indicated.
- ⑪ **0 - 9 (NUMBER buttons)**
Press to select channels.
• **(DOT)** Press to shift the subchannel from the main channel.
- ⑫ **PREV.CH**
Press to return to the previously viewed channel.
- ⑬ **🔇 (MUTE)**
Press to turn the sound On and Off.
- ⑭ **VOL +/- (VOLUME)**
Press to adjust the volume.
- ⑮ **📺 SOURCE**
Toggles to select connected devices.
- ⑯ **⏪ BACK**
Press to return to the previously viewed channel.
- ⑰ **🖼️ FORMAT**
Selects a picture format.
- ⑱ **SLEEP**
Press to activate the sleep timer.
- ⑲ **CC**
Press to turn Closed Control to CC On, CC Off, or CC w/mute.

Control panel

32PFL5708/F7, 39PFL5708/F7, 40PFL5708/F7,
47PFL5708/F7, 50PFL5708/F7

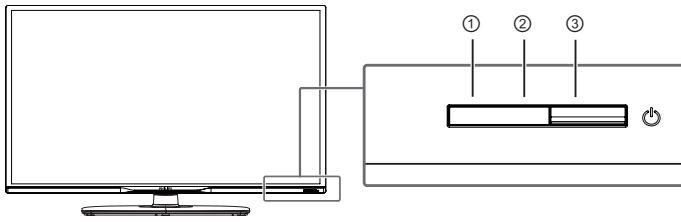

- ① **Power On indicator**
Lights up white when the unit is turned On and flashes while the unit is turning On.
- ② **Infrared sensor**
Receives IR signals from remote control.
- ③ **⏻ (POWER/STANDBY)**
Press ⏻ to turn the unit On and go into Standby mode.
To completely Turn Off the unit, you must unplug the AC power cord.

Terminals

32PFL5708/F7 and 39PFL5708/F7

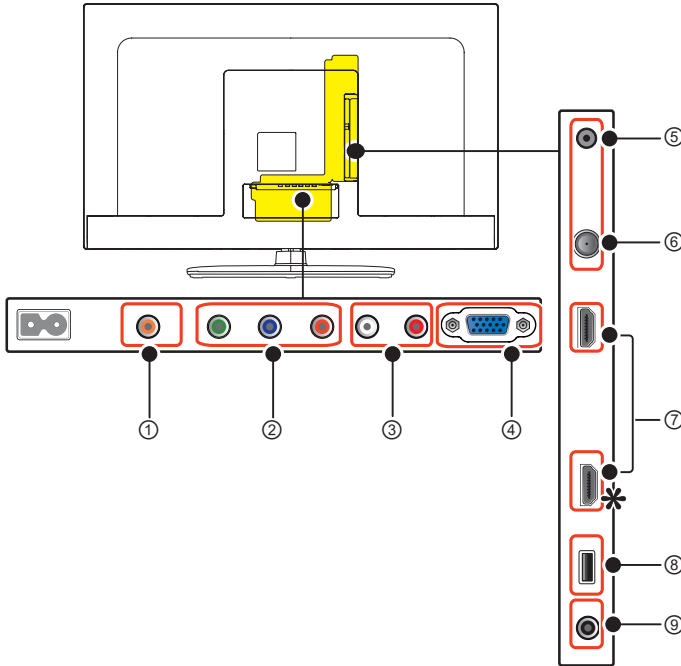

- ① **Digital Audio coaxial cable**
Digital audio output to home theaters and other digital audio systems.
- ② **Component/Composite Video Input jacks**
- ③ **Component/Composite shared Audio Input jacks**
Component/Composite analog audio (L/R) jacks signal.
- ④ **VGA cable connection for PC**
- ⑤ **Headphone Audio Output jack**
Headphone 3.5mm stereo jack for personal listening.
- ⑥ **75 ohm Cable / Antenna connection**
Signal Input from an antenna, cable or satellite.
- ⑦ **HDMI Input jacks**
Digital audio and video Input from high definition digital devices such as Blu-ray disc players, cable boxes and satellite set-top boxes.
* For HDMI 1 only
In addition to normal HDMI and HDMI-DVI functionality, it outputs TV Audio to an HDMI-ARC-compliant device, such as a home theater system.
- ⑧ **USB terminal**
Data input from USB Memory Stick only.
Do not connect any device to this terminal such as; digital camera, keyboard, mouse, etc.
- ⑨ **PC Audio Input jack**
PC analog audio jack signal with stereo mini 3.5mm plug audio cable on PC.

40PFL5708/F7, 47PFL5708/F7 and 50PFL5708/F7

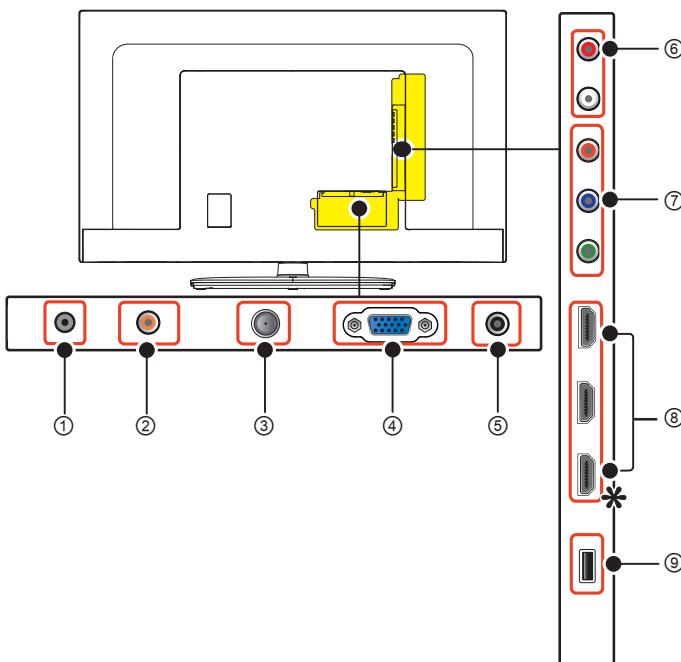

- ① **Headphone Audio Output jack**
Headphone 3.5mm stereo jack for personal listening.
- ② **Digital Audio coaxial cable**
Digital audio output to home theaters and other digital audio systems.
- ③ **75 ohm Cable / Antenna connection**
Signal Input from an antenna, cable or satellite.
- ④ **VGA cable connection for PC**
- ⑤ **PC Audio Input jack**
PC analog audio jack signal with stereo mini 3.5mm plug audio cable on PC.
- ⑥ **Component/Composite shared Audio Input jacks**
Component/Composite analog audio (L/R) jacks signal.
- ⑦ **Component/Composite Video Input jacks**
- ⑧ **HDMI Input jacks**
Digital audio and video Input from high definition digital devices such as Blu-ray disc players, cable boxes and satellite set-top boxes.
* For HDMI 1 only
In addition to normal HDMI and HDMI-DVI functionality, it outputs TV Audio to an HDMI-ARC-compliant device, such as a home theater system.
- ⑨ **USB terminal**
Data Input from USB Memory Stick only.
Do not connect any device to this terminal such as; digital camera, keyboard, mouse, etc.

Connecting the antenna or unencrypted cable

Be sure your antenna or other device is connected properly before plugging in the AC power cord.

If you connect to an antenna through RF cable

Any DTV programs that are broadcasted in your area can be received for free through an antenna connection.

For 32PFL5708/F7 and 39PFL5708/F7

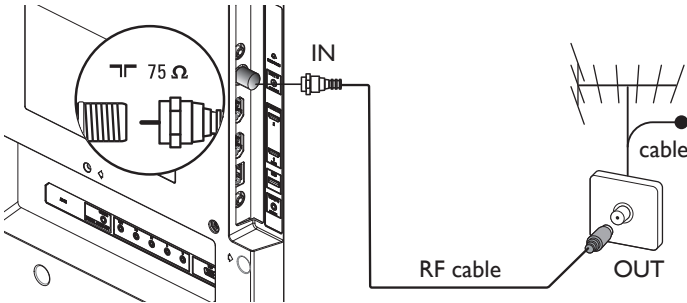

For 40PFL5708/F7, 47PFL5708/F7 and 50PFL5708/F7

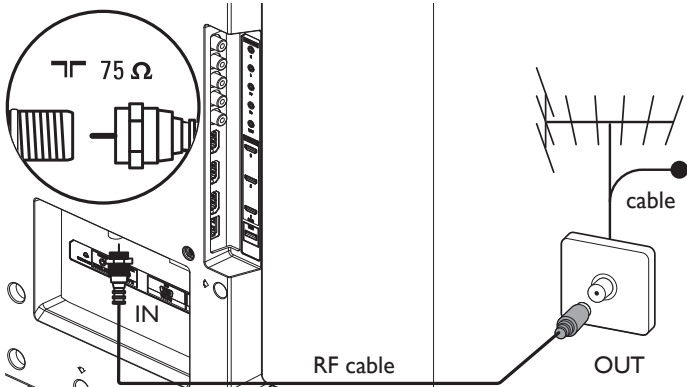

If you connect a set-top box through HDMI

If the TV is connected to a cable box or satellite set-top box via HDMI, make sure you select the correct Source by using **SOURCE**.

For 32PFL5708/F7 and 39PFL5708/F7

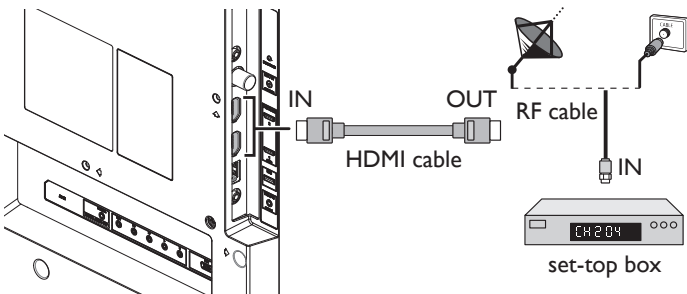

For 40PFL5708/F7, 47PFL5708/F7 and 50PFL5708/F7

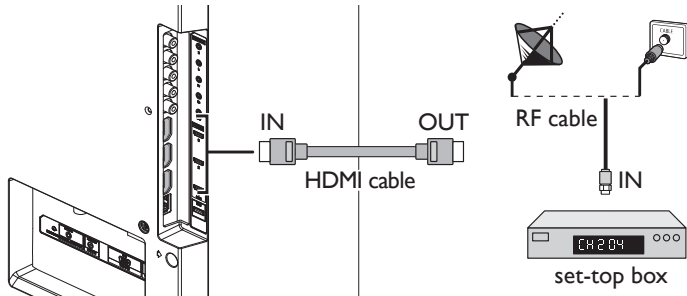

Connecting a set-top box, Blu-ray / DVD recorder via composite connectors and Analog Audio

Do not place your recorder too close to the screen because some recorders can be susceptible to signals.

For 32PFL5708/F7 and 39PFL5708/F7

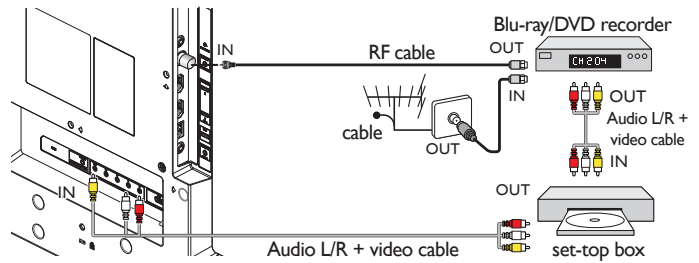

For 40PFL5708/F7, 47PFL5708/F7 and 50PFL5708/F7

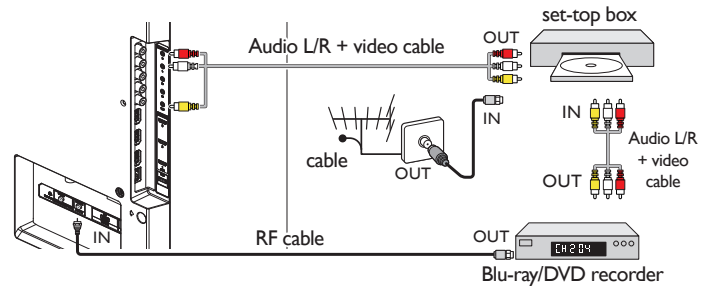

Note

- Only the left loudspeaker reproduces sound for mono equipment. Use a mono to stereo adapter (not supplied) for sound reproduction via all internal loudspeakers.
- If there is no input signal and no operation for 15 minutes, the unit will go into standby mode automatically.

Plugging in the AC power cord

Make sure that the AC power cord must be plugged to an AC outlet after all the necessary connections are made.

! Caution

- Do not connect the AC power cord to a power supply outside the indicated voltage of this unit (AC 120V).
- Connecting the AC power cord to a power supply outside of this range may result in fire or electrical shocks.

Note

- Each time you plug in the AC power cord, no operations will be performed for a few seconds. This is not a malfunction.

These operations are accessible by remote control.

Initial setup

This section will guide you through the unit's initial setting which includes selecting a language for your on-screen menu, country, location and AutoProgram, which automatically scans and memorizes viewable channels. You can also set the network connection in this setting.

Before you begin:

Make sure the unit is connected to antenna or cable.

- After making all the necessary connections, press **On** to turn On the unit.
 - It may take a few moments to turn On the unit for the first time.
 - Initial setup menu appears automatically after the unit is turned On.
- Use **▲▼** to select the on-screen language on the right side of the TV screen, then press **OK**.

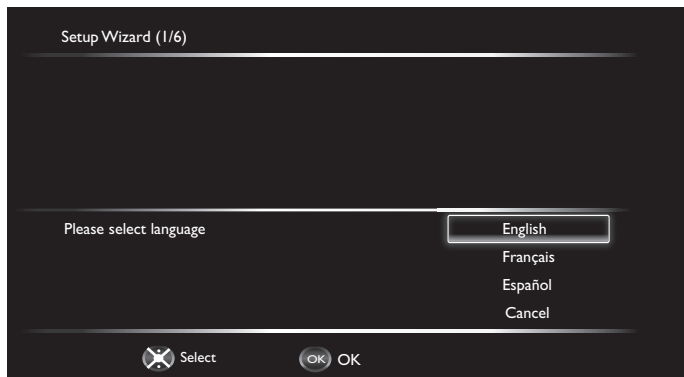

- Use **▲▼** to select the on-screen location on the right side of the TV screen, then press **OK**.
 - You must set **Home** in location setting. Otherwise, **Picture** and **Sound** settings you adjusted will not be memorized after the unit goes into Standby mode.

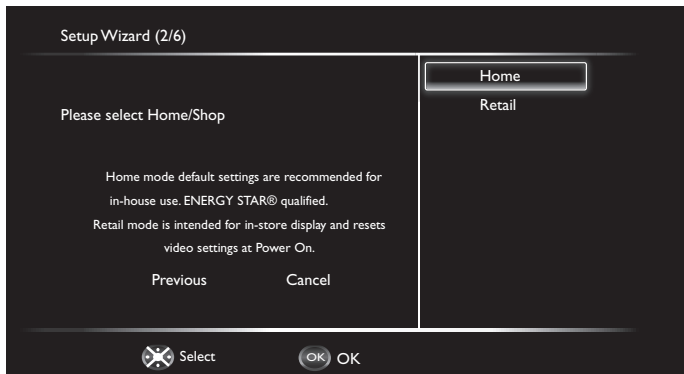

- Press **OK** to begin **Settings assistant**, then follow the on-screen instructions.

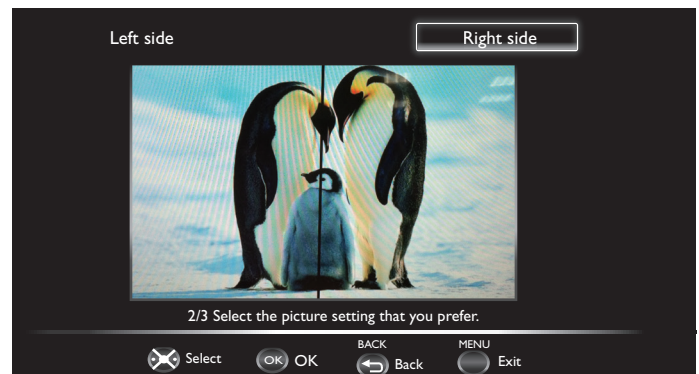
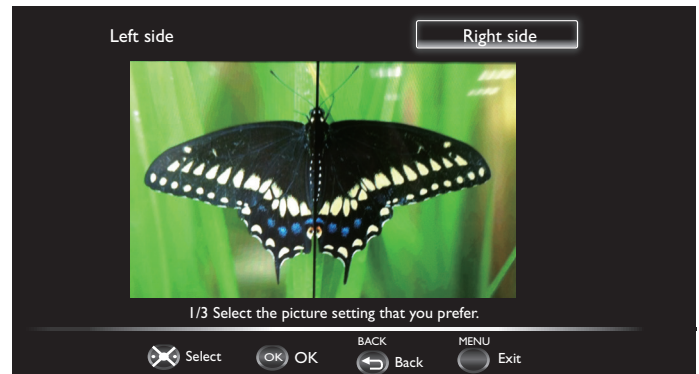
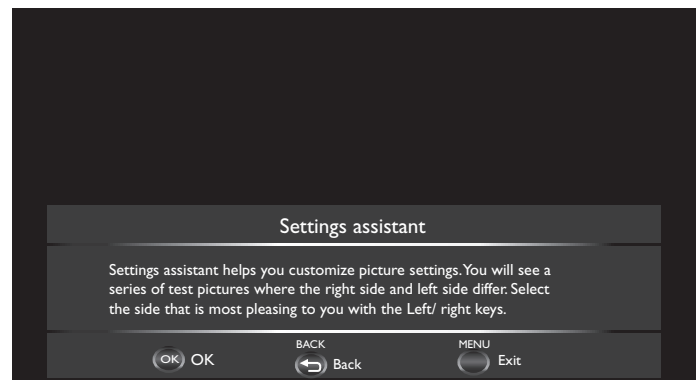

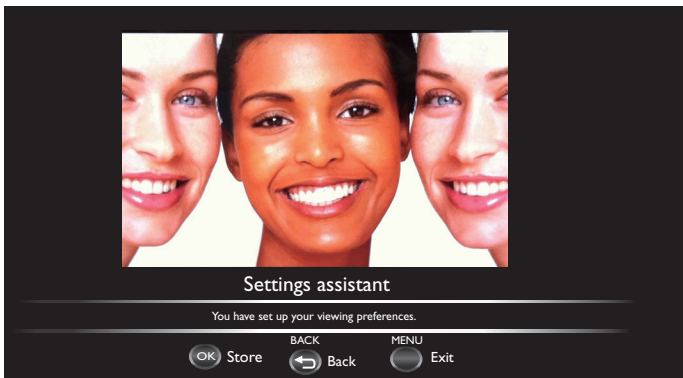

- 5 Use ▲▼ to select **Antenna** for TV channels or **Cable** for CATV channels, then press **OK**.

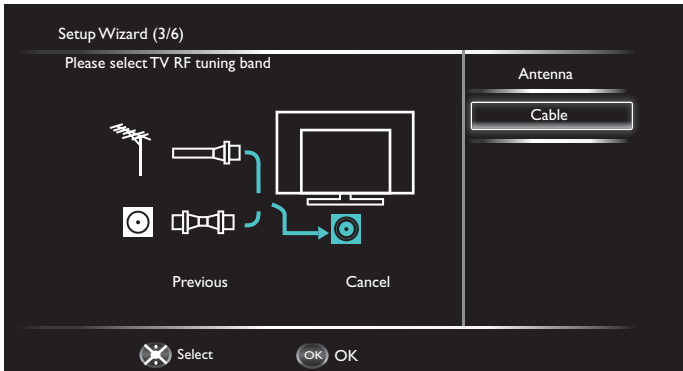

- When **Antenna** is selected, the TV detects antenna signals. It searches for DTV and Analog TV channels available in your area.
- When **Cable** is selected, the TV detects signals supplied by cable. It searches for DTV, Analog TV and Cable channels available in your area.
 - **Autoprogram** will begin.

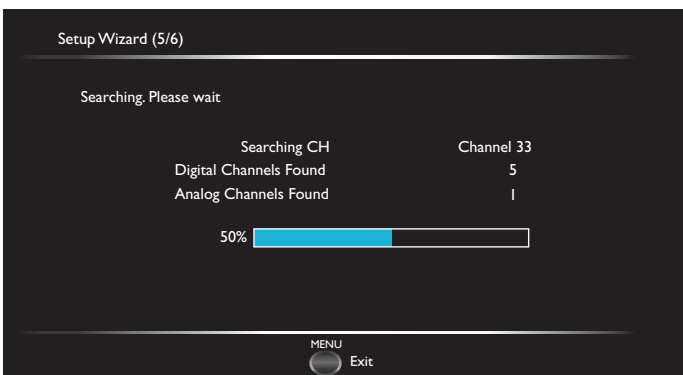

Note

- If you are not receiving a signal from your cable service, contact the Cable provider.
- If you press **⏻** during AutoProgram, this setup of TV channels will be canceled.
- The initial AutoProgram function can be executed for either **Antenna** or **Cable** only once. When you change the connection (Antenna / Cable), set **Autoprogram** again. **▶▶▶ p. 21**

After an initial setup is completed...

- If you want to scan the channels automatically again. **Autoprogram** **▶▶▶ p. 21**
- If you want to change to another language. **Language** **▶▶▶ p. 22**
- If you want to change the location setting. **Location** **▶▶▶ p. 26**
- If you want to restore the picture setting. **Settings assistant** **▶▶▶ p. 18**

4 Use your TV

Switching on your TV and putting it in Standby mode

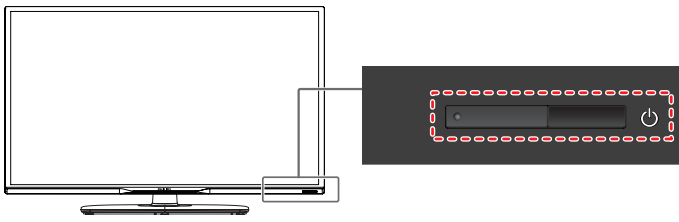

To Turn Power On or to Turn Standby On

- Press  on the panel or the remote control.

Note

- Energy consumption contributes to air and water pollution. When the AC power cord is plugged in, your TV consumes energy. Your TV has very low Standby power consumption.

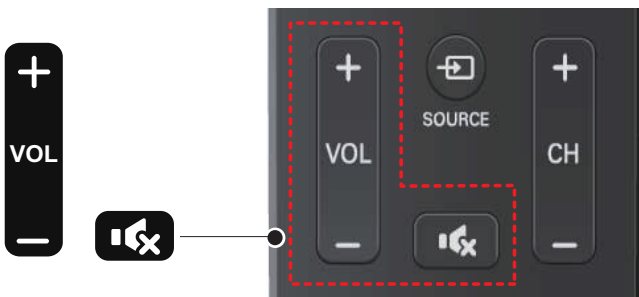

Adjusting volume



To increase or decrease volume

- Press **VOL +** / **VOL -** on the remote control.

To mute or unmute sound

- Press  (**MUTE**) on the remote control to mute the sound.
- Press  (**MUTE**) again or **VOL +** / **VOL -** to recover the original sound.

Switching channels

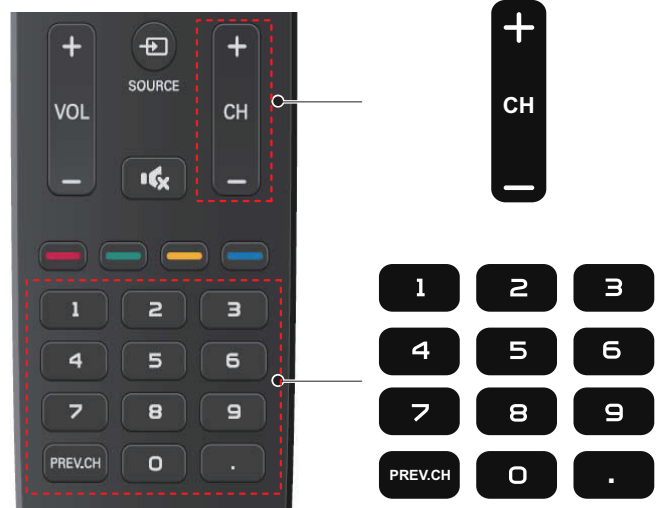

To select Channels by using CH + / CH -

- Press **CH +** (up) / **CH -** (down) on the remote control.

To select Channels by using the NUMBER buttons

Digital TV operation

- For Digital channels, press a number followed by a dot “.” and the corresponding sub channel number.
- When selecting Digital channel 11.1
Be sure to press **.** before entering the subchannel number.



Analog/Cable TV operation

- When selecting cable or Analog channel 11



Press **PREV.CH** to return to the previously viewed channel.

Note

- To select the non-memorized channels, use the **NUMBER** buttons.
- **Channel not available** or **No Signal** will appear on the TV screen after the subchannel broadcast is over.
- **Audio only** message will appear on the TV screen, when you receive only sound signal.

Watching channels from an external device

Switching each input mode can easily switch with the remote control between TV (DTV or Analog TV) and external devices when they are connected to the unit.

- 1 Turn On a set-top box or the connected device.
 - The picture from your set-top box or the connected device might appear automatically on the TV screen.

If the picture does not appear



- 2 Press **SOURCE** repeatedly to select the set-top box or the connected device, then press **OK** to enter.
 - Pressing **▲▼** to select the Input modes.

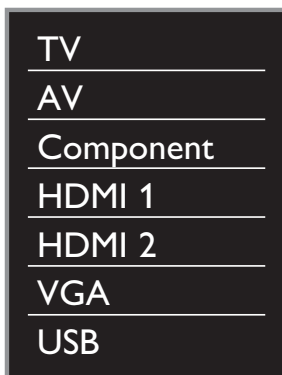

Access the Home menu

Press **HOME** (MENU) to open Home menu.

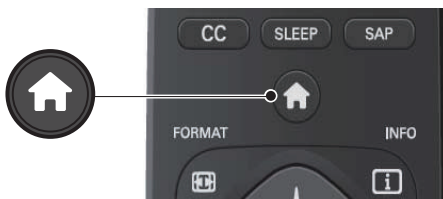

Sleep timer

Sleep timer can set the unit to go into Standby mode after an incremental period of time.

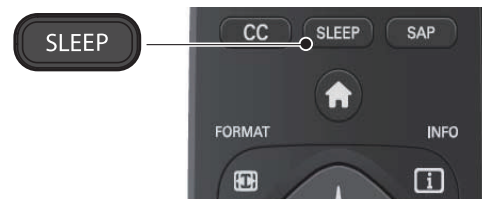

Press **SLEEP** repeatedly to change the amount of time (increases the time up to 240 minutes).

- Press **SLEEP** once to call up the display for checking the remaining time.
- To cancel sleep timer, press **SLEEP** until **Off** is displayed.

Changing picture format

Display modes can be selected when your TV receives a 16:9 or 4:3 video signal.

Three types of display modes can be selected for a PC Input signal.

Press **FORMAT** repeatedly to switch the TV aspect ratio.



For 16:9 video signal

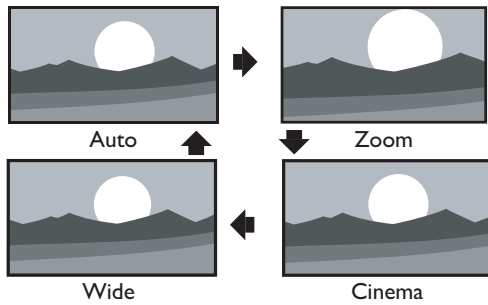

Normal	Displays a 16:9 picture at its original size
Zoom	Removes the black bars on the side of 4:3 TV broadcasts. This action will cause minimal distortion on the screen.
Wide	Displays a 16:9 picture that is stretched horizontally and vertically.
Cinema	Scales 4:3 picture format to 16:9.
Auto	Other than DTV and HDMI connected devices, enlarges the picture to best fit the screen. DTV and HDMI connected devices display the picture at its original size. The subtitles may remain visible.

For 4:3 video signal

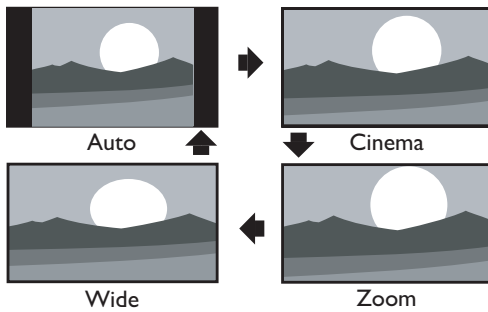

Normal	Displays a 4:3 picture at its original size
Zoom	Removes the black bars on the side of 4:3 TV broadcasts. This action will cause minimal distortion on the screen.
Wide	Displays a 4:3 picture that is stretched horizontally and vertically.
Cinema	Scales 4:3 picture format to 16:9.
Auto	Other than DTV and HDMI connected devices, enlarges the picture to best fit the screen. DTV and HDMI connected devices display the picture at its original size. The subtitles may remain visible.

For PC Input signal

- This unit can also be connected to your PC that has a DVI terminal. Use an HDMI-DVI conversion cable for this Video connection and it requires Stereo mini 3.5mm plug Audio cable for Analog Audio signal as well.
- Refer to 16:9 video signal on this page if PC has HDMI Output.

TV screen information

You can display the currently selected channel or other information such as the aspect ratio on the TV screen.

In the Digital mode, the detailed broadcasting information for the current off-the-air channel such as program title and program guides are displayed.

- 1 Press **INFO**.

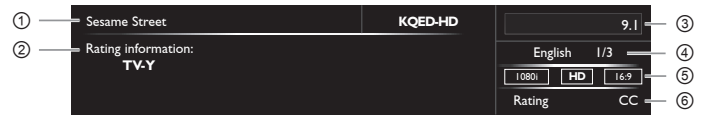
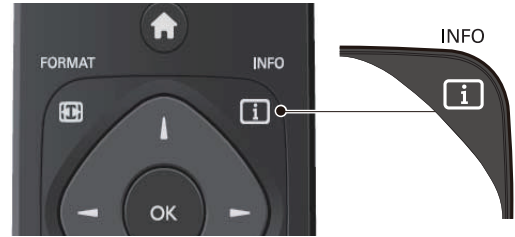

- ① program title (for DTV only)
- ② child lock rating
Child lock ➡ p. 23
- ③ channel number / Input mode
Switching channels ➡ p. 15
Watching channels from an external device ➡ p. 16
- ④ audio language (DTV) / audio mode (Analog TV)
Sound ➡ p. 20
- ⑤ program's image aspect ratio
Changing picture format ➡ p. 16
- ⑥ CC (not available if Closed Caption is set to **Off**)
Caption settings ➡ p. 25

- 2 Press **INFO** to hide the information.

Note

- While the program guide is displayed, the Closed Caption function is interrupted.
- The information display will automatically disappear in 5 seconds.

5 Use more of your TV

This section describes the overview of the **Setup** menu displayed when you press **HOME** (MENU) and use **UP** **DOWN** **LEFT** **RIGHT** to select **Setup**.

The **Setup** menu consists of the function setting items below.

1 Press **HOME** (MENU) to display Home menu.

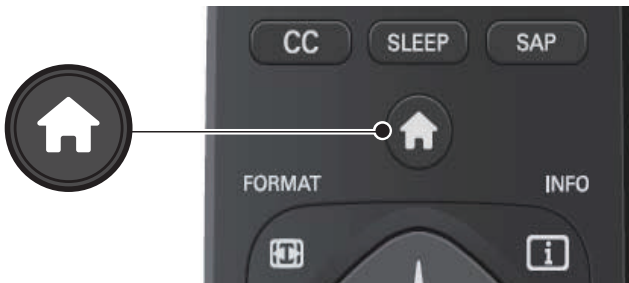

2 Use **UP** **DOWN** to select **Setup**, then press **OK**.

3 Use **UP** **DOWN** to select the desired menu and an item, then press **OK** or use **LEFT** **RIGHT** to determine the setting.

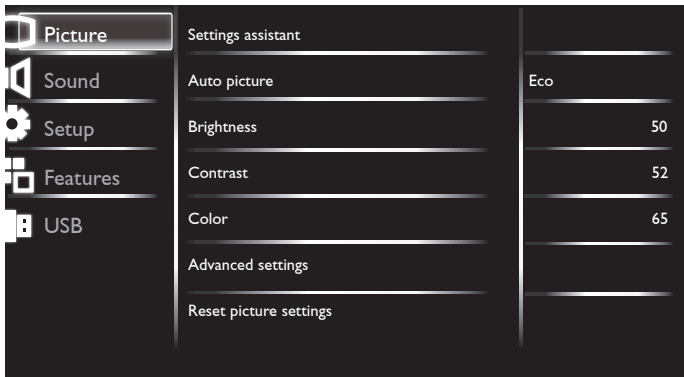

Picture

»»» p. 18

Adjusting the picture mode or customize the picture quality as your preference.

Sound

»»» p. 19

Adjusting the sound mode, equalizer and some other sound functions.

Setup

»»» p. 20

Setup allows user to do channel installation and other settings for tuner sources.

Features

»»» p. 22

Adjusting the Closed Caption, parental guide and some other useful functions.

USB

»»» p. 27

Your TV is fitted with a USB connection that enables you to view photos, listen to music or watch videos stored on a USB memory stick

4 When the setting is completed, press **HOME** (MENU) or **BACK** to exit.

Picture

Before you begin:

You must set **Home** in **Location**. »»» p. 26

Otherwise, personalized picture and sound settings will not be memorized after the unit goes into Standby mode.

1 Press **HOME** (MENU) to display Home Menu and use **UP** **DOWN** to select **Picture**, then press **OK**.

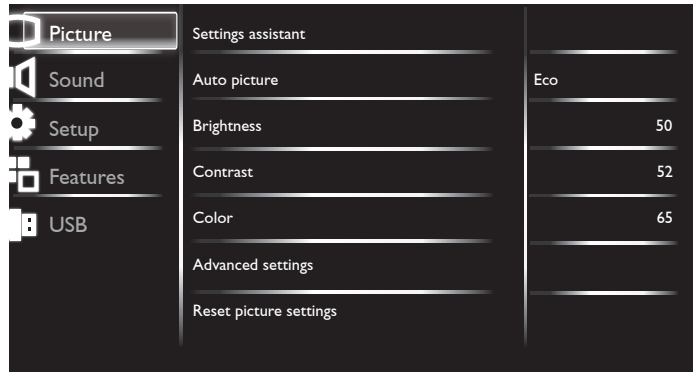

2 Use **UP** **DOWN** **LEFT** **RIGHT** to select the item you want to adjust, then press **OK**.

- The following picture settings can be configured. Depending on the format of the picture source, some picture settings are not available.

Settings assistant	to guide you through the best picture setting	
Auto picture	to select the desired setting, then press OK . (Vivid, Standard, Eco, Movie, Sports, and Personal) When you adjust the following settings, Personal will be set automatically.	
	Cursor ◀	Cursor ▶
Brightness	to decrease brightness	to increase brightness
Contrast	to decrease contrast	to increase contrast
Color	to decrease color intensity	to increase brightness

Advanced Settings	Access advanced settings.		
	Color alignment	Select a predefined color temperature, or adjust Red / Green / Blue gain and offset.	
	Noise reduction	Select the amount of noise reduction for the picture. (Off , Low , Middle , and High)	
		Cursor ◀	Cursor ▶
	Tint	to add green	to add red
	Sharpness	to soften	to sharpen
	Dynamic contrast	Dynamically enhance the details in the dark, medium, and light areas of the picture.	
	Dynamic backlight	Dynamically adjusts backlight level based on average brightness of the picture frame.	
	Aspect ratio	Select the picture ratio to suit the video source. (Normal , Zoom , Wide , Cinema , and Auto)	
	Overscan	Select to turn On or Off the overscan function.	
		Cursor ◀	Cursor ▶
Backlight	to reduce power consumption	to set the backlight brighter	
Reset Picture Settings	Select to restore the default picture settings, while channel installation settings remain the same.		



Color alignment	Color temperature mode	to set the color temperature to Cool , Normal , Warm and Personal . When you adjust the following settings, Personal will be set automatically.	
		Cursor ◀	Cursor ▶
	Red gain	to decrease contrast with red	to increase contrast with red
	Green gain	to decrease contrast with green	to increase contrast with green
	Blue gain	to decrease contrast with blue	to increase contrast with blue
	Red offset	to decrease brightness with red	to increase brightness with red
	Green offset	to decrease brightness with green	to increase brightness with green
	Blue offset	to decrease brightness with blue	to increase brightness with blue

Sound

Before you begin:

You must set **Home** in **Location**. p. 26

Otherwise, personalized picture and sound settings will not be memorized after the unit goes into Standby mode.

- 1 Press **▲** (MENU) to display **Home Menu** and use **▲▼** to select **Sound**, then press **OK**.
- 2 Use **▲▼◀▶** to select the item you want to adjust, then press **OK**.
 - The following sound settings can be configured. Depending on the sound source, some sound settings are not available.

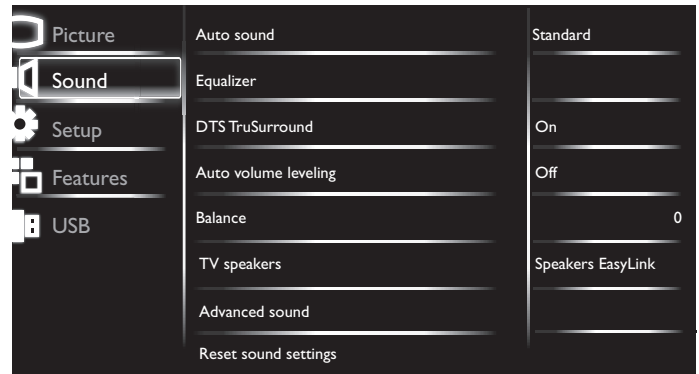

Auto sound	to select the desired setting, then press OK (Standard , Movie , Music , Sports , News , and Personal)	
Equalizer	to select the specific frequency and use ◀▶ to adjust the level, then press OK	
DTS TruSurround	Enable DTS TruSurround to enhance your audio experience.	
Auto volume leveling	Dynamically adjusts volume across different channels and sources to maintain a consistent level.	
Balance	Adjust the balance of the right and left speakers to best suit your listening position.	
TV speakers	Select On to output sound from TV speakers, Off to manually turn off TV speakers and enable Digital Audio Output. Speakers EasyLink uses HDMI-CEC to automatically turn off TV speakers and direct sound to connected HDMI-CEC compliant Home Theater System using HDMI-ARC or Digital Audio Port if it detects one.	
Advanced sound	Digital output format	Select the type of digital audio output: Bitstream , PCM .
	Audio setting	Select the audio mode from: Mono , Stereo , and SAP . For use of Analog TV only.
	Audio Language	You can select your preferred audio language when TV channel broadcasts multiple/dual audio languages.
Reset sound settings	Select to restore the default sound settings, while channel installation settings remain the same.	

Analog/Cable TV operation

You can select **Mono** or **Stereo** if the Analog broadcasting is sending the MTS (Multi channel television sound).

You can select **SAP** while your TV is receiving the Analog broadcasting that has the SAP (Second Audio Program).

Audio setting	Mono	to output mono-audio
	Stereo	to output stereo-audio
	SAP	to output second-audio program

You can set the digital audio output format.

Digital output format	PCM	to output PCM
	Bitstream	to output Bitstream (When the audio of the content is PCM, it will be output in PCM even if Bitstream is selected.)

Digital TV operation

You can select the Audio language while your TV is receiving the Digital broadcasting.

Audio Language	to select the language according to your preference. (It differs depending on the program.)
----------------	---

Setup

Note

- The **Setup** menu item is disabled for non-tuner sources..

Setup allows user to do channel installation and other settings for tuner sources.

- Press **HOME** (MENU) to display **Home Menu** and use **▲▼** to select **Setup**, then press **OK**.

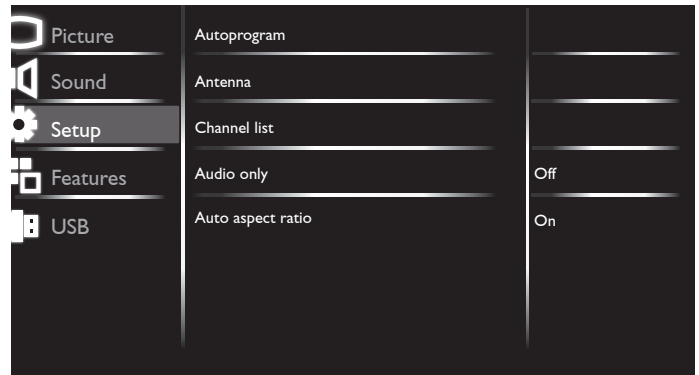

- Use **▲▼◀▶** to select the item you want to adjust, then press **OK**.

Autoprogram	Select one option to install channels: Antenna or Cable .
Antenna	This item is only applicable when input source is in DTV. A Channel Strength menu will appear on the TV screen indicating the signal strength of DTV.
Channel list	Displays a list of available channels.
Audio only	Select to turn off the panel screen and keep only the sound on.
Auto aspect ratio	Select On to select the appropriate video aspect ratio based on information present in input MPEG stream from tuner source. Selecting Off uses TV's current Aspect ratio setting.

Autoprogram

If you switch wires (e.g. between antenna and CATV) or if you move the unit to a different area after the initial setting, or if you restore the DTV channels you deleted, it is recommended to use AutoProgram to perform a new channel search.

- 1 Press **⏠** (MENU) to display **Home Menu** and use **▲▼** to select **Setup**, then press **OK**.
- 2 Use **▲▼** to select **Autoprogram**, then press **OK**.
- 3 Use **▲▼** to select **Cable** or **Antenna**, then press **OK**.
- 4 Press **OK** to select **Start now**.
 - **Autoprogram** will start automatically.

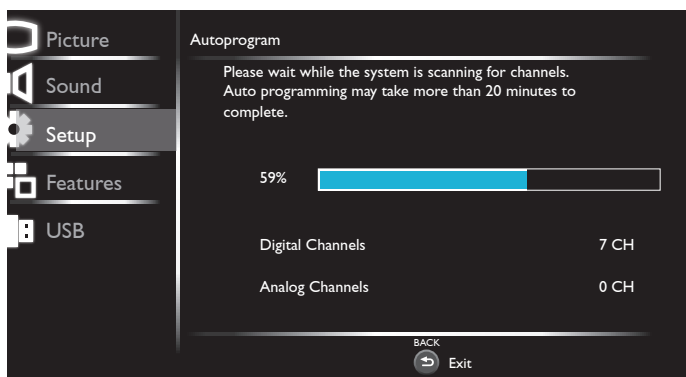

- 5 Follow the on-screen instructions to complete the installation.

Note

- After setting **Autoprogram**, using **CH + / CH -** skips unavailable programs automatically.
- If you are not receiving a signal from your cable service, contact the cable provider.
- If you press **⏏** or during **Autoprogram**, the setup of TV channels will be canceled.
- Even if **Autoprogram** is completed, the channel setting will be lost if the AC power cord is unplugged before the unit goes into Standby mode by pressing **⏏**.
- The PIN code will be required once you set a PIN code in the **Child lock**. **▶▶▶▶▶ p. 23**
- If you want to change your PIN code, follow the instruction of **Change PIN**. **▶▶▶▶▶ p. 25**

Channel list

You can make a list of your preferred TV channels so that you can find those channels more easily.

- 1 Press **⏠** (MENU) to display **Home Menu** and use **▲▼** to select **Setup**, then press **OK**.
- 2 Use **▲▼** to select **Channel list**, then press **OK**.

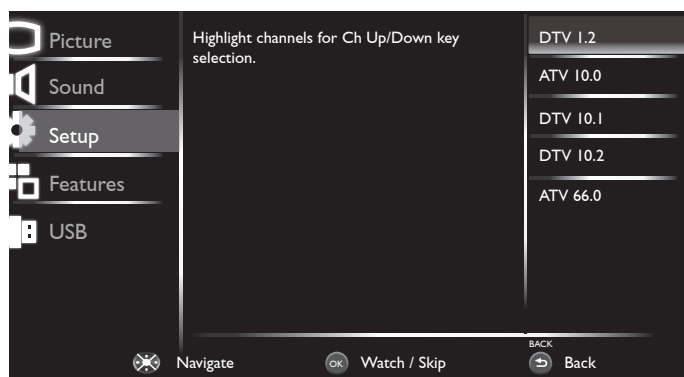

- 3 Use **▲▼** to select the desired channel, then press **OK** repeatedly to switch between skip/watch.
 - The greyed out channels indicates exclusion, which means those channels will be skipped when using **CH + / CH -** key (on your TV remote control) for channel browsing.
 - The white channels indicates inclusion, which means those channels will be shown when using **CH + / CH -** key (on your TV remote control) for channel browsing.

Features

- 1 Press **⬆** (MENU) to display **Home Menu** and use **▲▼** to select **Features**, then press **OK**.

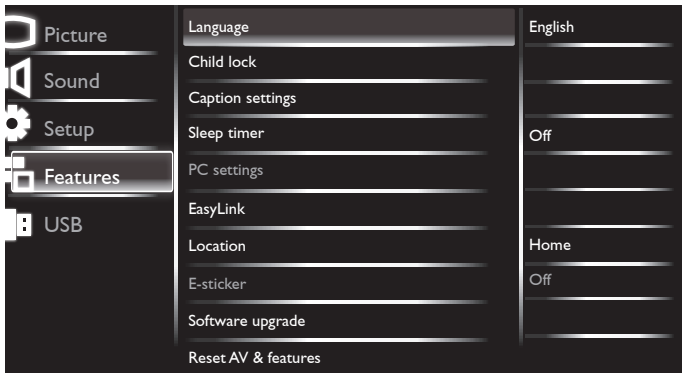

- 2 Use **▲▼◀▶** to select the item you want to adjust, then press **OK**.

Language	Select a menu language from the list, then press OK : English , Español , and Français .
Child lock	This interface offer a variety of features to limit child's access to inappropriate TV contents. Please refer to the section of Child lock on p. 23 for detailed information.
Caption settings	Please refer to the section of Caption settings on p. 25 for detailed information.
Sleep timer	You can switch the TV to standby after a specified time. During the countdown to the specified time, you can switch off your TV earlier or reset the sleep timer. Select a value between Off ~ 240 min .
PC settings	Accesses options of PC-related settings. You can make adjustments in: Horizontal position , Vertical position , Clock , and Phase by using the on-screen cursor bars when PC is connected to the TV. You can also select Auto adjustment , the option will automatically adjust the picture position. Select Reset PC settings to reset the memory of PC settings.
EasyLink	You can get the most out of your HDMI-CEC-compliant devices with Philips EasyLink enhanced control features. Connect your HDMI-CEC compliant devices through HDMI to your TV and control them at the same time with your TV remote control. For detailed information, please refer to the section of EasyLink on p. 26 .
Location	Select Home or Retail as the location mode for your TV. For detailed information, please refer to the section of Location on p. 26 .
E-sticker	Enables or disables E-sticker. Only available when Location is in Retail mode.
Software upgrade	You can download the upgrade file from our official website to your USB. Connect the USB to your TV and select Software upgrade , then follow the on-screen instructions to upgrade the TV software.
Reset AV & features	You can reset the AV & Features memory completely, including your Child Lock PIN code.

Language

- 1 Press **⬆** (MENU) to display **Home Menu** and use **▲▼** to select **Features**, then press **OK**.
- 2 Use **▲▼** to select **Language**, then press **OK**.

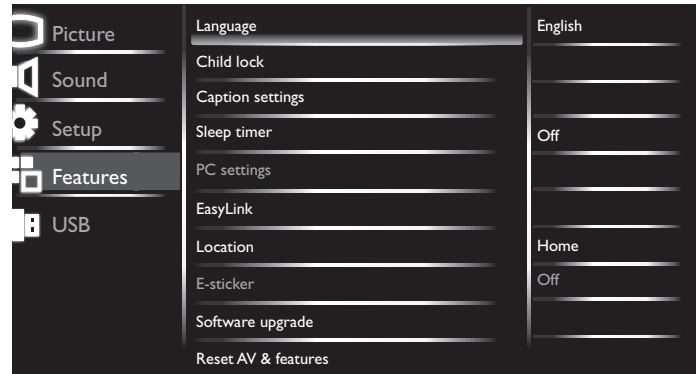

- 3 Use **▲▼** to select **English**, **Français**, or **Español**, then press **OK**.

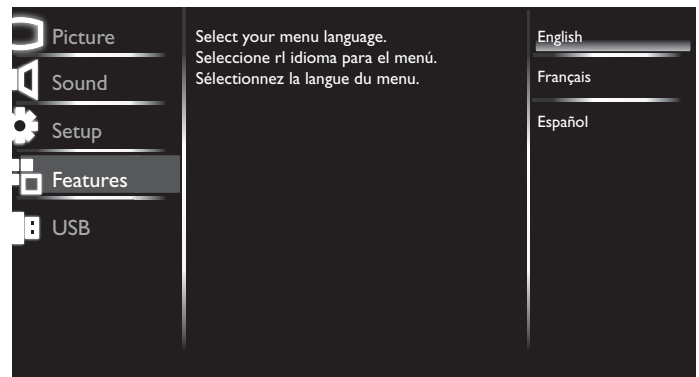

Child lock

You can prevent your children from watching certain programs or certain channels by locking the TV controls and by using ratings.

- 1 Press **HOME** (MENU) to display **Home Menu** and use **▲▼** to select **Features**, then press **OK**.
- 2 Use **▲▼** to select **Child lock**, then press **OK**.

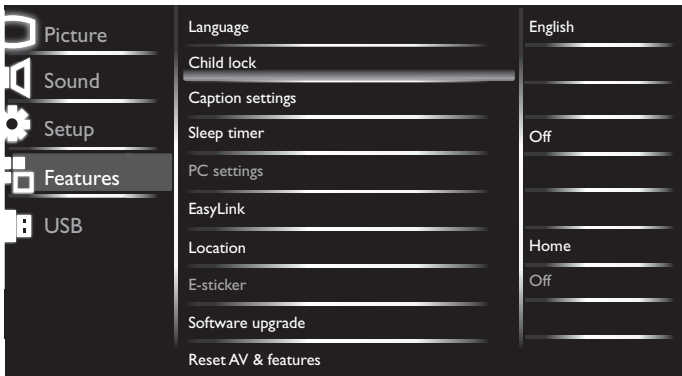

- 3 Use the **NUMBER** buttons to enter the 4-digit numbers for your PIN code.
 - When you have not set up your PIN code, enter **0, 0, 0, 0**.

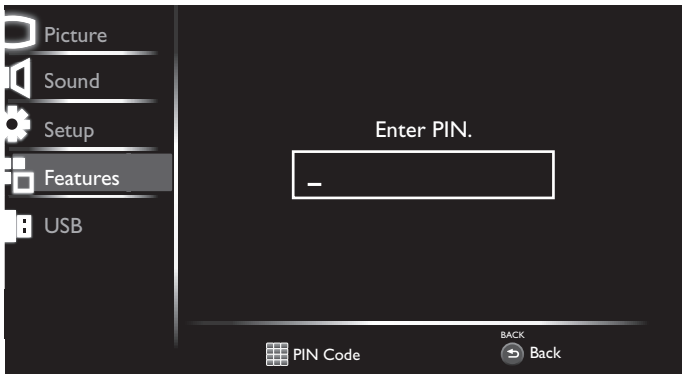

- When the PIN code is correct, **Child lock** menu is displayed. See the following description for setting each item.

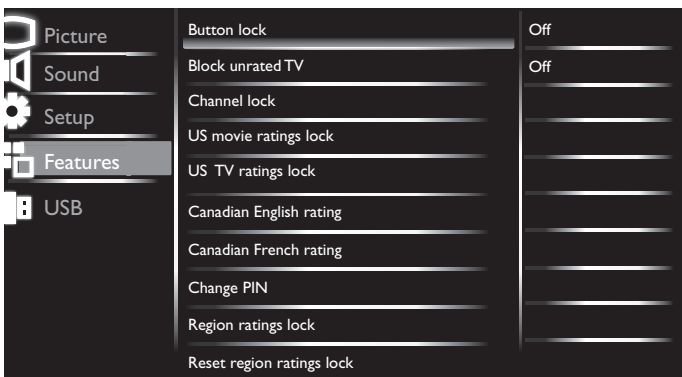

Note

- When you select the higher rating and set it to , the lower ratings will be blocked automatically.
- When you set the **All** to , all ratings return to automatically.
- **Region ratings lock** will be available when the unit receives a Digital broadcast using the new rating system.
- To block any inappropriate programs, set your limits in **US TV ratings lock**, **US movie ratings lock** and **Region ratings lock**.

Channel lock

Particular channels or external Input modes can be invisible in this function.

- 1 Use **▲▼** to select **Channel lock**, then press **OK**.
- 2 Use **▲▼** to select the particular channels or external Input, then press **OK** repeatedly to switch between view and block.
 - indicates that the channel or Input Source is locked.
 - indicates that the channel or Input Source is not locked.

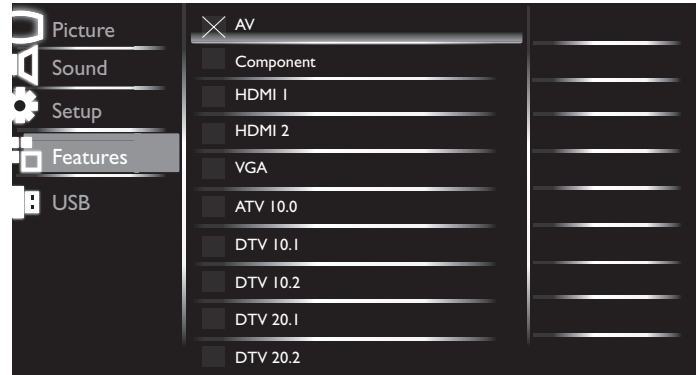

USTV and movie ratings

Movie ratings lock is the rating system created by MPAA. TV ratings lock has controlled access to individual programs based on their age ratings and content rating.

- 1 Use **▲▼** to select **US movie ratings lock** or **USTV ratings lock**, then press **OK**.
- 2 Use **▲▼** to select the desired rating, then press **OK** repeatedly to switch between view and block.
 - indicates that the rating is locked.
 - indicates that the rating is not locked.

US movie ratings lock



US movie ratings	US TV ratings	Description
All		All ratings locked including no rating
NR	None	No rating
-	TV-Y	Appropriate for all children
-	TV-Y7	Appropriate for all children 7 and older
G	TV-G	General audience
PG	TV-PG	Parental guidance suggested
PG-13	-	Unsuitable for children under 13
-	TV-14	Unsuitable for children under 14
R	-	Restricted under 17 requires accompanying parent or adult guardian
NC-17	-	No one under 17 admitted
X	TV-MA	Mature audience only

US TV ratings lock

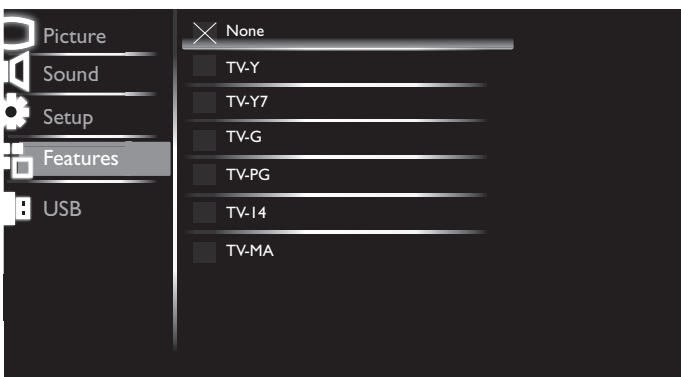

US TV ratings	Sub Rating
TV-Y7	Fantasy Violence
TV-PG	Dialog Language
TV-14	Sex Violence
TV-MA	Language Sex Violence

Note

- Blocked sub rating will appear beside the main rating category in US TV ratings lock menu.
- You cannot block a sub rating if the main rating is set to .
- Changing the category to or automatically changes all its sub ratings to the same (or .

Canada English or Canada French ratings

You can select the rating for Canada English or Canada French broadcasting.

- Use **▲▼** to select **Canada English ratings** or **Canada French ratings**, then press **OK**.
- Use **▲▼** to select the desired rating, then press **OK** repeatedly to switch between view and block.
 - indicates that the rating is locked.
 - indicates that the rating is not locked.

Canada English rating	Canada French rating	Description
All		Locked all ratings
E		Exempt program
C	-	For all children
C8+	-	For children over 8
G		General audience
-	8ans+	Unsuitable for ages under 8
PG	-	Parental guidance suggested
-	13ans+	Unsuitable for ages under 13
14+	-	Unsuitable for ages under 14
-	16ans+	Unsuitable for ages under 16
18+	18ans+	Adult audience only

Note

- The V-Chip can block non rated programs as per "CEA-608-E sec. L3". If the option to block NR, None or E programs is used in **US movie ratings lock**, **US TV ratings lock**, **Canada English rating** or **Canada French rating** accordingly "unusual results may occur and the unit may not receive emergency bulletins or other types of programming:" / Emergency Bulletins (Such as EAS messages, weather warnings and others) / Locally originated programming / News / Political / Public Service Announcements / Religious / Sports / Weather.

Change PIN

Although the default PIN code (0000) is supplied with the unit, you can set your own PIN code.

- Use ▲▼ to select **Change PIN**, then press **OK**.
- Press the **NUMBER** buttons to enter the new 4-digit PIN code.
 - Enter PIN code again to confirm.

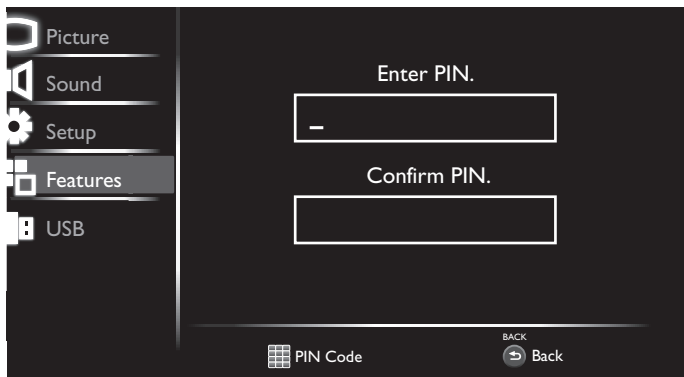

Note

- Make sure new PIN code and confirm PIN code must be exactly the same. If they are different, the space is cleared for reentering.
- If you have forgotten your PIN code, enter 9999 to reset the PIN code.

Caption settings

Closed Captioning displays the Audio portion of programming as text superimposed over the video.

- Press **HOME** (MENU) to display **Home Menu** and use ▲▼ to select **Features**, then press **OK**.
- Use ▲▼ to select **Caption settings**, then press **OK**.
 - [Caption control]**: Use ▲▼ to select, then select **CC Off**, **CC On** or **CC on w/mute**, then press **OK**.

Analog/Cable TV operation

- [Analog captions]**: Use ▲▼ to select, then select the desired caption from **CC1~CC4** or **Text1~Text4**, press **OK**. This option is only available in ATV and CVBS.

CC1 and Text1	The primary caption and text services. The captioning or text is displayed in the same language as the program's dialog (up to 4 lines of script on the TV screen).
CC3 and Text3	Serve as the preferred data channels. The captioning or text is often a secondary language.
CC2, CC4, Text2 and Text4	Rarely available and broadcasters use them only in special conditions, such as when CC1 and CC3 or Text1 and Text3 are not available.
	• There are 3 display modes according to programs:
	Paint-on Displays input characters on the TV screen immediately.
	Pop-on Once characters are stored in memory, they are displayed all at once.
	Roll-up Displays the characters continuously by scrolling (max. 4 lines).

Digital TV operation

- [Digital captions]**: Use ▲▼ to select, then select the desired digital caption service from **CS1~CS6** or **CC1~CC4**, press **OK**. This option is only available in DTV.

In addition to the basic Closed Caption, DTV has its own Closed Caption called Digital caption service. Use this menu to change the settings for Digital caption service.

Digital caption service	CS-1 to CS-6	Selects one of these before changing any other item in Caption settings menu. Choose CS-1 under normal circumstances.
--------------------------------	----------------------------------	--

You can choose the size, font, color, background and other characteristics of the caption text.

- [Caption style]**: Use ▲▼ to select, first enable **User Setting**, then shift back to previous level of options.
- Use ▲▼ to select an item and press **OK**, then use ▲▼ to select the desired setting and press **OK**.

Caption style	User setting	You can reset the status of Caption style .
		You can change Closed Captioning font size, style, color and transparency. (Font Size , Font Style , Font Color , and Font opacity)
		You can change background color and transparency of the displayed caption. (Background color and Background opacity)
		You can change edge color and type of the displayed caption. (Edge type and Edge color)

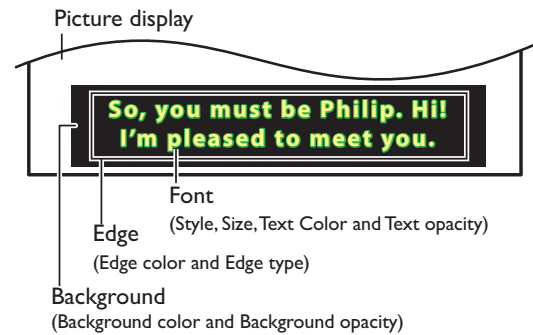

- Review your setting choice made before by looking in the upper left corner of the displayed setting box (not all selections show the differences selected).

Note

- Closed Captioning service may not be controlled by this unit's menu options if you are watching television through an external cable or satellite set-top box. In which case you will need to use the menu options on the external set-top box to control Closed Captioning.
- The captions do not always use correct spelling and grammar.
- Not all TV programs and product commercials include Closed Caption information. Refer to your area TV program listings for the TV channels and times of Closed Caption shows. The captioned programs are usually noted in the TV listings with service marks such as **CC**.
- Not all captioning services are used by a TV channel during the transmission of a Closed Caption program.

Sleep timer

Sleep timer can set the unit to go into Standby mode after an incremental period of time.

- 1 Use ▲▼ to select **Sleep timer**, then press **OK**.
- 2 Use ▲▼ to select a value between off and 240 min.

Note

- You can also press **SLEEP** directly to switch the desired setting. p. 10

EasyLink

This function allows you to operate the linked functions between our brand devices with a EasyLink feature and this unit connecting through an HDMI cable. You must connect this unit to our brand EasyLink devices and be sure its EasyLink setting is also set to On.

- 1 Press **HOME** (MENU) to display **Home Menu** and use ▲▼ to select **Features**, then press **OK**.
- 2 Use ▲▼ to select **EasyLink**, then press **OK**.
- 3 Use ▲▼◀▶ to select the item you want to adjust, then press **OK**.



Set the **Master EasyLink** to **On** or **Off**. The following additional settings will be grayed out when you set to **Off**.

Master EasyLink	Off	Disables all EasyLink.
	On	Selects if you have connected an external device that is compatible with the EasyLink function.

Automatically turn off your connected EasyLink device when the TV is turned off.

Auto device off	Off	Your connected EasyLink device stays in original mode, even if the TV is turned off.
	On	This unit turns to Standby mode automatically when your connected EasyLink device has been inactive.

This unit will turn On when the power On signal is sent from your connected EasyLink device.

Auto TV on	Off	This unit stays in Standby mode even if you Turn On your connected EasyLink device.
	On	This unit turns On automatically when you turn On your connected EasyLink device.

Device list

This function lets you see the product model number or name of connected devices.

Use ▲▼ to select the desired EasyLink device listed on the TV screen, then press **OK**.

Your connected EasyLink device will be turned On if the device is in Standby mode.

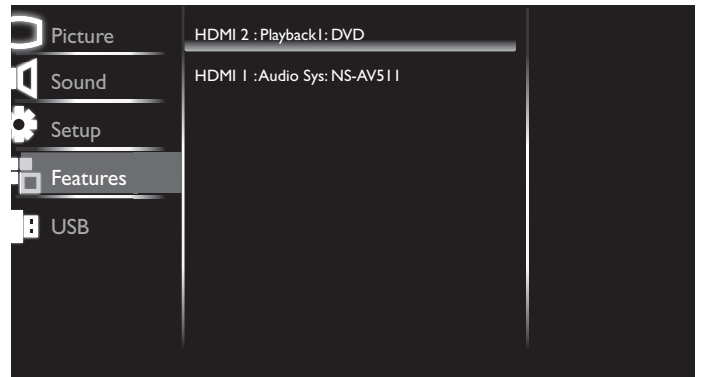

Location

Choosing **Home** gives you full flexibility to change predefined settings for picture and sound.

- 1 Press **HOME** (MENU) to display **Home Menu** and use ▲▼ to select **Features**, then press **OK**.
- 2 Use ▲▼ to select **Location**, then press **OK**.



- 3 Use ▲▼ to select **Home**, then press **OK**.

Retail	The unit will be set up with predefined settings for retail displays. In this setting, the power consumption may possibly exceed the limit requirement of the ENERGY STAR® qualification.
Home	This setting is ENERGY STAR® qualified. The unit is set to maximize the energy efficiency for home setting and it can be adjusted through a choice of picture and sound quality according to your preference.

Note

- You must set **Home**. Otherwise, personalized picture and sound settings will not be memorized after the unit goes into Standby mode.

E-sticker

When you set **Location** to **Retail**, E-sticker (Electronic Sticker) is displayed. E-sticker can be turned Off using procedure below.

- 1 Use ▲▼ to select **E-sticker**, then press **OK**.
- 2 Use ▲▼ to select **Off**, then press **OK**.

USB

Your TV is fitted with a USB connection that enables you to view photos, listen to music or watch video files stored on a USB Memory Stick.

- 1 Connect the USB Memory Stick to the USB terminal on the side of your TV.
- 2 Press **HOME** (MENU) to display **Home Menu** and use ▲▼ to select **USB**, then press **OK**.

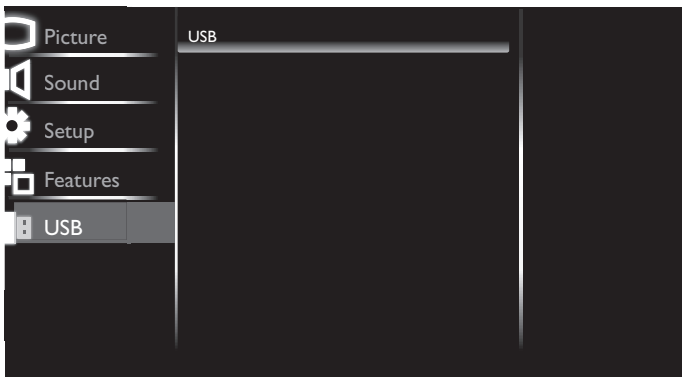

- 3 Use ◀▶ to select the **PHOTO**, **MUSIC**, or **MOVIE**, then press **OK**.

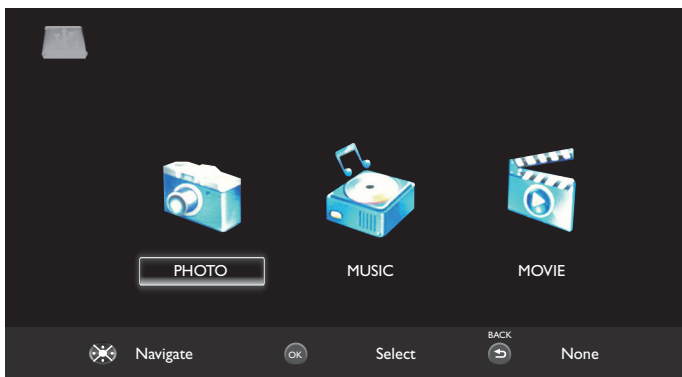

- Files encoded in the following formats are supported.
- The files recorded under the following specifications are required.

PHOTO					
Image	Photo	Resolution	Req. DRAM size(MB)	width	height
JPEG	Base-line	15360x8660	3.96	15360	8640
	Progressive	1024x768	6	1024	768

	File Extension	Container	Codec	
	Video		Audio	
VIDEO	dat, mpg, mpe	MPEG, MPEG	MPEG1, 2	
	ts, trp, tp, m2ts	MPEG2 -TS	MPEG2 H.264	
	vob	MPEG2 -PS	MPEG2	
	mp4	MP4	MPEG4 H.264	
	mkv	MKV	MPEG1, 2, 4 H.264	
	avi	AVI	MPEG2, MPEG4 H.264	
	avi, mov	Motion JPEG	JPEG	
			MPEG1 layer 2, MPEG1 layer 3, MPEG2 layer 3, AC-3, LPCM, ADPCM	

Music (MP3)	
MPEG1 Layer 2	32Kbps ~ 448Kbps(Bit rate) 32KHz ~ 48KHz(Sampling rate)
MPEG1 Layer 3	32Kbps ~ 320Kbps(Bit rate) 32KHz ~ 48KHz(Sampling rate)
MPEG2 Layer 3	32Kbps ~ 320Kbps(Bit rate) 32KHz ~ 48KHz(Sampling rate)

Note

- This unit accepts USB memory stick only. Other storage devices such as external HDD by USB bus power will not work.
- Do not use an extension cord and USB Hub to connect devices to this unit. Always insert the USB flash memory in to this unit directly.
- We cannot be held responsible if your USB memory stick is not supported, nor will we accept any liability for damage or loss of stored data.
- The USB memory stick is not supplied with this TV.
- A maximum of 1,023 folders or files can be recognized.
- A file name exceeding 256 characters or contains a dot character is not supported on this TV.
- AAC / HE-AAC audio format playback is not supported in music mode or in video files.
- Progressive JPEG files with a resolution of greater than 1024x768 are not supported.

PHOTO

1 Use ▲▼◀▶ to select a file or a folder.

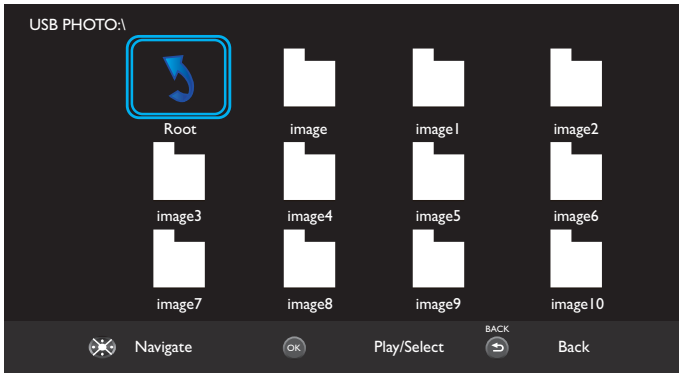

2 Press OK or ▶ to start a Slide show of the files.

- Press **OPTIONS** to display the optional menu, then use ◀▶ to select the desired item.

(Play) / (Pause)	Press OK or play/pause slideshow.
(Prev.) / ▶ (Next)	Go to the previous/next photo.
(Stop)	Stop slideshow.
(Info.)	Display photo information. (Resolution/Size/Date/Time)
(Zoom)	Change display size.(Full/2X/4X/8X)
(Rotate)	Press OK to rotate the picture.
(Repeat)	Select the repeat mode. (Repeat None/Repeat One/Repeat All)
(Music)	Play background music in slideshow mode. For this feature to work, the MP3 files have to be in the same folder as the currently playing pictures.

MUSIC

1 Use ▲▼◀▶ to select a file or a folder.

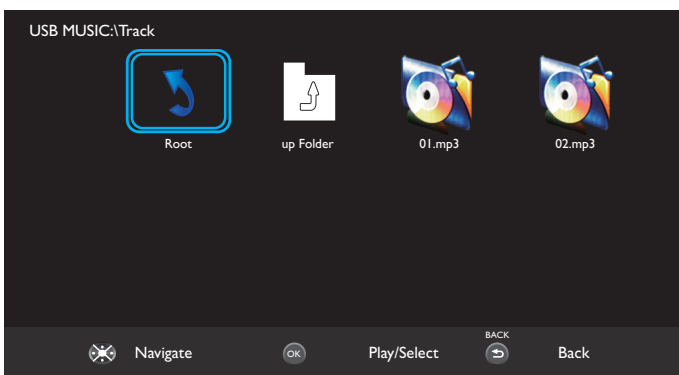

2 Press OK or ▶ to play the selected files.

- Press **OPTIONS** to display the optional menu, then use ◀▶ to select the desired item.

(Play) / (Pause)	Press OK or play/pause to play or pause the music.
(FB)	Press OK to Fast Backward the music. Repeatedly press OK to increase the speed: FBX2/FBX4/FBX8/FBX16/PLAY.
(FF)	Press OK to Fast Forward the music. Repeatedly press OK to increase the speed: FFX2/FFX4/FFX8/FFX16/PLAY.
(Prev.) / ▶ (Next)	Go to the previous/next track.
(Stop)	Stop music playback.
(Info.)	Display the information. (Album/Title/Bit Rate/Artist/Sampling/Year/Size)
(Repeat)	Select the repeat mode. (Repeat None/Repeat One/Repeat All)

MOVIE

1 Use ▲▼◀▶ to select a file or a folder.

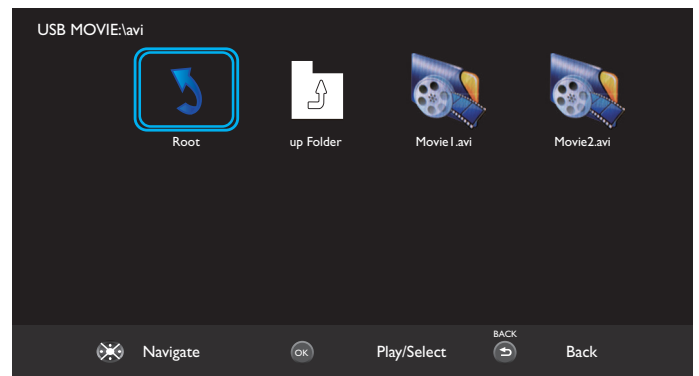

2 Press OK or ▶ to play the selected files.

- Press **OPTIONS** to display the optional menu, then use ◀▶ to select the desired item.

(Play) / (Pause)	Press OK or play/pause to play or pause the music.
(FB)	Press OK to Fast Backward the music. Repeatedly press OK to increase the speed: FBX2/FBX4/FBX8/FBX16/FBX32/Play.
(FF)	Press OK to Fast Forward the music. Repeatedly press OK to increase the speed: FFX2/FFX4/FFX8/FFX16/FFX32/Play.
(Prev.) / ▶ (Next)	Go to the previous/next track.
(Stop)	Stop music playback.
(Info.)	Display the information. (Resolution/Audio Track/Subtitle/Program/Size)
(Repeat)	Select the repeat mode. (Repeat None/Repeat One/Repeat All)
(Ratio)	Change display aspect ratio.(Auto/4:3/16:9)

Upgrading the software

USB upgrade

You can upgrade the software by using USB Memory Stick.

- 1 Connect your USB Memory Stick with the upgrade file to the USB terminal on the side of your TV.

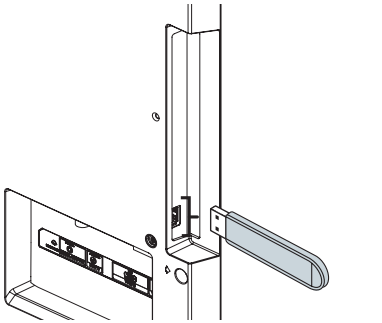

- 2 Press **HOME** (MENU) to display Home Menu and use **▲▼** to select **Features**, then press **OK**.
- 3 Use **▲▼** to select **Software upgrade**, then press **OK**.
- 4 Use **▲▼** to select **Upgrade**, then press **OK**.
- 5 Use **▲▼** to select **USB**.
- 6 Use **▲▼** to select **Check**, then press **OK**.
- 7 Read the on-screen instructions and confirm that you want to continue with the installation.

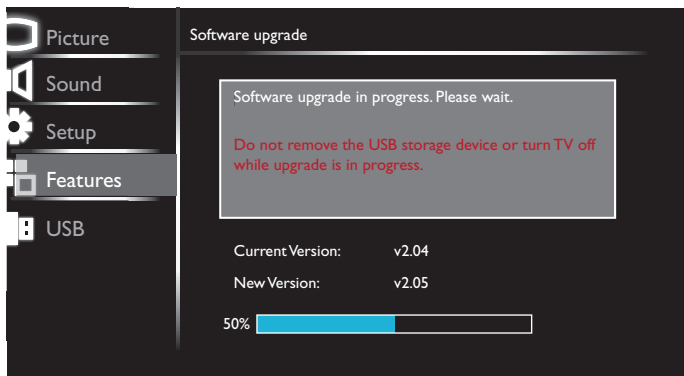

- 8 When the software upgrade is completed, remove the USB Memory Stick, then press **OK** to reboot the TV.
- 9 Unplug the AC power cord for a few seconds from AC outlet and plug it again.
- 10 Press **POWER** again to turn the unit On.
 - The TV starts up with the new software.
 - For further assistance, please contact Call Center.

Note

- All settings will remain the same even if you update the software version.

6 Connecting devices

No supplied cables are used with these connections:

- Please purchase the necessary cables at your local store.

Before you connect AC power cord:

Be sure other devices are connected properly before plugging in the AC power cord.

Selecting your connection quality

HDMI - Highest quality

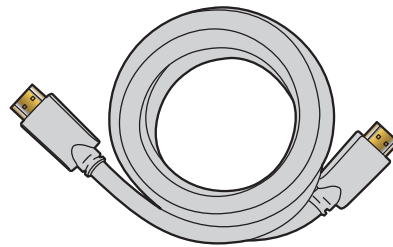

Supports high-definition Digital signals and gives highest picture and sound quality. Video and Audio signals are combined in one cable. You must use HDMI for full high-definition video and to enable Philips EasyLink.

Note

- Philips HDMI supports HDCP (High-bandwidth Digital Contents Protection). HDCP is a form of Digital Rights Management that protects high definition content in Blu-ray discs or DVDs.
- The HDMI-ARC connector on the TV features HDMI-ARC functionality. This allows output of TV Audio to an HDMI-ARC-compliant device.

Component (Y Pb Pr) - High quality

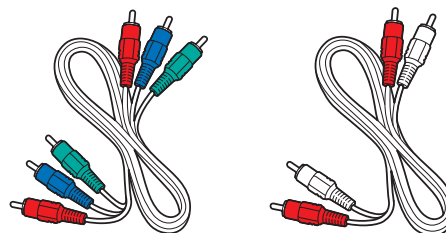

Supports high-definition Analog signals but gives lower picture quality than HDMI. Component (Y/Pb/Pr) Video cables combine Red / Green / Blue video cables with Red / White Audio (L/R) cables. Match the cable colors when you connect to the TV.

Composite - Basic quality

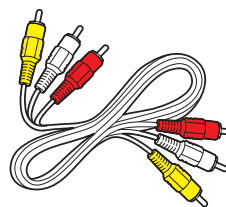

For Analog connections. Composite Video / Audio Analog cable usually combine a Yellow video cable with Red / White Audio (L/R) cables. With this unit, Yellow cable must be connected to Y (Green) of Component Video Input jacks.

Connecting your devices

HDMI Digital connection

HDMI connection offers the highest picture quality. HDMI (High-Definition Multimedia Interface) transports high definition Digital video and multi-channel Digital Audio through a single cable.

For 32PFL5708/F7 and 39PFL5708/F7

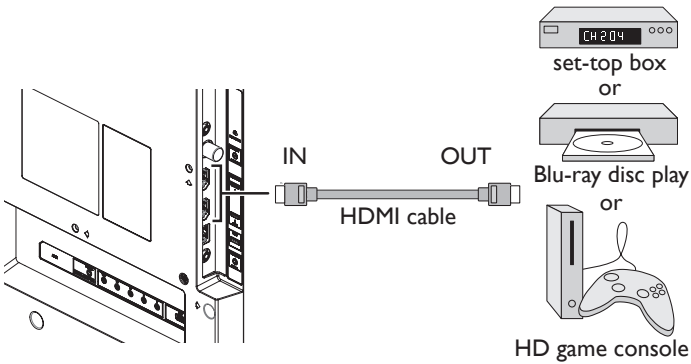

For 40PFL5708/F7, 47PFL5708/F7 and 50PFL5708/F7

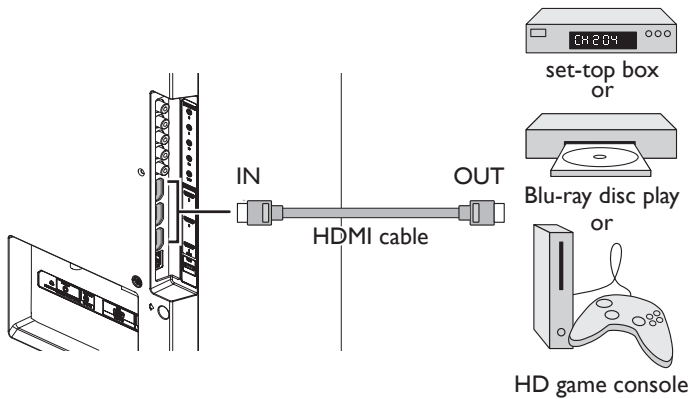

HDMI-DVI connection

This unit can be connected to your device that has a DVI terminal. Use an HDMI-DVI conversion cable for this connection and it requires Audio cable for Analog Audio signal as well.

For 32PFL5708/F7 and 39PFL5708/F7

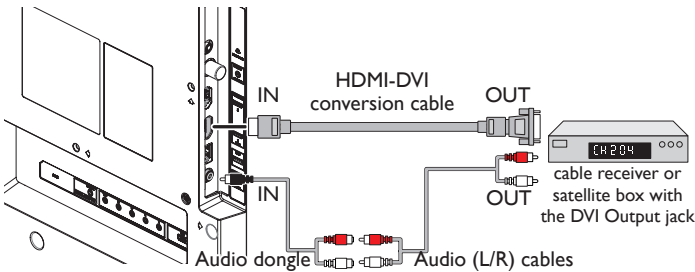

For 40PFL5708/F7, 47PFL5708/F7 and 50PFL5708/F7

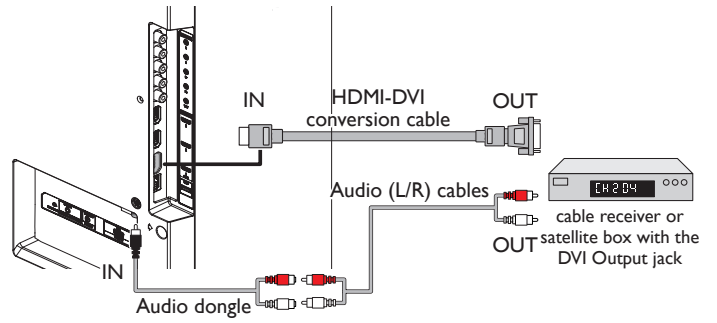

Note

- Use an HDMI cable with the HDMI logo (a certified HDMI cable). High Speed HDMI cable is recommended for the better compatibility.
- For HDMI connection**
 - The unit accepts 480i / 480p / 720p / 1080i, 1080p 24/30/60Hz of video signals, 32kHz / 44.1kHz and 48kHz of Audio signals.
 - This unit accepts 2 channel Audio signal (LPCM) only.
 - This unit accepts only signals in compliance with EIA861.
- For HDMI-DVI connection**
 - The unit accepts 480i, 480p, 720p, 1080i and 1080p video signals.
 - HDMI-DVI connection requires separate Audio connections as well and the Audio signals are output as Analog (L/R) Audio.
 - DVI does not display 480i image which is not in compliance with EIA/CEA-861/861B.

HDMI-ARC connection

HDMI-ARC allows you to use EasyLink to output TV Audio directly to a connected Audio device, without the need for an additional Digital Audio cable.

For 32PFL5708/F7 and 39PFL5708/F7

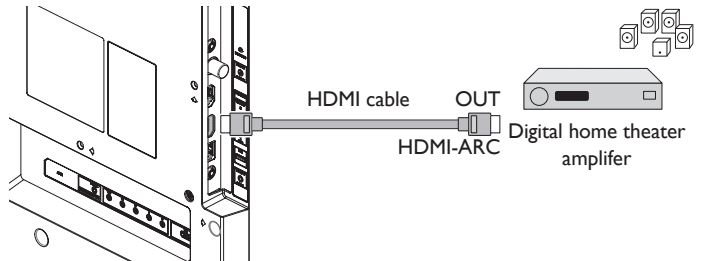

For 40PFL5708/F7, 47PFL5708/F7 and 50PFL5708/F7

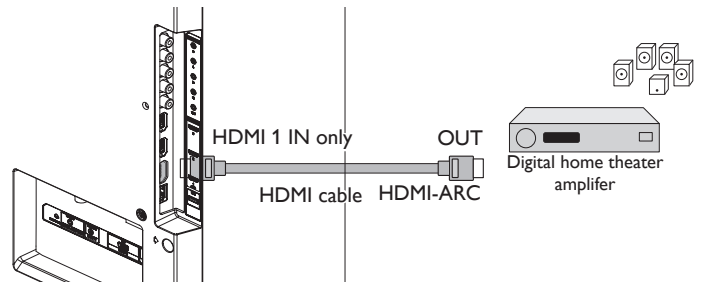

Note

- The HDMI 1 connector is HDMI Audio Return Channel (ARC) compliant. Use it to output Digital Audio to an HDMI home theater system.
- Be sure that the device is HDMI CEC and ARC compliant and that the TV is connected to the device using an HDMI cable attached to HDMI-ARC connectors.

Component Analog Video Connection

Component Analog Video connection offers better picture quality for video devices connected to the unit.

If you connect to the unit's Component Video (Y/Pb/Pr) Input jacks, connect Analog Audio cables to the Analog Audio (L/R) Input jacks.

For 32PFL5708/F7 and 39PFL5708/F7

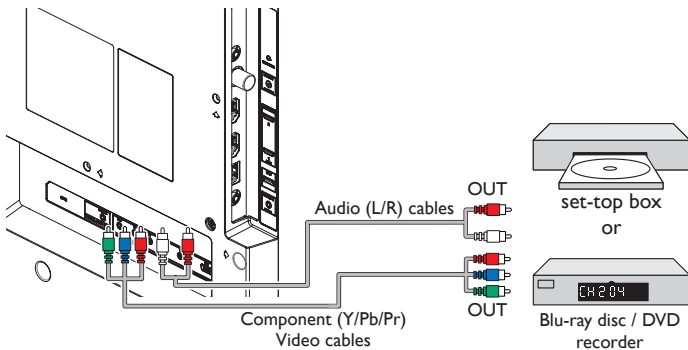

For 40PFL5708/F7, 47PFL5708/F7 and 50PFL5708/F7

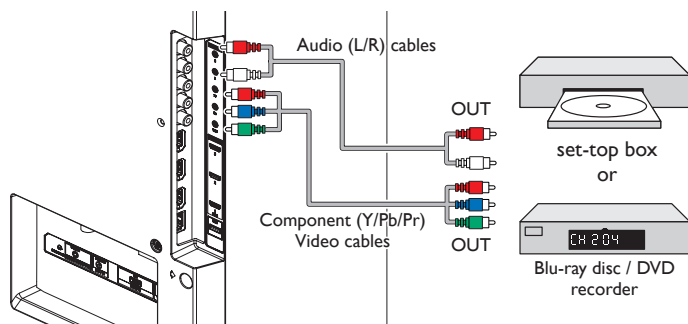

Note

- The unit accepts 480i / 480p / 720p and 1080i/p of video signals for this connection.

Digital Audio Output Connection

If you connect this unit to an external Digital Audio device, you can enjoy multi-channel Audio like 5.1ch Digital broadcasting sound.

Use a Digital Audio coaxial cable or Digital Audio optical cable to connect the unit to external Digital Audio devices.

For 32PFL5708/F7 and 39PFL5708/F7

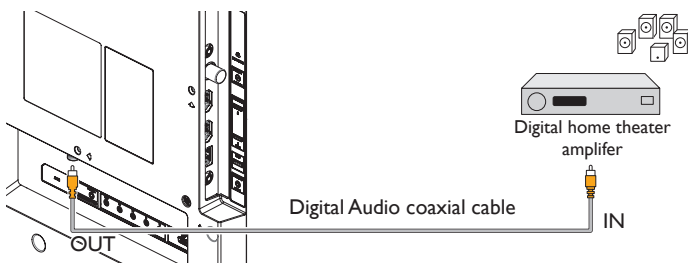

For 40PFL5708/F7, 47PFL5708/F7 and 50PFL5708/F7

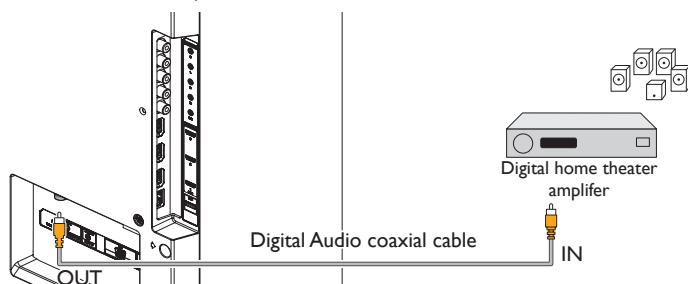

PC connection

HDMI connection

This unit can be connected to your PC that has a HDMI terminal. Use an HDMI cable for this Digital connection.

For 32PFL5708/F7 and 39PFL5708/F7

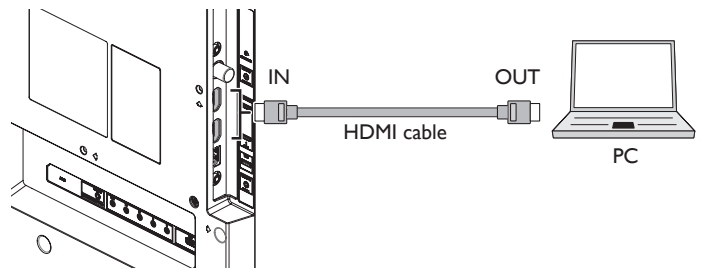

For 40PFL5708/F7, 47PFL5708/F7 and 50PFL5708/F7

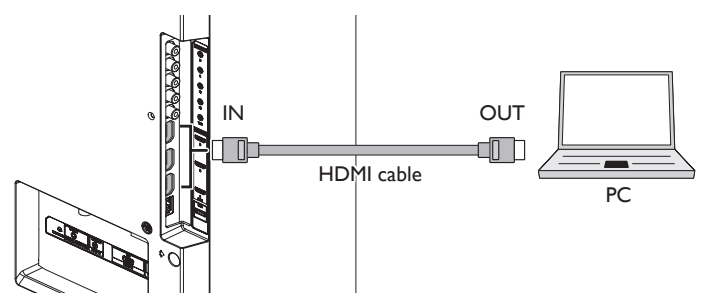

HDMI-DVI connection

This unit can be connected to your PC that has a DVI terminal. Use an HDMI-DVI conversion cable for this Video Digital connection and it requires Stereo mini 3.5mm plug Audio cable for Analog Audio signal as well.

For 32PFL5708/F7 and 39PFL5708/F7

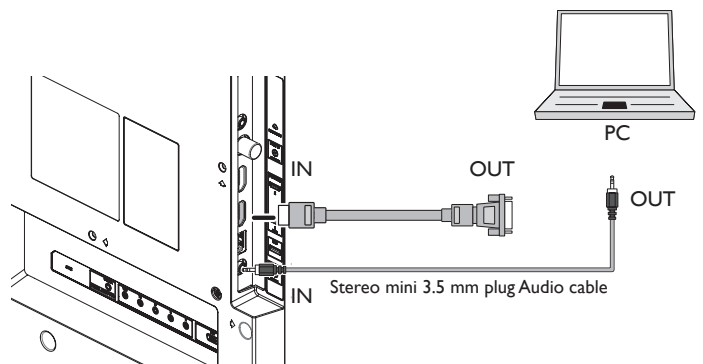

For 40PFL5708/F7, 47PFL5708/F7 and 50PFL5708/F7

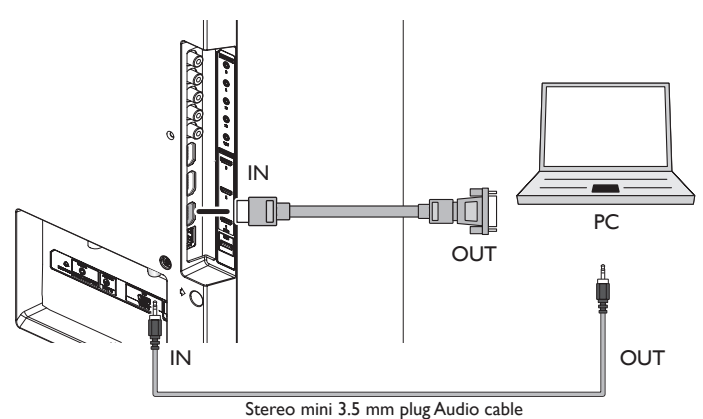

VGA connection

This unit is equipped with a PC Input jack. If you connect this unit to your PC, you can use this unit as a PC monitor.

Use a VGA cable for this Video connection and it requires a Stereo mini 3.5mm plug Audio cable for Analog Audio signal as well.

For 32PFL5708/F7 and 39PFL5708/F7

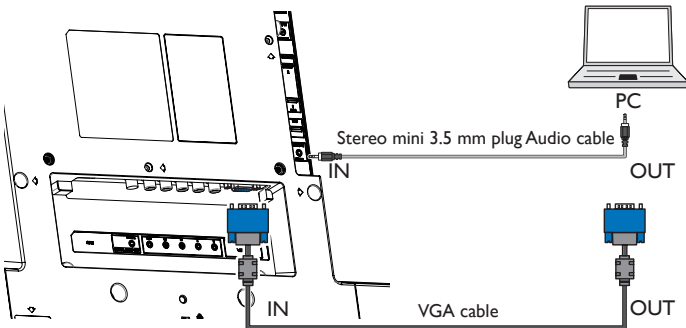

For 40PFL5708/F7, 47PFL5708/F7 and 50PFL5708/F7

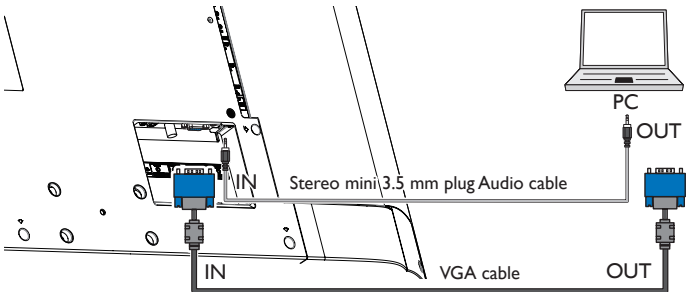

-The following video signals can be displayed:

Resolution	Refresh rate
640 × 480	60Hz
720 × 480	
800 × 600	
1024 × 768	
1280 × 768	
1280 × 1024	
1600 × 900	
1680 × 1050	
1920 × 1080	

Other formats or non-standard signals will not be displayed correctly.

Note

- Please purchase the VGA cable or HDMI-DVI conversion cable that has a ferrite core.
- The following operations may reduce noise.
 - Attach a ferrite core to the AC power cord of your PC.
 - Unplug the AC power cord and use the built-in battery of your PC.
- Use an HDMI cable with the HDMI logo (a certified HDMI cable). High Speed HDMI cable is recommended for the better compatibility.
- The unit accepts 480i, 480p, 720p, 1080i and 1080p video signals.
- HDMI-DVI connection requires separate Audio connections as well and the Audio signals are output as Analog (L/R) Audio.
- DVI does not display 480i image which is not in compliance with EIA/CEA-861/861B.

USB Memory Stick

This unit offers easy playback of picture, music and movie files.

Insert the USB Memory Stick into the USB terminal shown below.

USB  p. 27

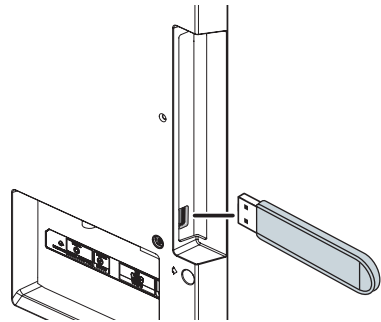

Note

- The unit recognizes only a USB Memory Stick.
- Do not use a USB hub or an extension cable to connect an external hard disk drive to the unit. (Not supported.)
- A USB Memory Stick is always inserted to this unit directly.
- A USB Memory Stick is not supplied with this unit.
- We do not guarantee that all USB Memory Sticks can be supported by this unit.
- Be sure to keep a backup copy of the original files on your device before you play them back on this unit. We have no responsibilities for damage or loss of your stored data.
- To protect your USB Memory Stick files from being erased place the write protect sliding tab in the protect position.
- When you are ready to remove a USB Memory Stick, set the unit to go into Standby mode to avoid any damage to your data and the unit.
- A USB Memory Stick that requires its own driver or the device with a special system such as fingerprint recognition are not supported.
- This unit is not allowed to use the USB Memory Stick which requires an external power supply (500mA or more).









7 Useful tips

FAQ

Question	Answer
<p>My remote control does not work.</p> <p>What should I do?</p>	<ul style="list-style-type: none"> • Check the antenna or cable connection to the main unit. • Check the batteries of the remote control. • Check if there is an obstacle between the infrared sensor window and the remote control. • Test the signal Output use IR Signal Check. ▶▶▶ p. 36 If okay, then possible infrared sensor trouble. • Aim the remote control directly at the infrared sensor window on the front of the unit. • Reduce the distance to the unit. • Re-insert the batteries with their polarities (+/-) as indicated. • When there is an infrared-equipped device such as PC near this unit, it may interrupt the remote control signal of this unit. Move the infrared-equipped device away from this unit, change the angle of the infrared sensor or Turn Off the infrared communication function.
<p>How come the initial setup appears every time I Turn On this unit?</p>	<ul style="list-style-type: none"> • Make sure to complete the initial setup before the unit goes into Standby mode.
<p>Why can I not watch some RF signal TV programs.</p>	<ul style="list-style-type: none"> • Autoprogram must be completed when you set up the unit for the first time or move it to a location where previously unavailable channels are broadcast. • Make sure Autoprogram has been completed. ▶▶▶ p. 21 • The selected channel may not be broadcasting. • When Autoprogram is interrupted and not completed, some channels will not be received. Make sure to complete the Autoprogram. ▶▶▶ p. 21 • The selected channel cannot be viewed by the Child lock setting. ▶▶▶ p. 23 • The unit requires some kind of antenna Input. An indoor antenna (Digital or VHF / UHF), an external antenna (Digital or VHF / UHF) or an RF coaxial cable from your wall cable/satellite box needs to be plugged into the unit.
<p>How come there is no image from the connected external devices?</p>	<ul style="list-style-type: none"> • Check if the correct Input mode is selected by pressing ↔ SOURCE. Watching channels from an external device ▶▶▶ p. 16 • Check the antenna, cable or other Input connection to the unit. • When using the Component Video Connection check that the Green (Y), Blue (Pb/Cb) and Red (Pr/Cr) connectors are connected to their corresponding colored jacks on the unit.
<p>When I enter a channel number, it changes automatically.</p>	<ul style="list-style-type: none"> • Many Digital channels have alternate channel numbers. The unit changes the numbers automatically to the ones signifying the broadcasting station channel number. These basic numbers used for previous Analog broadcasts. (e.g., Input ch# 30 automatically changes to ch# 6.1)
<p>Why are captions not displayed entirely? Or, captions are delayed behind the dialog.</p>	<ul style="list-style-type: none"> • Captions that are delayed a few seconds behind the actual dialog are common for live broadcasts. Most captioning production companies can display a dialog to maximum of 220 words per minute. If a dialog exceeds that rate, selective editing is used to insure that the captions remain up-to date with the current TV screen dialog.
<p>How can I set the clock ?</p>	<ul style="list-style-type: none"> • There is no clock function on this unit.
<p>I cannot change the Child lock setting because my PIN code no longer works.</p>	<ul style="list-style-type: none"> • Although the default PIN code (0000) is supplied with the unit, the PIN code will be required once you set a PIN code in Child lock. ▶▶▶ p. 23 When you forget your PIN code, enter 9999 in Change PIN to reset the PIN code. ▶▶▶ p. 25

Troubleshooting

If the unit does not perform properly when operated as instructed in this User Manual, **check the following chart and all connections once before calling for service.**

Symptom	Remedy
No power	<ul style="list-style-type: none"> • Make sure that the AC outlet supplies the proper voltage, plug another electrical appliance into the AC outlet to ensure that AC outlet operates normally. • If a power failure occurs, unplug the AC power cord for 1 minute to allow the unit to reset itself.
Remote control buttons do not work.	<ul style="list-style-type: none"> • Re-insert the batteries with their polarities (+/- signs) as indicated. • When there is an infrared-equipped device such as a PC is near this unit, it may interrupt the remote control signal of this unit.
Power is ON but no screen image.	<ul style="list-style-type: none"> • Check whether the connection of the antenna, cable receiver or satellite box is connected correctly. • Check whether all the cables to the unit are connected to the correct Output jack of your device like Blu-ray/DVD recorder. • Check if your computer is NOT in sleep mode when the Input mode of this unit is in PC mode. Tap any key on the keyboard to wake up your computer. • Check if the correct Input mode is selected by pressing  SOURCE.
No picture or sound	<ul style="list-style-type: none"> • View other TV channels. The problem might be limited to the broadcasting station or weak signal strength. • Unplug the AC power cord and wait for about 1 minute, then plug the AC power cord and turn On the unit again. • Autoprogram must be completed when you set up the unit for the first time or move it to a location where previously unavailable channels are broadcast. • The selected channel cannot be viewed by the Child lock setting.  p. 23 • The unit requires some kind of Input signal. An indoor antenna (VHF / UHF), an external antenna (VHF / UHF) or an RF coaxial cable from your wall or cable/satellite box signal needs to be plugged into the unit.
No color	<ul style="list-style-type: none"> • Adjust Color in Picture settings.  p. 18
No sound, distorted sound or incorrect Audio Sound is heard when using the HDMI-DVI connections.	<ul style="list-style-type: none"> • Make sure that the Analog Audio signals from the HDMI-DVI device are connected to the Analog Audio Input L/R jacks.
Adjusted Picture or Sound settings are not effective every time the unit is Turned On.	<ul style="list-style-type: none"> • You must set to Home in Location.  p. 26 Otherwise, the settings you adjusted will not be memorized after the unit goes into Standby mode.
Forgotten PIN code.	<ul style="list-style-type: none"> • Enter "9999" to clear your password.
Sound OK, picture poor	<ul style="list-style-type: none"> • Electrical interference from nearby appliances may affect picture quality. • Adjust Contrast and Brightness in Picture settings.  p. 18 • For the best picture quality, watch "High Definition" wide screen programs. If the HD content is not available, watch "Standard Definition" programs instead.
Picture OK, sound poor	<ul style="list-style-type: none"> • Check if the audio cable is connected in correctly. • No audio in USB Video playback, check if audio stream in video file is supported by TV by referring to table on.  p. 27
You see a distorted picture or hear an unusual sound.	<ul style="list-style-type: none"> • You may be getting NTSC TV signal (not HDTV signal) interference from electrical appliances, automobiles, motorcycles or fluorescent lights. • Try moving the unit to another location to see if this is the cause of the problem.
You see noise or trash on the screen.	<ul style="list-style-type: none"> • When the capabilities of the unit exceed the capabilities of the digital broadcasting, the signal will be increased to match the capabilities of the display of the unit. This may cause noise or trash.
You switch to a different Input and the volume changes.	<ul style="list-style-type: none"> • This unit will memorize the volume level from the last time you adjusted it. • If the volume of the sound from another device is higher or lower, then the loudness will change.
You switch to a different Input and the screen size changes.	<ul style="list-style-type: none"> • This unit will memorize the viewing mode from the last time you used the particular Input modes.
The display image does not cover the entire screen.	<ul style="list-style-type: none"> • If you are using the unit as a PC monitor, make sure that Horizontal position and Vertical position in PC settings are set correctly. • If you are watching TV or using the Composite Video, Component Video or HDMI with 480i Input, press  FORMAT repeatedly to switch various screen modes.
Captions are displayed as a white box. No caption is displayed in the closed caption-supported program.	<ul style="list-style-type: none"> • Interference from buildings or weather conditions may cause captioning to be incomplete. (for Analog only) • Broadcasting station may shorten the program to insert advertisement. The closed caption decoder cannot read the information of the shortened program. • Captions that are delayed a few seconds behind the actual dialog are common for live broadcasts. Most captioning production companies can display a dialog to maximum of 220 words per minute. If a dialog exceeds that rate, selective editing is used to insure that the captions remain up-to date with the current TV screen dialog.
Black box is displayed on the TV screen.	<ul style="list-style-type: none"> • The text mode is selected for caption. • Select CC-1, CC-2, CC-3 or CC-4.  p. 25

8 Information

Glossary

Analog TV (NTSC)

Acronym that stands for National Television Systems Committee and the name of Analog broadcasting standards.

Off-the-air NTSC signals are no longer being sent by major broadcasting stations in the USA.

ARC (Audio Return Channel) (HDMI 1 only)

HDMI-ARC allows you to use Philips EasyLink to output TV audio directly to a connected Audio device, without the need for an additional Digital Audio cable. Be sure that the device is HDMI CEC and ARC compliant, and that the TV is connected to the device using an HDMI cable attached to both HDMI-ARC connectors.

Aspect ratio

The width of a TV screen relative to its height. Conventional TVs are 4:3 (in other words, the TV screen is almost square); widescreen models are 16:9 (the TV screen is almost twice as wide as its height).

CEC (Consumer Electronics Control)

This allows you to operate the linked functions between our brand devices with CEC feature and this unit. We do not guarantee 100% interoperability with other brands of CEC compliant devices.

Component Video

This is a video signal format that conveys each of 3 principal colors of light (red, blue and green) through different signal lines. This allows the viewers to experience picture colors as original as it is. There are several signal formats, including Y / Pb / Pr and Y / Cb / Cr.

Dolby Digital

The system developed by Dolby Laboratories to compress Digital sound. It offers stereo sound (2ch) or multi-channel Audio.

DTV (ATSC)

Acronym that stands for Advanced Television Systems Committee and the name of the Digital broadcasting standards.

E-sticker

E-sticker is showing set features, technical information, etc on this TV set that is displayed on the TV screen mainly used by TV retailers. Previously the information was on a printed sticker that was put on the display.

HDMI (High-Definition Multimedia Interface)

Interface that supports all uncompressed, Digital Audio / Video formats including set-top box, Blu-ray / DVD recorder or Digital television, over a single cable.

HDTV (High Definition TV)

Ultimate Digital format that produces high resolution and high picture quality.

PIN code

A stored 4-digit number that allows access to parental control features.

SAP (Secondary Audio Program)

Second-Audio channel delivered separately from main-Audio channel. This Audio channel is used as an alternate in bilingual broadcasting.

SDTV (Standard Definition TV)

Standard Digital format that is similar to the Analog TV (NTSC) picture quality.

DTS TruSurround

Enable DTS TruSurround to enhance your audio experience.

Maintenance

Cabinet Cleaning

- Wipe the front panel and other exterior surfaces of the unit with a soft cloth.
- Never use a solvent or alcohol. Do not spray insecticide liquid near the unit. Such chemicals may cause damage and discoloration to the exposed surfaces.

Panel Cleaning

Wipe the panel of the unit with a soft cloth. Before cleaning the panel, disconnect the AC power cord.

Servicing

Should your unit become inoperative, do not try to correct the problem yourself. There are no user serviceable parts inside. Call our toll free customer support line found on the cover of this User Manual to locate an authorized service center.

IR Signal Check

If the remote control is not working properly, you can use a Digital camera (including a cellular phone with built-in camera) to see if it is sending out an infrared signal.



With a Digital camera
(including built-in cell phone cameras):

Point the Digital Camera towards the remote control infrared diode at the front of the remote control. Press any button on the remote control and look through the camera display. If the infrared pulsating light appears through the camera, the remote control is sending out an IR signal.

9 Specifications

Model #	32PFL5708/F7 39PFL5708/F7 40PFL5708/F7 47PFL5708/F7 50PFL5708/F7
Picture enhancement	
Type	FHD (1920 x 1080 pixels 60Hz)
Aspect ratio	4:3/ 16:9
Viewing angles	178° (V) by 178° (H)
Built-in Digital tuner	ATSC / NTSC
Sound enhancement	
Mono / Stereo	Mono, Stereo, DTS TruSurround
Power output (RMS watts)	5 W x 2 (32PFL5708/F7, 39PFL5708/F7 and 40PFL5708/F7); 8 W x 2 (47PFL5708/F7, 50PFL5708/F7)
Equalizer	5 band
Ease of use	
Picture format	SD (4:3 Source) : Normal / Zoom / Wide / Cinema / Auto HD (16:9 Source) : Normal / Zoom / Wide / Cinema / Auto HDMI AV (4:3 Source) : Normal / Zoom / Wide / Cinema / Auto HDMI AV (16:9 Source) : Normal / Zoom / Wide / Cinema / Auto PC Source : (Refer to HDMI AV (16:9 Source) above if PC has HDMI Output.)
Photo Slide show	JPEG files only
Video playback	MPEG1(.dat/.mpg/.mpeg/.mkv), MPEG2(.dat/.mpg/.mpeg/.avi), MPEG2-PS(.vob/), MPEG2-TS(.ts/.trp/.tp/.m2ts), H.264(.ts/.trp/.tp/.m2ts/.mp4/.mkv/.avi), MPEG4 SP/ASP(.avi), MPEG4(.mp4/.avi), MP4(.mp4), JPEG(Motion JPEG)
Music	MPEG1 Layer 2: 32Kbps ~ 448Kbps(Bit rate) 32KHz ~ 48KHz(Sampling rate) MPEG1 Layer 3: 32Kbps ~ 320Kbps(Bit rate) 32KHz ~ 48KHz(Sampling rate) MPEG2 Layer3: 32Kbps ~ 320Kbps(Bit rate) 32KHz ~ 48KHz(Sampling rate)
Connections	
Component Video Input (Y/Pb/Pr)	1 supporting video signals : 480i/p, 720p, 1080i/p 60Hz
Component Audio L/R Input	1
Composite Video / Audio Input	1 shared with ComponentY and L/R
HDMI Input	32PFL5708/F7 , 39PFL5708/F7 x2 40PFL5708/F7 , 47PFL5708/F7, 50PFL5708/F7 x3
PC Input	via VGA, HDMI and HDMI-DVI + PC Audio
USB	1
Digital Audio Output	1 supporting Dolby Digital
Headphone Output	1 1/8 inches (3.5mm)
Power	
Power requirements	120V~ AC +/- 10%, 60Hz +/- 0.5%
Temperature	
Operating temperature	41 °F (5 °C) to 104 °F (40 °C)

- Specifications are subject to change without prior notice.

10 Warranty

LIMITED WARRANTY ONE (1) YEAR

WARRANTY COVERAGE:

This warranty obligation is limited to the terms as set forth below.

WHO IS COVERED:

This product warranty is issued to the original purchaser or the person receiving the product as a gift against defects in materials and workmanship as based on the date of original purchase ("Warranty Period") from an Authorized Dealer. The original sales receipt showing the product name and the purchase date from an authorized retailer is considered such proof.

WHAT IS COVERED:

This warranty covers new products if a defect in material or workmanship occurs and a valid claim is received within the Warranty Period. At its option, the company will either (1) repair the product at no charge, using new or refurbished replacement parts, or (2) exchange the product with a product that is new or which has been manufactured from new, or serviceable used parts and is at least functionally equivalent or most comparable to the original product in current inventory, or (3) refund the original purchase price of the product.

Replacement products or parts provided under this warranty are covered against defects in materials and workmanship from the date of the replacement or repair for ninety (90) days or for the remaining portion of the original product's warranty, whichever provides longer coverage for you. When a product or part is exchanged, any replacement item becomes your property and the replaced item becomes company property. When a refund is given, your product becomes company property.

Note: Any product sold and identified as refurbished or renewed carries a ninety (90) day limited warranty.

Replacement product can only be sent if all warranty requirements are met. Failure to follow all requirements can result in delay.

WHAT IS NOT COVERED - EXCLUSIONS AND LIMITATIONS:

This Limited Warranty applies only to new company manufactured products that can be identified by the trademark, trade name, or logo affixed to it. This Limited Warranty does not apply to any hardware product or any software, even if packaged or sold with the product, as manufacturers, suppliers, or publishers may provide a separate warranty for their own products packaged with the bundled product.

The company is not liable for any damage to or loss of any programs, data, or other information stored on any media contained within the product, or other additional product or part not covered by this warranty. Recovery or reinstallation of programs, data or other information is not covered under this Limited Warranty.

This warranty does not apply (a) to damage caused by accident, abuse, misuse, neglect, misapplication, or non-supplied product, (b) to damage caused by service performed by anyone other than company approved Authorized Service Location, (c) to a product or a part that has been modified without written company permission, or (d) if any serial number has been removed or defaced, or (e) product, accessories or consumables sold "AS IS" without warranty of any kind by including refurbished product sold "AS IS" by some retailers.

This Limited Warranty does not cover:

- Shipping charges to return defective product approved Authorized Service Location, (c) to a product or a part that has been modified without written company permission, or (d) if any serial number has been removed or defaced, or (e) product, accessories or consumables sold "AS IS" without warranty of any kind by including refurbished product sold "AS IS" by some retailers.

This Limited Warranty does not cover:

- Shipping charges to return defective product..
- Labor charges for installation or setup of the product, adjustment of customer controls on the product, and installation or repair of antenna/ signal source systems outside of the product.
- Product repair and/or part replacement because of improper installation or maintenance, connections to improper voltage supply, power line surge, lightning damage, retained images or screen markings resulting from viewing fixed stationary content for extended periods, product cosmetic appearance items due to normal wear and tear, unauthorized repair or other cause not within the control of the company.
- Damage or claims for products not being available for use, or for lost data or lost software.
- Damage from mishandled shipments or transit accidents when returning product.
- A product that requires modification or adaptation to enable it to operate in any country other than the country for which it was designed, manufactured, approved and/or authorized, or repair of products damaged by these modifications.
- A product used for commercial or institutional purposes (including but not limited to rental purposes).
- Product lost in shipment and no signature verification receipt can be provided.
- Failure to operate per Owner's Manual.

TO OBTAIN ASSISTANCE...

Contact the Customer Care Center at:

1 866 309 5962

REPAIR OR REPLACEMENT AS PROVIDED UNDER THIS WARRANTY IS THE EXCLUSIVE REMEDY FOR THE CONSUMER, WITH THE ISSUING COMPANY NOT LIABLE FOR ANY INCIDENTAL OR CONSEQUENTIAL DAMAGES FOR BREACH OF ANY EXPRESS OR IMPLIED WARRANTY ON THIS PRODUCT. EXCEPT TO THE EXTENT PROHIBITED BY APPLICABLE LAW, ANY IMPLIED WARRANTY OF MERCHANTABILITY OR FITNESS FOR A PARTICULAR PURPOSE ON THIS PRODUCT IS LIMITED IN DURATION TO THE DURATION OF THIS WARRANTY.

Some states do not allow the exclusions or limitation of incidental or consequential damages, or allow limitations on how long an implied warranty lasts, so the above limitations or exclusions may not apply to you.

This warranty gives you specific legal rights. You may have other rights which vary from state/province to state/province.

P&F USA, Inc. PO Box 2248, Alpharetta, GA 30023-2248



P&F USA, Inc.
PO Box 2248, Alpharetta, GA 30023-2248

P&F Mexicana, S.A. de C.V.
Av. La Palma No. 6, Col. San Fernando La Herradura,
Huixquilucan, Edo. de México. C.P. 52787