



HT I075/HT I085ST
Digital Projector
Home Cinema Series
User Manual

Table of contents

Important safety instructions.....	3	About the OSD Menus.....	29
Overview.....	6	Using the Basic OSD menu.....	31
Projector features	6	Basic OSD menu - with input signals	
Shipping contents.....	8	connected.....	31
Standard accessories.....	8	Basic OSD menu - without input signals	
Projector exterior view	9	connected.....	34
Controls and functions.....	10	Using the Advanced OSD menu.....	35
Control panel	10	Picture menu.....	36
Remote control.....	11	Audio Setup menu.....	40
Installation	13	Display menu.....	41
Choosing a location	13	System Setup : Basic menu.....	43
Obtaining a preferred projected image		System Setup : Advanced menu.....	44
size	14	Information menu.....	46
Projection dimensions	14	Advanced OSD menu structure	47
Shifting the projection lens vertically		Maintenance	49
(HT1075 only)	15	Care of the projector	49
Connection	16	Lamp information.....	50
Connecting with video equipment	17	Getting to know the lamp hour.....	50
Connecting HDMI devices.....	17	Extending lamp life	50
Connecting smart devices	18	Timing of replacing the lamp	51
Connecting component-video devices ...	19	Replacing the lamp	52
Connecting video devices	19	Indicators	54
Connecting a computer	20	Troubleshooting.....	55
Operation.....	21	Specifications.....	56
Starting up the projector	21	Projector specifications.....	56
Shutting down the projector	22	Dimensions	57
Securing the projector	23	Ceiling mount installation.....	57
Using a security cable lock	23	Timing chart.....	58
Utilizing the password function.....	23	Warranty and Copyright	
Selecting an input source.....	26	information	63
Renaming an input source	26	Warranty	63
Adjusting the projected image.....	27	Copyright.....	63
Adjusting the projection angle.....	27	Disclaimer	63
Auto-adjusting the image	27		
Fine-tuning the image size and clarity	27		
Correcting keystone.....	28		
Menu Functions.....	29		

Important safety instructions

Your projector is designed and tested to meet the latest standards for safety of information technology equipment. However, to ensure safe use of this product, it is important that you follow the instructions mentioned in this manual and marked on the product.

1. Please read this user manual before you operate your projector. Keep this manual in a safe place for future reference.

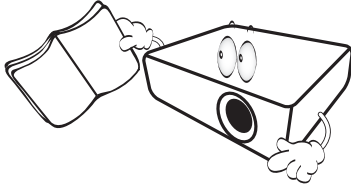

2. Always place the projector on a level, horizontal surface during operation.

- Do not place the projector on an unstable cart, stand, or table as it may fall and be damaged.
- Do not place inflammables near the projector.
- Do not use if tilted at an angle of more than 10 degrees left to right, nor at angle of more than 15 degrees front to back.

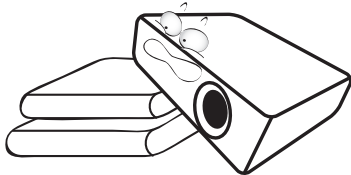

3. Do not store the projector on end vertically. Doing so may cause the projector to fall over, causing injury or resulting in damage.

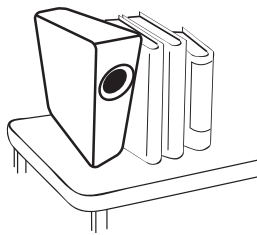

4. Do not place the projector in any of the following environments:

- Space that is poorly ventilated or confined. Allow at least 50 cm clearance from walls and free flow of air around the projector.
- Locations where temperatures may become excessively high, such as the inside of a car with all windows closed.
- Locations where excessive humidity, dust, or cigarette smoke may contaminate optical components, shorten the projector's lifespan and darken the screen.

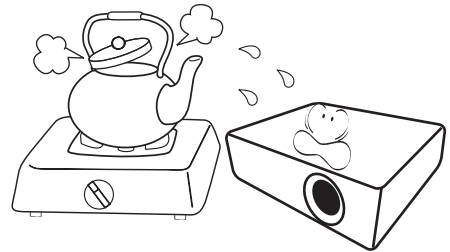

- Locations near fire alarms.
- Locations with an ambient temperature above 35°C/95°F.
- Locations where the altitudes are higher than 3000 m (10000 feet).

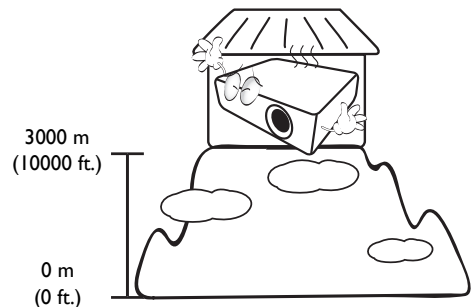

5. Do not block the vents holes while the projector is on (even in standby mode).

- Do not cover the projector with any item.
- Do not place the projector on a blanket, bedding or any other soft surface.

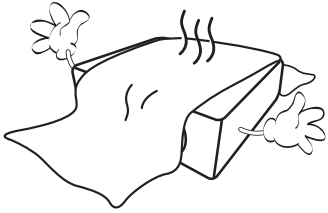

9. Do not look straight into the projector lens during operation. It may harm your sight.

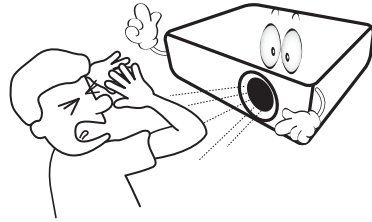

6. In areas where the mains power supply voltage may fluctuate by ± 10 volts, it is recommended that you connect the projector through a power stabilizer, surge protector or uninterruptible power supply (UPS) as appropriate to your situation.

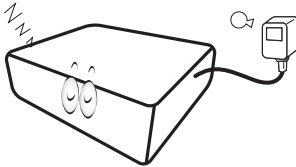

10. Do not operate the projector lamp beyond the rated lamp life. Excessive operation of lamps beyond the rated life could cause a lamp to break on rare occasions.

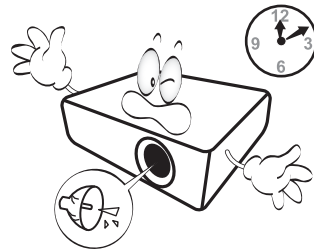

7. Do not step on the projector or place any objects upon it.

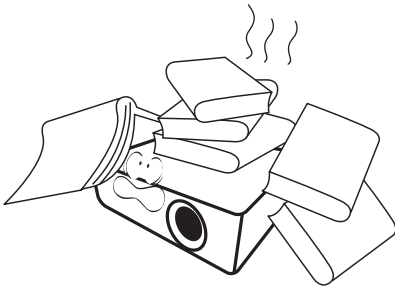

11. The lamp becomes extremely hot during operation. Allow the projector to cool for approximately 45 minutes prior to removing the lamp assembly for replacement.

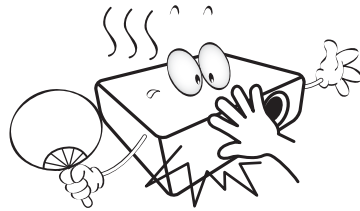

8. Do not place liquids near or on the projector. Liquids spilled into the projector will void your warranty. If the projector does become wet, disconnect it from the power point and call BenQ to have the projector repaired.

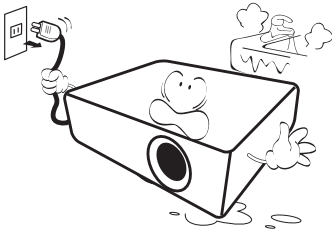

12. Never attempt to replace the lamp assembly until the projector has cooled down and is unplugged from the power supply.

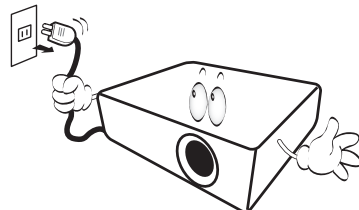

13. This projector is capable of displaying inverted images for ceiling mount installation. Use only BenQ's Ceiling Mount Kit for mounting.

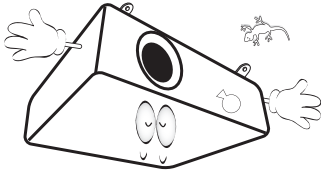

15. When you think service or repair is required, take the projector only to a suitably qualified technician.

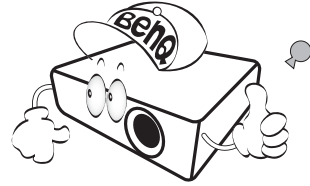

⚠ Ceiling mounting the projector

If you intend to mount your projector on the ceiling, we strongly recommend that you use a proper fitting BenQ projector ceiling mount kit and ensure it is securely and safely installed.

If you use a non-BenQ brand projector ceiling mount kit, there is a safety risk that the projector may fall from the ceiling due to an improper attachment through the use of the wrong gauge or length screws.

You can purchase a BenQ projector ceiling mount kit from the place you purchased your BenQ projector. BenQ recommends that you also purchase a separate Kensington lock compatible security cable and attach it securely to both the Kensington lock slot on the projector and the base of the ceiling mount bracket. This will perform the secondary role of restraining the projector should its attachment to the mounting bracket become loose.

14. Do not attempt to disassemble this projector. There are dangerous high voltages inside which may cause death if you should come into contact with live parts. The only user serviceable part is the lamp. See page 52.
- Under no circumstances should you ever undo or remove any other covers. Refer servicing only to suitably qualified professional service personnel.

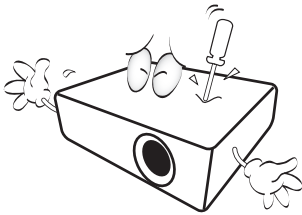

- ⚠ **Please keep the original packing for possible future shipment. If you need to pack your projector after use, adjust the projection lens to an appropriate position, put the lens cushion around the lens, and fit the lens cushion and projector cushion together to prevent damage during transportation.**

Moisture condensation

Never operate the projector immediately after moving it from a cold location to a hot location. When the projector is exposed to such a change in temperature, moisture may condense on the crucial internal parts. To prevent the projector from possible damage, do not use the projector for at least 2 hours when there is a sudden change in temperature.

Avoid volatile liquids

Do not use volatile liquids, such as insecticide or certain types of cleaner, near the projector. Do not have rubber or plastic products touching the projector for a long time. They will leave marks on the finish. If cleaning with a chemically treated cloth, be sure to follow the cleaning product's safety instructions.

Disposal

This product contains the following materials which are harmful to human bodies and environment.

- Lead, which is contained in solder.
- Mercury, which is used in the lamp.

To dispose of the product or used lamps, consult your local environment authorities for regulations.

Overview

Projector features

- **Full HD compatible**
The projector is compatible with Standard Definition TV (SDTV) 480i, 576i, Enhanced Definition television (EDTV) 480p, 576p and High Definition TV (HDTV) 720p, 1080i/p 60Hz formats, with the 1080p format providing a true 1:1 image reproduction.
- **High picture quality**
The projector provides excellent picture quality due to its high resolution, excellent home theater brightness, high contrast ratio, vivid color and rich gray-scale reproduction.
- **High brightness**
The projector features super high brightness to achieve excellent picture quality in ambient light conditions, outperforming ordinary projectors.
- **Vivid color reproduction**
The projector features a 6-segment color wheel to produce realistic color depth and range unattainable with lesser segment color wheels.
- **Rich gray-scale**
When viewed in a darkened environment, the automatic gamma control provides excellent gray-scale display which reveals details in shadows and in night or darkened scenes.
- **2D Keystone**
The projector offers horizontal (side to side) keystone correction, enabling a wider projector installation area. When the projector is placed off center, the 2D keystone correction feature gives you a wider projector installation flexibility by correcting the trapezoid effect using horizontal and vertical adjustments.
- **Dual OSD**
Two types of OSD menus are designed for different usage customs: the **Basic** OSD is intuitive and consumerlike, while the **Advanced** OSD offers traditional usability.
- **Wide variety of inputs and video formats**
The projector supports a wide variety of inputs for connection to your video, computer, and smart equipment, including component video, composite video, personal computer (both Mac and PC), HDMI source, smart device that supports MHL, and an output trigger for connection to automated screen and environment lighting systems.
- **ISF certified calibration control**
To reach a higher standard of performance, the projector incorporates ISF NIGHT and ISF DAY mode settings in its OSD menus, which requires professional calibration service from authorized ISF installers.
- **3D function**
To enjoy the 3D movies, videos, and sporting events in a more realistic way by presenting the depth of the images through HDMI.
- **Built-in chamber speaker(s)**
Built-in speaker(s) providing mixed mono audio when an audio input is connected.

- **Intuitive lens shift (HT1075)**
The intuitive control over lens shift lever provides flexibility in setting-up your projector.
- **Short throw ratio (HT1085ST)**
The short throw ratio projection provides 1080p picture quality with shorter projection distance.
- **SmartEco**
SmartEco™ technology saves lamp power consumption up to 70% depending on the content brightness level when **SmartEco** mode is selected.
- **Wireless FHD Kit supported (optional accessory)**
Refer to the kit's documentation to learn how to use it.

Shipping contents

Carefully unpack and verify that you have the items below. Some of the items may not be available depending on your region of purchase. Please check with your place of purchase.

Standard accessories

 Some of the accessories may vary from region to region.

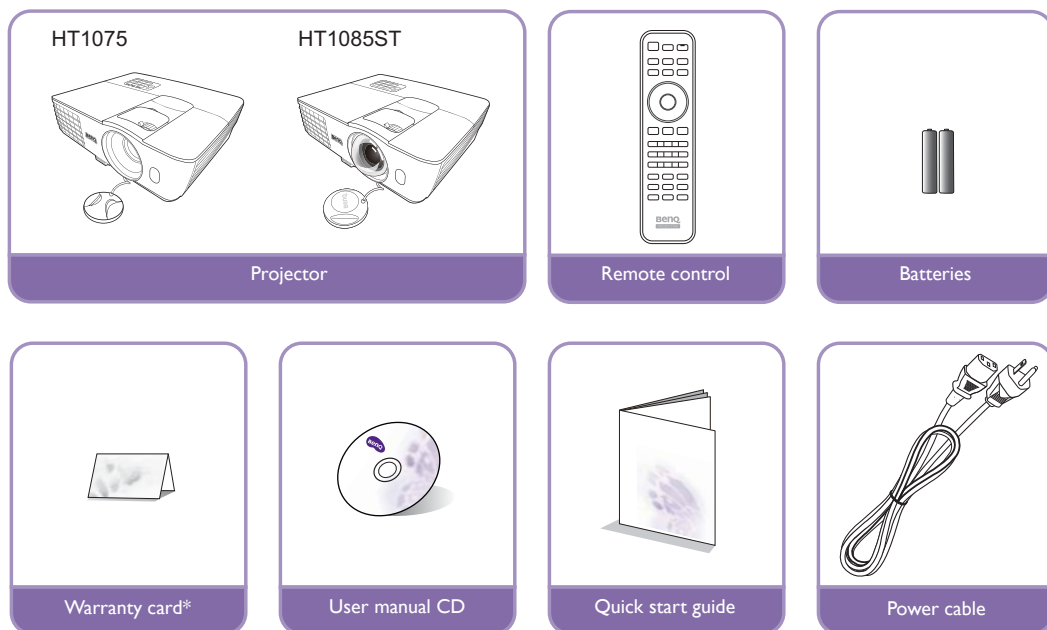

* The warranty card is only supplied in some specific regions. Please consult your dealer for detailed information.

Optional accessories

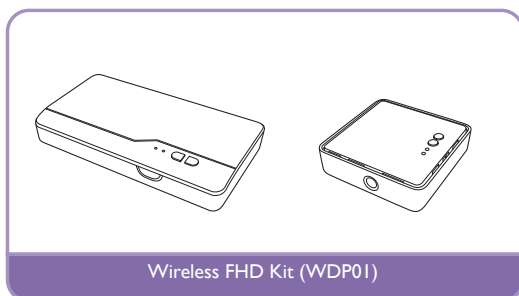

Projector exterior view

Front and upper side view

HT1075

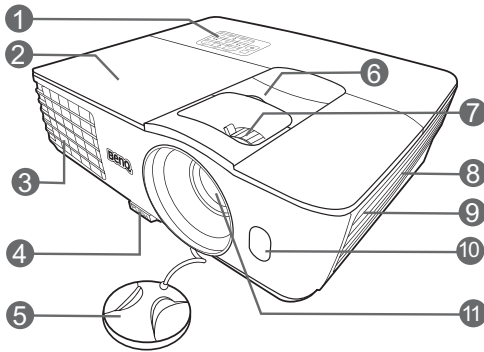

HT1085ST

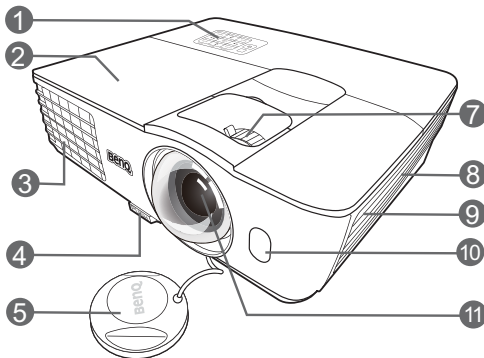

1. Control panel (See [Control panel](#) for details.)
2. Lamp cover
3. Vent (heated air exhaust)
4. Quick-release button
5. Lens cap
6. Lens shift lever
7. Focus and Zoom ring
8. Vent (cool air intake)
9. Speaker grill
10. Front IR sensor
11. Projection lens
12. HDMI input port
13. MHL/HDMI dual mode port
Also can be used for charging the connected MHL compatible smart device as long as the power is fed to the projector.
14. 12VDC output terminal
Used to trigger external devices such as an electric screen or light control, etc. Consult your dealer for how to connect these devices.
15. USB Type-A port
Used for charging the receiver box of the Wireless FHD Kit (WDP01) (optional accessory).
16. Mini USB port
Used for service.
17. RGB (PC)/Component video (YPbPr/YCbCr) signal input jack
18. RS-232 control port
Used to interface with a PC or home theater control/automation system.
19. Component Video inputs (RCA) support Y/Pb/Pr or Y/Cb/Cr video signal
20. Video input jack
21. Audio (L/R) input jacks
22. Audio input jack
23. Audio output jack
24. AC Power cable inlet
25. Rear adjuster foot
26. Ceiling mount holes
27. Wireless FHD Kit mount holes
28. Kensington lock slot

Rear and lower side view

See [Connecting with video equipment](#) for connection details.

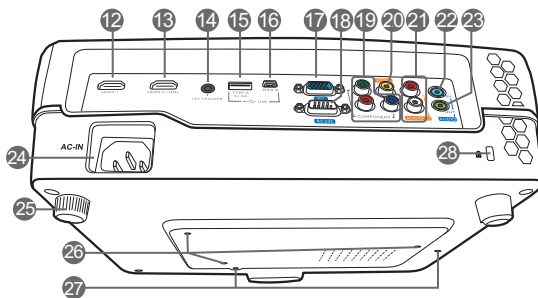

Controls and functions

Control panel

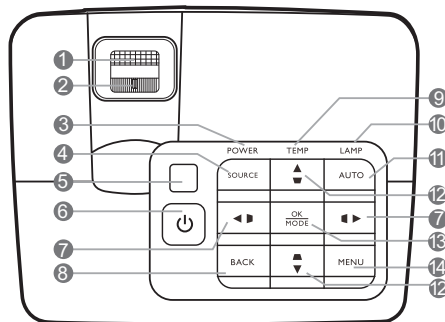

1. Focus ring

Adjusts the focus of the projected image.

2. Zoom ring

Adjusts the size of the image.

3. POWER indicator light

Lights up or flashes when the projector is under operation.

4. SOURCE

Displays the source selection bar.

5. Top IR remote sensor

6. POWER

Toggles the projector between standby mode and on.

7. Keystone/Arrow keys (◀ / ▢, ▣ / ▶)

Manually corrects distorted images resulting from an angled projection.

When the On-Screen Display (OSD) menu is activated, the #7 and #12 keys are used as directional arrows to select the desired menu items and to make adjustments.

8. BACK

Goes back to previous OSD menu, exits and saves menu settings.

9. TEMPerature warning light

Lights up red if the projector's temperature becomes too high.

10. LAMP indicator light

Indicates the status of the lamp. Lights up or flashes when the lamp has developed a problem.

11. AUTO

Automatically determines the best picture timings for the displayed image.

12. Keystone/Arrow keys (▲ / ▽, ▹ / ▸)

Manually corrects distorted images resulting from an angled projection.

When the On-Screen Display (OSD) menu is activated, the #7 and #12 keys are used as directional arrows to select the desired menu items and to make adjustments.

13. OK/MODE

- Selects an available picture mode.
- Confirms the selected On-Screen Display (OSD) menu item.

14. MENU

- Accesses the On-Screen Display (OSD) menu.
- Goes back to previous OSD menu, exits and saves menu settings.

Remote control

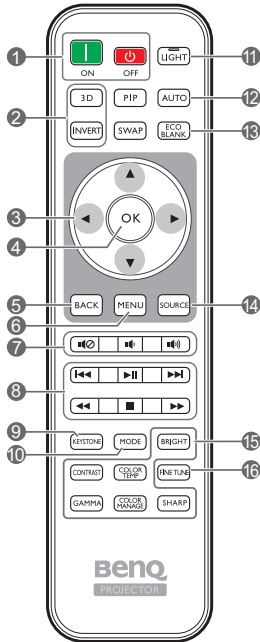

1. **ON, OFF**

Toggles the projector between on and off mode.

2. **3D, INVERT**

Launches the **3D** menu and toggles the invert function between on and off.

3. **Arrow keys (◀ Left, ▶ Right, ▲ Up, ▼ Down)**

When the On-Screen Display (OSD) menu is activated, these keys are used as directional arrows to select the desired menu items and to make adjustments.

When the OSD menu is off and you are under the MHL connection mode, these arrows keys are available for controlling your smart device.

4. **OK**

Confirms the selected OSD menu item.

When the OSD menu is off and you are under the MHL connection mode, use the key to confirm the selection on the OSD of your smart device.

5. **BACK**

Goes back to previous OSD menu, exits and saves menu settings.

When the OSD menu is off and you are under the MHL connection mode, use the key to return or exit the OSD menu of your smart device.

6. **MENU**

- Accesses the On-Screen Display (OSD) menu.
- Goes back to previous OSD menu, exits and saves menu settings.

7. **Mute, Volume Down, Volume Up**

- **Mute:** Toggles projector audio between on and off.
- **Volume Down:** Decreases the projector volume.
- **Volume Up:** Increases the projector volume.

8. **MHL control buttons**

(◀◀ Backward, ▶▶ Play/Pause, ▶▶▶ Forward, ◀◀◀ Rewind, ■ Stop, ▶▶▶ Fast forward)

Goes to the previous file/Plays/Pauses/Goes to the next file/Rewinds/Stops/Fast-forwards during media playback. Only available when controlling your smart device in MHL mode.

☞ **When you are under the MHL connection mode and the OSD is off, these buttons are available for controlling your smart device: arrow keys, OK, BACK, and MHL control buttons.**

9. **KEYSTONE**

Launches the **2D Keystone** window. Use the **Arrow keys** to manually correct distorted images resulting from an angled projection.

10. **MODE**

Selects an available picture mode.

11. **LIGHT**

The LED backlight lights up and stays on for approximately 30 seconds when pressing any key on the remote control. Pressing any other keys within the 10 second again turns the LED backlight off.

12. **AUTO**

Automatically determines the best picture timings for the displayed image.

13. **ECO BLANK**

Used to blank the screen picture.

14. **SOURCE**

Displays the source selection bar.

15. **Picture quality adjustment keys**

These function keys perform the same tasks as specified in the OSD menu.

16. **FINE TUNE**

Displays the **Color Temperature Fine Tuning** window. See [Color Temperature Fine Tuning](#) for details.

☞ **PIP and SWAP keys are not available.**

Installing/replacing the remote control batteries

1. Press and slide off the battery cover, as illustrated.
2. Remove the old batteries (if applicable) and install two AAA batteries within. Make sure that the positive and negative ends are positioned correctly, as illustrated.
3. Slide the battery cover in until it clicks into place.

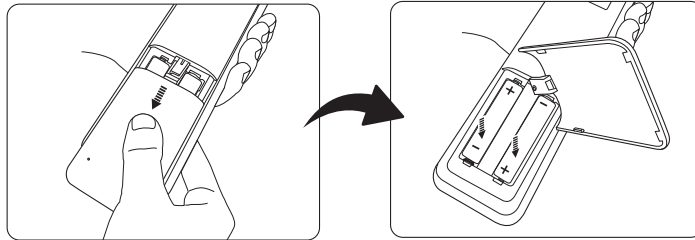

- ⚠ • **Avoid leaving the remote control and batteries in an excessive heat or humid environment like the kitchen, bathroom, sauna, sunroom or in a closed car.**
- **Replace only with the same or equivalent type recommended by the battery manufacturer.**
- **Dispose of the used batteries according to the manufacturer's instructions and local environment regulations for your region.**
- **Never throw the batteries into a fire. There may be danger of an explosion.**
- **If the batteries are dead or if you will not be using the remote control for an extended period of time, remove the batteries to avoid damage to the remote control from possible battery leakage.**

Remote control effective range

The remote control must be held at an angle within 30 degrees perpendicular to the projector's IR remote control sensor(s) to function correctly. The distance between the remote control and the sensor(s) should not exceed 8 meters (~ 26 feet).

Make sure that there are no obstacles between the remote control and the IR sensor(s) on the projector.

- **Operating the projector from the front**
- **Operating the projector from the top**

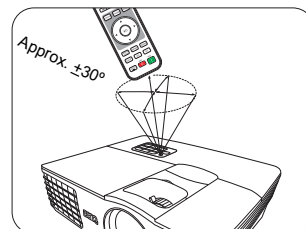
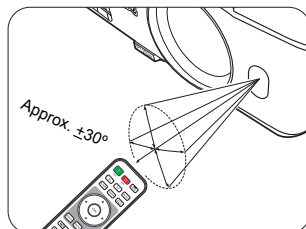



Installation

Choosing a location

Before choosing an installation location for your projector, take the following factors into consideration:

- Size and position of your screen
- Electrical outlet location
- Location and distance between the projector and the rest of your equipment

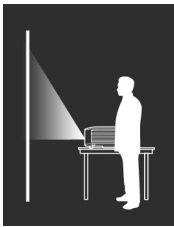
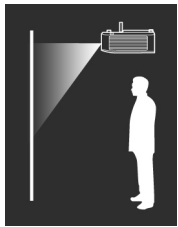
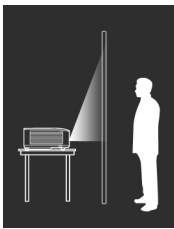
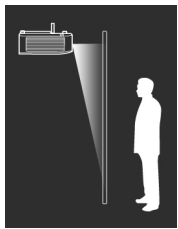
You can install your projector in the following ways.

<p>1. Front:</p> <p>Select this location with the projector placed near the floor in front of the screen.</p> <p>This is the most common way to position the projector for quick setup and portability.</p> <p>Turn on the projector and make the following settings:</p> <p>MENU > Settings or System Setup : Basic > Projector Position > Front</p>		<p>3. Front Ceiling:</p> <p>Select this location with the projector suspended from the ceiling in front of the screen.</p> <p>Turn on the projector and make the following settings:</p> <p>MENU > Settings or System Setup : Basic > Projector Position > Front Ceiling</p>		
<p>2. Rear:</p> <p>Select this location with the projector placed near the floor behind the screen.</p> <p>Turn on the projector and make the following settings:</p> <p>MENU > Settings or System Setup : Basic > Projector Position > Rear</p>			<p>4. Rear Ceiling:</p> <p>Select this location with the projector suspended from the ceiling behind the screen.</p> <p>Turn on the projector and make the following settings:</p> <p>MENU > Settings or System Setup : Basic > Projector Position > Rear Ceiling</p>	
<p> A special rear projection screen is required.</p>		<p> A special rear projection screen and the BenQ Projector Ceiling Mount Kit are required.</p>		

Obtaining a preferred projected image size

The projected image size is determined by the distance from the projector lens to the screen, the zoom setting, and the video format.

 HTI075 is equipped with movable lens. See [‘Shifting the projection lens vertically \(HTI075 only\) for details.](#)

Projection dimensions

Use the illustration and tables below to help you determine the projection distance.

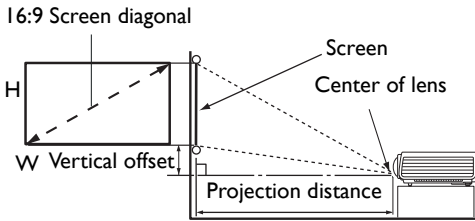

- The screen aspect ratio is 16:9 and the projected picture is in 16:9 aspect ratio

HTI075

Screen size				Projection distance (mm)			Vertical offset (mm)
Diagonal		H (mm)	W (mm)	Min. distance	Average	Max. distance	
Inch	mm			(max. zoom)		(min. zoom)	
40	1016	498	886	1013	1165	1316	25
60	1524	747	1328	1519	1747	1975	37
80	2032	996	1771	2025	2329	2633	50
100	2540	1245	2214	2532	2911	3291	62
120	3048	1494	2657	3038	3494	3949	75
140	3556	1743	3099	3544	4076	4608	87
160	4064	1992	3542	4051	4658	5266	100
180	4572	2241	3985	4557	5241	5924	112
200	5080	2491	4428	5063	5823	6582	125

HTI085ST

Screen size				Projection distance (mm)			Vertical offset (mm)
Diagonal		H (mm)	W (mm)	Min. distance	Average	Max. distance	
Inch	mm			(max. zoom)		(min. zoom)	
40	1016	498	886	609	670	731	12
60	1524	747	1328	913	1005	1096	19
80	2032	996	1771	1218	1339	1461	25
100	2540	1245	2214	1522	1674	1826	31
120	3048	1494	2657	1826	2009	2192	37
140	3556	1743	3099	2131	2344	2557	44
160	4064	1992	3542	2435	2679	2922	50
180	4572	2241	3985	2740	3014	3288	56
200	5080	2491	4428	3044	3349	3653	62

 All measurements are approximate and may vary from the actual sizes. If you want a permanent installation of the projector, we recommend that you use the actual projector to physically test the projection size, distance, and the projector's optical characteristics prior to the installation. This helps you determine the exact mounting position which best suits your installation.

Shifting the projection lens vertically (HT1075 only)

The vertical lens shift control provides flexibility for installing your projector. It allows the projector to be positioned slightly above or below the top level of the projected images.

The lens shift (offset) is expressed as a percentage of the projected image height. It is measured as an offset from the projected image's vertical center. Use the lever to shift the projection lens upwards or downwards within the allowable range depending on your desired image position.

To use the lens shift lever:

1. Release the lever by turning it counterclockwise.
2. Move the lever to adjust the projected image position.
3. Lock the lever by turning it clockwise.

• When the screen position is fixed

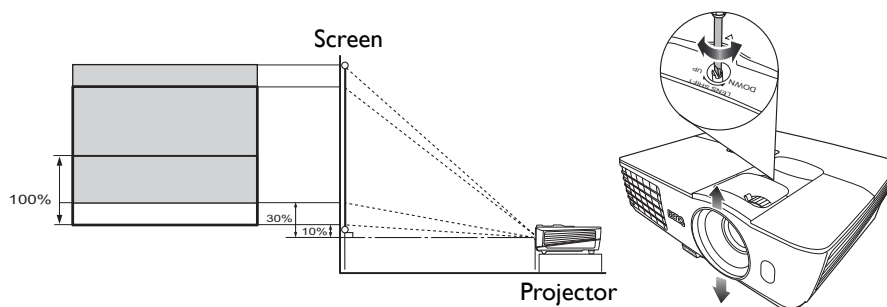

• When the projector position is fixed

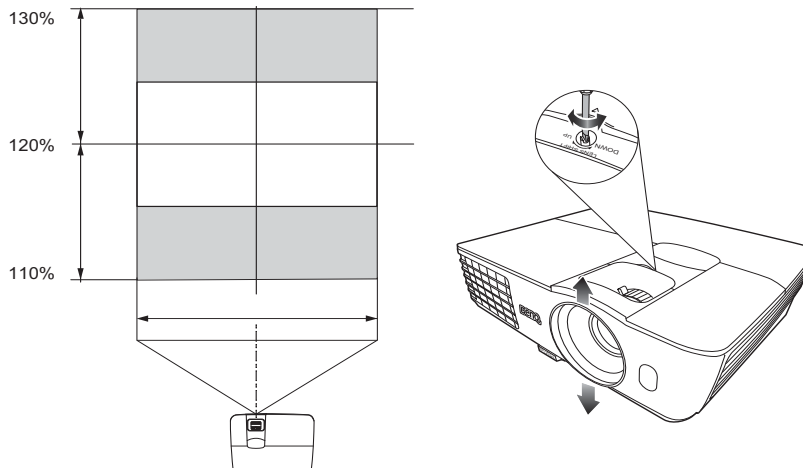

- **Do not over-tighten the lever.**
- **Lens shift adjustment does not result in a degraded picture quality. In the unlikely event that the image distortion is produced, see [Adjusting the projected image](#) for details.**

Connection

When connecting a signal source to the projector, be sure to:

1. Turn all equipment off before making any connections.
2. Use the correct signal cables for each source.
3. Make sure the cables are firmly inserted.

- ☞ **In the connection illustrations shown below, some cables may not be included with the projector (see [Shipping contents](#)). They are commercially available from electronics stores.**
- **The illustrations below are for reference only. The rear connecting jacks available on the projector vary with each projector model.**

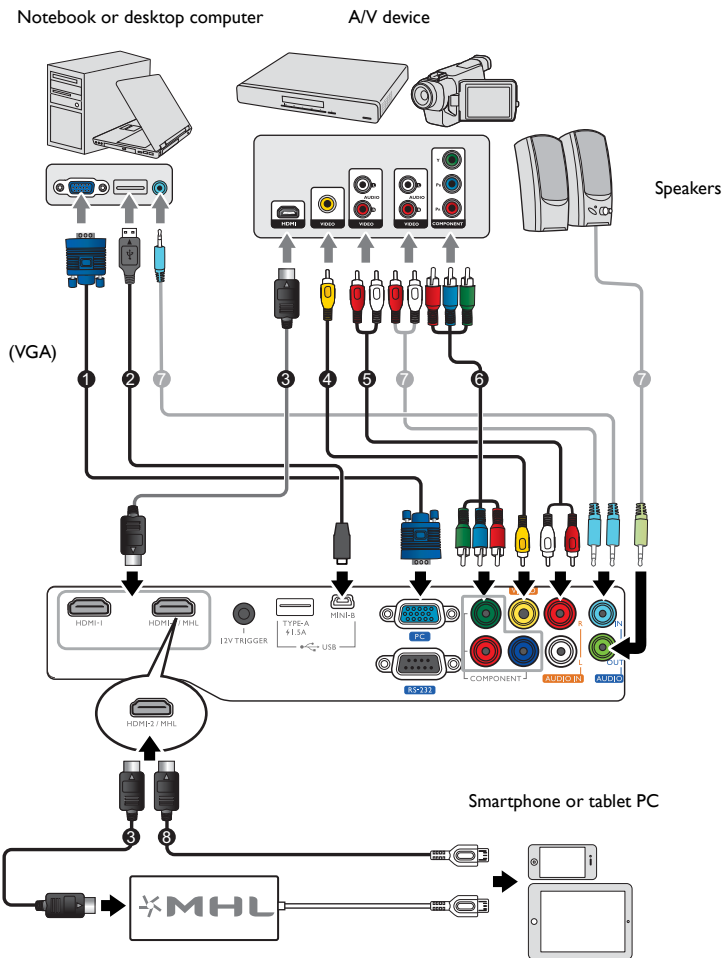





- | | | |
|---------------|--------------------------|-------------------------|
| 1. VGA cable | 4. Video cable | 7. Audio cable |
| 2. USB cable* | 5. Audio L/R cable | 8. HDMI-Micro USB cable |
| 3. HDMI cable | 6. Component video cable | |

*For updating the firmware.

Connecting with video equipment

You need only connect the projector to a video source device using just one of the connecting methods. Each video source provides different picture quality. The method you choose most likely depends upon the availability of matching terminals on both the projector and the video source device as described below:

Terminal name	Terminal appearance	Reference	Picture quality
HDMI-1 HDMI-2/MHL		<ul style="list-style-type: none"> • Connecting HDMI devices • Connecting smart devices 	● Best
COMPONENT		Connecting component-video devices	● Better
VIDEO		Connecting video devices	○ Normal
PC (D-SUB)		Connecting a computer	● Better

 In the connection illustrations shown below, some cables may not be included with the projector (see [Shipping contents](#)). They are commercially available from electronics stores.

Connecting HDMI devices

HDMI (High-Definition Multimedia Interface) supports uncompressed video data transmission between compatible devices like DTV tuners, DVD players, Blu-ray players and displays over a single cable. You should use an HDMI cable when making a connection between the projector and HDMI devices.

HDMI device: DVD player, digital tuner, etc.

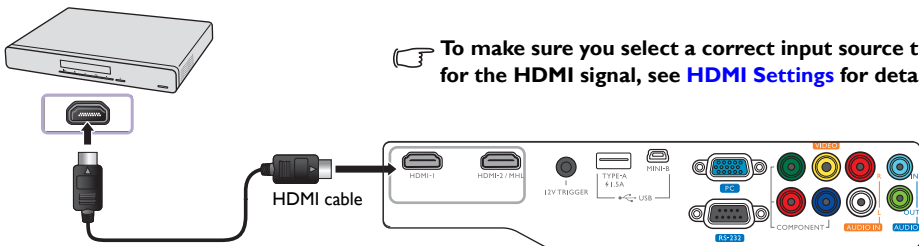

Connecting smart devices

The projector can project the content directly from a MHL compatible smart device. Using an HDMI to Micro USB cable or an HDMI to Micro USB adaptor, you can connect your smart devices to the projector and then enjoy your content on the big screen.

Some smart devices may not be compatible to the cable that you use. Please consult the manufacturer of your smart device for detailed information.

Using an HDMI to Micro USB cable

1. Connect one end of the HDMI to Micro USB cable to the HDMI input connector on the projector.
2. Connect the other end of the HDMI to Micro USB cable to the Micro USB output socket on your smart device.
3. Switch to the HDMI/MHL input source. To switch input signal, see [Selecting an input source](#) for details.

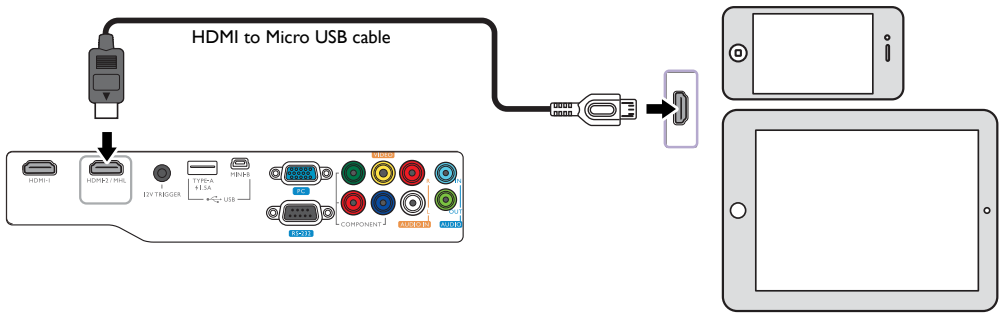

Using an HDMI to Micro USB adaptor and an HDMI cable

1. Connect one end of the HDMI cable to the HDMI input connector on the projector.
2. Connect the other end of the HDMI cable to the HDMI input socket on the adaptor.
3. Connect the other end of the adaptor to the Micro USB output socket on your smart device.
4. Switch to the HDMI/MHL input source. To switch input signal, see [Selecting an input source](#) for details.

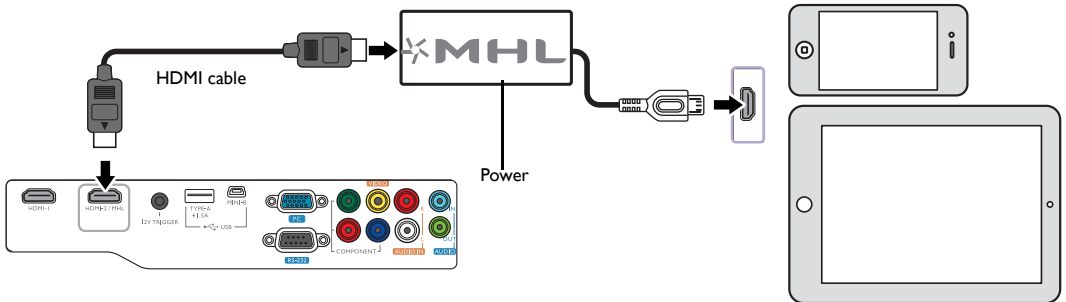

Connecting component-video devices

The RCA type component video jacks are provided for connection to video output devices. You should also connect the separate audio cable to a suitable audio amplifier.

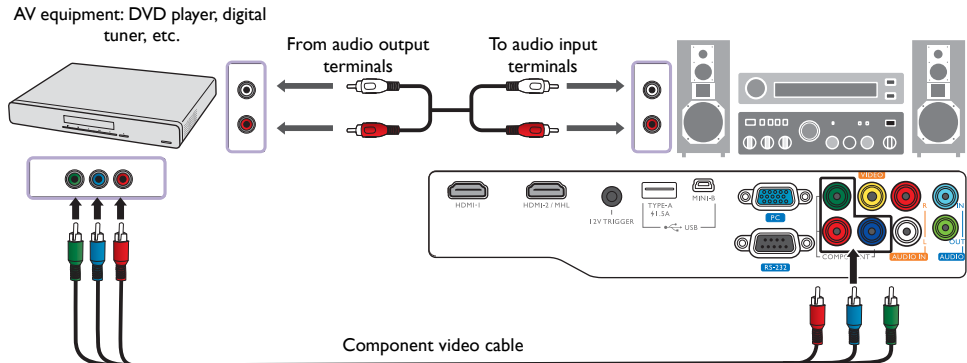

Connecting video devices

Connect your video device to the projector with a composite video cable. You should also connect the separate audio cable to a suitable audio amplifier.

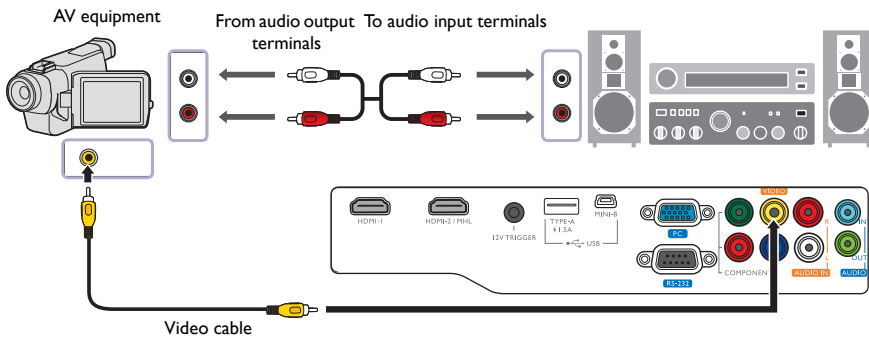

☞ If the selected video image is not displayed after the projector is turned on and the correct video source has been selected, check if the video source device is turned on and operating correctly.

Connecting a computer

Connect the projector to a computer with a VGA cable.

Laptop or desktop computer

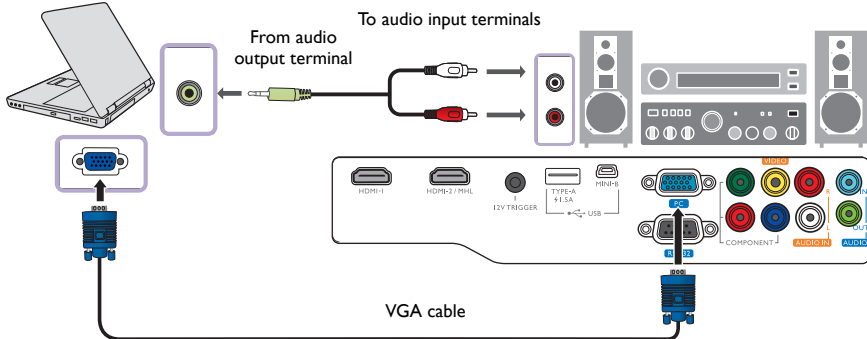



Many laptops do not turn on their external video ports when connected to a projector. Usually a key combination like Fn + F3 or CRT/LCD key turns the external display on/off. Locate a function key labeled CRT/LCD or a function key with a monitor symbol on the laptop. Press Fn and the labeled function key simultaneously. Refer to your laptop's documentation to discover your laptop's key combination.

Operation

Starting up the projector





1. Plug the power cable into the projector and into a power outlet. Turn on the power outlet switch (where fitted). The **POWER indicator light** on the projector lights orange after power has been applied.

⚠ **Please use the supplied power cable to avoid possible dangers such as electric shock and fire.**

2. Press  on the projector or  on the remote control to start the projector. As soon as the lamp lights up, a **Power On Tone** will be heard. The **POWER indicator light** flashes green and stays green when the projector is on.

The fans starts operating, and a start-up image displays on the screen while it warms up. The projector does not respond to further commands while it is warming up.

👉 **To turn off the ring tone, see [Power On/Off Ring Tone](#) for details.**

3. If this is the first time you turn on the projector, the setup wizard appears to guide you through setting up the projector. If you have already done this, skip this step and move on to step 4.
 - Use the arrow keys (///) on the projector or remote control to move through the menu items.
 - Use **OK** to confirm the selected menu item.

👉 **The Setup Wizard screenshots below are for reference only and may differ from the actual design.**

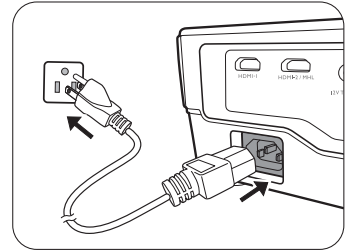

Step 1:

Specify **Projector Position**.

👉 **For more information about projector position, see [Choosing a location](#).**

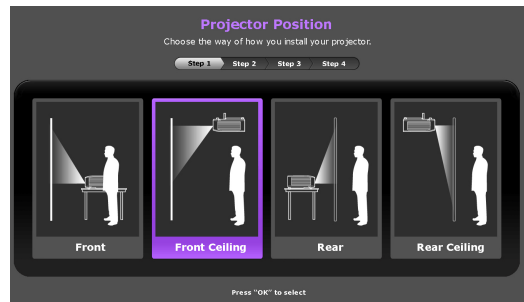

Step 2:

Specify OSD **Language**.

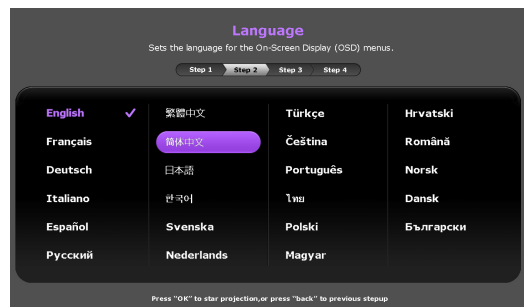

Step 3:
Specify **2D Keystone**.

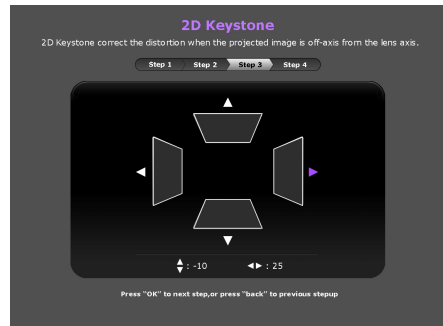



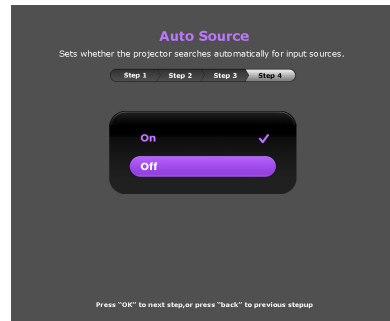

Step 4:
Specify **Auto Source**.

Now you've completed the initial setup.



4. If you are prompted to enter the password, use the arrow keys on the projector or remote control to enter a six-digit password. See [Utilizing the password function](#) for details.
5. Switch on the connected equipment.
6. The projector starts to search for available input signals. The current input signal being scanned displays on the screen. If the projector doesn't detect a valid signal, the **"No Signal"** message appears. You may press **SOURCE** on the projector or remote control to select your desired input signal.
7. If the horizontal frequency of the input source exceeds the range of the projector, the **"No Signal"** message displays on the screen. It will remain on-screen until you change the input source to an appropriate one.

Shutting down the projector

1. Press  on the projector or  on the remote control. The projector displays a shutdown confirmation message.
2. Press  or  a second time. The **POWER indicator light** flashes orange and the fans run for about two minutes to cool the lamp. The projector doesn't respond to any commands during the cooling process.
3. When the cooling process ends, a **"Power Off Ring Tone"** will be heard, and the **POWER indicator light** will show a solid orange.

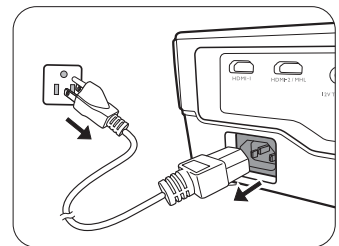

 To turn off the ring tone, see [Power On/Off Ring Tone](#) for details.

If the projector will not be used for an extended period, unplug the power cable from the power outlet.

 Avoid turning on the projector immediately after turning it off as excessive heat may shorten lamp life.

The actual lamp life may vary due to different environmental conditions and usage.

Securing the projector

Using a security cable lock

The projector has to be installed in a safe place to prevent theft. Otherwise, purchase a lock, such as the Kensington lock, to secure the projector. You can locate a Kensington lock slot on the projector. See item 28 on page 9 for details.

A Kensington security cable lock is usually a combination of key(s) and the lock. Refer to the lock's documentation to learn how to use it.

Utilizing the password function

For security purposes and to prevent unauthorized use, you may set up password security via the On-Screen Display (OSD) menu. Once the password is set and the function is enabled, the projector is password-protected. Users who do not know the correct password may not use the projector.

⚠ You will be inconvenienced if you enable the password function yet forget the password somehow. Do make a note of your password, and keep the note in a safe place for later recall.

Setting a password

👉 Once a password has been set and the power on lock is enabled, the projector cannot be used unless the correct password is entered every time the projector is started.

To do this, first and foremost, you have to access the **Advanced** OSD menu (see 30 for details).

1. Go to **System Setup : Advanced > Password** to display the **Password** window.
2. Select **Change Password** and press **OK** to display the **Input Password** window.

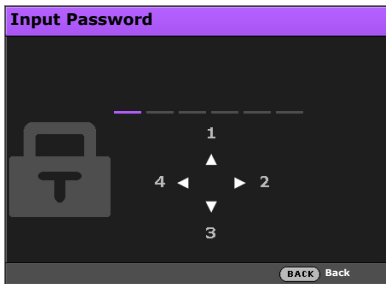

3. As the window indicates, the four arrow keys (▲/▶/▼/◀) respectively represent 4 digits (1, 2, 3, 4). Use the arrow keys on the projector or remote control to set a six-digit password. The digits display as ***** when you enter them.
4. Re-enter the same password to verify and return to the **Password** window.
5. Select **Power On Lock** and use ◀/▶ to set **On**.
6. Enter the current password to enable the function.
7. Press **BACK** to save your changes and exit.

If you forget the password

If you enable the password function, you'll have to enter your password each time you turn on the projector. Once you enter an incorrect password, the error message displays, and the **Input Password** window follows.

- Under the **Advanced OSD** menu

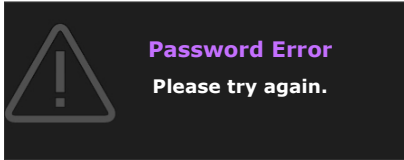

- Under the **Basic OSD** menu

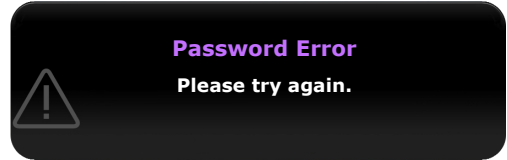

You can retry by entering another six-digit password, or if you absolutely do not remember it, use the password recall procedure. See [Entering the password recall procedure](#) for details.

If you have entered an incorrect password 5 times in succession, the projector will automatically shut down in a short time.

Entering the password recall procedure

1. Make sure the **Password** window displays on screen, then press and hold **AUTO** on the projector or remote control for 3 seconds. The projector will display a coded number on the screen.

- Under the **Advanced OSD** menu

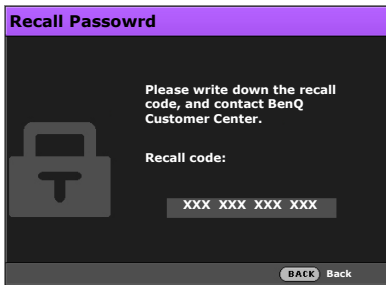

- Under the **Basic OSD** menu

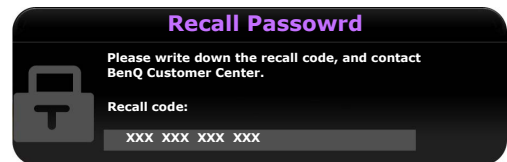

2. Write down the number and turn off the projector.
3. Seek help from the local BenQ service center to decode the number. You may be required to provide proof of purchase documentation to verify that you are an authorized user of the projector.

☞ "XXX" shown in the above messages are numbers that vary depending on different models.

Changing the password

To do this, first and foremost, you have to access the **Advanced** OSD menu (see [30](#) for details).

1. Go to **System Setup : Advanced > Password** to display the **Password** window.
2. Select **Change Password** and press **OK** to display the **Input Current Password** window.

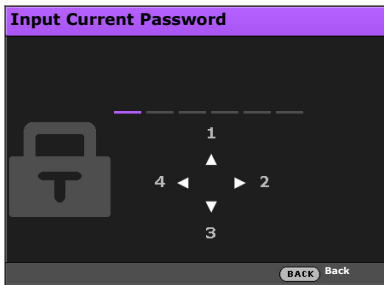

3. Use the arrow keys on the projector or remote control to enter the old password.
 - If the password is correct, the **Input New Password** window displays.
 - If the password is incorrect, the error message displays, and the **Input Current Password** window displays for your retry. You can either try another password or press **BACK** to cancel the change.
4. Enter a new password.
5. Re-enter the same password to verify.

 **Do make a note of your password, and then keep the note in a safe place for later recall.**

6. You have successfully set a new password. Remember to enter the new password next time you turn on the projector.
7. Press **BACK** to save your changes and exit.

Disabling the password function

To do this, first and foremost, you have to access the **Advanced** OSD menu (see [30](#) for details).

1. Go to **System Setup : Advanced > Password** to display the **Password** window.
2. Select **Power On Lock** and use **◀/▶** to set **Off**.
3. Enter the current password.
 - If the password is correct, the **Password** window displays that **Power On Lock** is **Off**. You will not be asked to enter the password next time when turning on the projector.
 - If the password is incorrect, the password error message displays, and then the **Input Current Password** window displays for your retry. You can either try another password or press **BACK** to cancel the change.
4. Press **BACK** to save your changes and exit.

 **Though the password function is disabled, you need to keep a note of the old password in case you ever need to re-activate the password function by entering the old password.**

Selecting an input source

The projector can be connected to multiple equipment at the same time. However, it only displays one full screen at a time. When starting up, the projector automatically searches for the available signals.

If you want the projector to always automatically search for the signals:

- Under the **Advanced** OSD menu, go to the **System Setup : Basic** menu, and enable **Auto Source**. (see "[Auto Source](#)" on page 43)
- Under the **Basic** OSD menu, if there's no signal connected to the projector, go to **Auto Source** and enable it; if there are signals connected, go to the **Settings** menu, and then enable **Auto Source**. (see "[Auto Source](#)" on page 32 and 34)

To select the video source:

1. Press **SOURCE** on the projector or remote control to display the source selection bar.

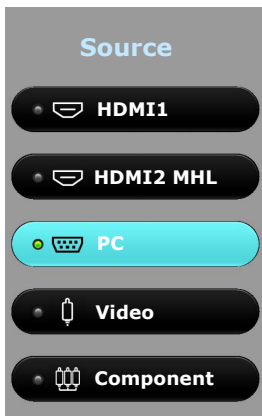

2. Press **▲/▼** until your desired signal is selected and press **OK**.
Once detected, the selected source information displays on the screen for seconds. If there are multiple pieces of equipment connected to the projector, repeat steps 1-2 to search for another signal.

 **The native display resolution of this projector is in a 16:9 aspect ratio. For best display picture results, you should select and use an input signal which outputs at this resolution. Any other resolutions will be scaled by the projector depending upon the Aspect Ratio setting, which may cause some image distortion or loss of picture clarity. See "[Aspect Ratio](#)" for details.**

Renaming an input source

You may rename the current input source on the source selection bar.

To do this, first and foremost, you have to access the **Advanced** OSD menu (see [30](#) for details).

1. Press **MENU** and then use **◀/▶** to go to **System Setup : Basic**.
2. Press **▼** to select **Source Rename** and press **OK** to display the **Source Rename** window.
3. Press **▲/▼/◀/▶** until your desired character is selected.
4. When done, press **BACK** to save your changes and exit.

Adjusting the projected image

Adjusting the projection angle

The projector is equipped with a quick-release adjuster foot and a rear adjuster foot. These adjusters change the image height and projection angle.

To adjust the projector:

1. Press the quick-release button and lift the front of the projector. Once the image is positioned as desired, release the quick-release button to lock the foot in position.
2. Screw the rear adjuster foot to fine-tune the horizontal angle.

To retract the foot, hold up the projector while pressing the quick-release button, then slowly lower the projector. Screw the rear adjuster foot in a reverse direction.

 If the screen and the projector are not perpendicular to each other, the projected image becomes vertical trapezoidal. To correct this, see [Auto-adjusting the image](#) for details.

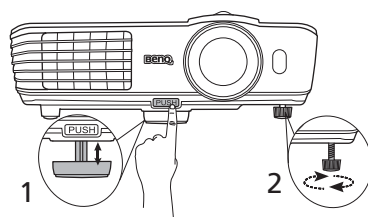

 **Do not look into the lens while the lamp is on. The strong light from the lamp may cause damage to your eyes.**

Be careful when you press the quick-release button as it is close to the exhaust vent where hot air comes from.

Auto-adjusting the image

In some cases, you may wish to optimize the picture quality. To do this, press **AUTO** on the projector or remote control. Within 3 seconds, the built-in Intelligent Auto Adjustment function will re-adjust the values of Frequency and Clock to provide the best picture quality.

The current input source information will be displayed in the corner of the screen for 3 seconds.

 **This function is only available when PC signal is selected.**

Fine-tuning the image size and clarity

To adjust the projected picture size, turn the zoom ring on the projector.

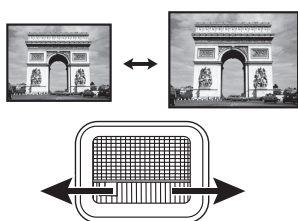

To sharpen the picture, rotate the focus ring on the projector.

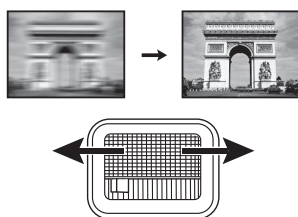

Correcting keystone

Keystoning refers to the situation where the projected image is noticeably wider at either the top or bottom. It occurs when the projector is not perpendicular to the screen.

You may correct this in ONE of these ways.

- **Using the remote control**

Press **KEYSTONE** to display the **2D Keystone** window.

- **Using the projector**

Press **▲/▼**, **◀/▶**, **◀/▶**, or **▼/▲** to display the **2D Keystone** window.



- To correct keystone at the top of the image, use ▼ or ▲/▼.
- To correct keystone at the bottom of the image, use ▲ or ▲/▼.
- To correct keystone at the right side of the image, use ◀ or ◀/▶.
- To correct keystone at the left side of the image, use ▶ or ▶/▶.

When done, press **BACK** to save your changes and exit.

Menu Functions

About the OSD Menu

To let you make various adjustments or settings on the projector and the projected image, the projector is equipped with 2 types of multilingual On-Screen Display (OSD) menus:

- **Basic** OSD menu: provides primary menu functions. (See [Using the Basic OSD menu](#))
- **Advanced** OSD menu: provides full menu functions. (See [Using the Advanced OSD menu](#))

To access the OSD menu, press **MENU** on the projector or remote control.

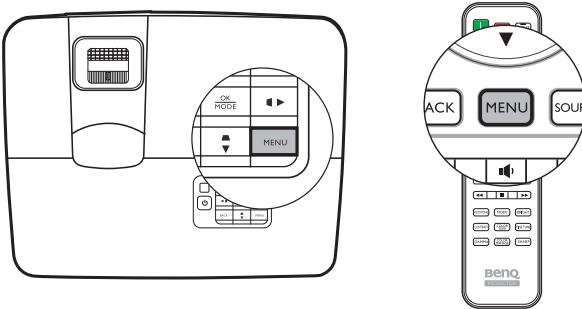

The first time you use the projector (after finishing the initial setup), one of the following **Basic** OSD menu overviews displays, depending on whether or not any video signal is connected.

• Input signal connected



• No input signal connected

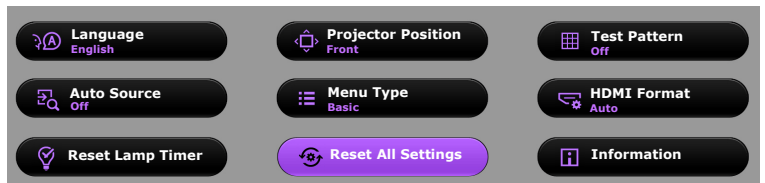

If you intend to switch from the **Basic** OSD menu to the **Advanced** OSD menu, follow the instructions below:

☞ Use the arrow keys (◀/▶/▲/▼) on the projector or remote control to move through the menu items, and use **OK** to confirm the selected menu item.

- When there is a video signal connected to the projector
 - i. Go to the **Settings > Menu Type** menu.
 - ii. Use ▲/▼ to select **Advanced** and press **OK**.
 - iii. Press **MENU** again to access the **Advanced** OSD menu.
- When there is **NO** video signal connected to the projector
 - i. Go to the **Menu Type** menu.
 - ii. Use ▲/▼ to select **Advanced** and press **OK**.
 - iii. Press **MENU** again to access the **Advanced** OSD menu.

Next time when you turn on the projector, you may access the **Advanced** OSD menu by pressing **MENU**.

Below is the overview of the **Advanced** OSD menu.

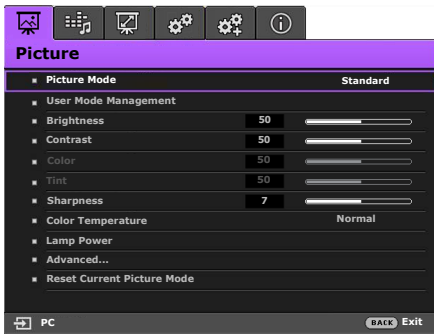

Likewise, when you wish to switch from the **Advanced** OSD menu to the **Basic** OSD menu, follow the instructions below:

- i. Go to the **System Setup : Basic > Menu Settings > Menu Type** menu.
- ii. Use ◀/▶ to select **Basic**.
- iii. Press **MENU** again to access the **Basic** OSD menu.

Next time when you turn on the projector, you may access the **Basic** OSD menu by pressing **MENU**.

Using the **Basic** OSD menu

Depending on whether or not any video signal is connected to the projector, the **Basic** OSD menu offers different available functions.

Check the following links to learn more.

- [Basic OSD menu - with input signals connected](#)
- [Basic OSD menu - without input signals connected](#) (limited menus are available)



Basic OSD menu - with input signals connected







The **Basic** OSD menu provides primary menu functions. Available menu items may vary depending on the connected video sources or specified settings. Menu options that are not available will become grayed out.





To access the OSD menu, press **MENU** on the projector or remote control.

- Use the arrow keys (◀/▶/▲/▼) on the projector or remote control to move through the menu items.
- Use **OK** to confirm the selected menu item.

 To switch from the **Basic OSD** menu to the **Advanced OSD** menu, see page 30.

Menu	Submenus and Descriptions
<p>Picture Mode</p>	<p>Selects a preset picture mode to suit your operating environment and input signal picture type.</p> <p>The preset picture modes are described as below:</p> <ul style="list-style-type: none"> • Bright: Maximizes the brightness of the projected image. This mode is suitable for environments where extra-high brightness is required, such as using the projector in well lit rooms. • Cinema: With well-balanced color saturation and contrast with a low brightness level, this is most suitable for enjoying movies in a totally dark environment (as you would find in a commercial cinema). • Standard: Being slightly brighter than Cinema mode, it is suitable for use in rooms where there is a small amount of ambient light. • 3D: It is optimized to bring up 3D effects when watching 3D contents. <p> This mode is only available when 3D function is enabled.</p> <ul style="list-style-type: none"> • User 1/User 2: Recalls the customized settings. Access the Advanced OSD menu and see User Mode Management for details. <p> The function is accessible through the remote control.</p>
<p>Sound Mode</p>	<p>Selects a sound effect mode to your preference. The following preset sound modes are provided: Standard, Cinema, Music, Sport, and User.</p> <p>To specify the sound settings of the User mode, access the Advanced OSD menu and see User EQ for details.</p> <p> If the Mute function is activated, adjusting Sound Mode will turn off the Mute function.</p>

Volume	<p>Adjusts the volume level of the projector's internal speaker or the volume being output from the audio output jack.</p> <p> If the Mute function is activated, adjusting Volume will turn off the Mute function.</p> <p> The function is accessible through the remote control.</p>
Mute	<p>Selects On to temporarily turn off the projector's internal speaker or the volume being output from the audio output jack.</p> <p>To restore the audio, select Off.</p> <p> The function is accessible through the remote control.</p>
3D Mode	<p>This projector supports playing three-dimensional (3D) content transferred through your 3D-compatible video devices and contents, such as PlayStation consoles (with 3D game discs), 3D Blu-ray 3D players (with 3D Blu-ray discs), 3D TV (with 3D channel), and so on. After you have connected the 3D video devices to the projector, wear the BenQ 3D glasses and make sure the power is on to view 3D contents.</p> <p> When watching 3D contents,</p> <ul style="list-style-type: none"> • the image may seem misplaced, however, this is not a product malfunction. • take appropriate breaks when watching 3D content. • stop watching 3D content if you feel fatigue or discomfort. • keep a distance from the screen of about three times the effective height of the screen when watching 3D content. • children and people with a history of oversensitivity to light, heart problems, or have any other existing medical condition should be refrained from watching 3D content. <p>The default setting is Auto and the projector automatically chooses an appropriate 3D format when detecting 3D contents. If the projector cannot recognize the 3D format, manually choose a 3D mode according to your preference.</p> <p> When this function is enabled:</p> <ul style="list-style-type: none"> • The brightness level of the projected image decreases. • The Picture Mode cannot be adjusted. • The 2D Keystone can only be adjusted within limited degrees. <p> The function is accessible through the remote control.</p>
3D Sync Invert	<p>When your 3D image is distorted, enable this function to switch between the image for the left eye and the right eye for the more comfortable 3D viewing experience.</p> <p> The function is accessible through the remote control.</p>
Settings	Press OK to enter its submenu. See below for more details.
• Language	Sets the language for the On-Screen Display (OSD) menus.
• Projector Position	The projector can be installed on a ceiling or behind a screen, or with one or more mirrors. See Choosing a location for details.
• Test Pattern	Enables this function to display the grid test pattern, which helps you adjust the image size and focus so as to check if the projected image is free of distortion.
• Auto Source	Sets whether the projector searches automatically for input sources. Select On to enable the projector to scan for input sources until it acquires a signal. If the function is set to Off , the projector selects the last used input source.
• Menu Type	Switches to the Advanced OSD menu.

<ul style="list-style-type: none"> • HDMI Format 	<p>Selects an input source type for the HDMI signal. You can also manually select the source type. The different source types carry different standards for the brightness level.</p> <p> HDMI Format is only available when the HDMI signal is selected.</p>
<ul style="list-style-type: none"> • Reset Lamp Timer 	<p>Activates this function only after a new lamp is installed. When you select Reset, a "Reset Successfully" message displays to notify that the lamp time has been reset to "0".</p>
<ul style="list-style-type: none"> • Reset All Settings 	<p>Returns all settings to the factory preset values.</p> <p> The following settings will still remain: Keystone, Language, Projector Position, and Reset Lamp Timer.</p>
<ul style="list-style-type: none"> • Information 	<p>Displays the following information about your projector.</p> <ul style="list-style-type: none"> • Source: Displays the current signal source. • Picture Mode: Displays the current Picture Mode. • Resolution: Displays the native resolution of the input source. • Color System: Displays input system format. • Equivalent Lamp Hour: Displays the number of hours the lamp has been used. • 3D Format: Displays the current 3D mode. <p> 3D Format is only available when 3D Mode is enabled.</p> <ul style="list-style-type: none"> • Firmware Version: Displays the firmware version of your projector. <p> Some information is given only when certain input sources are in use.</p>





Basic OSD menu - without input signals connected

As there's no input signal to your projector, only the submenus of **Settings** under **Basic** OSD menu - with input signals connected are available. Menu options that are not available will become grayed out.

To access the OSD menu, press **MENU** on the projector or remote control.

- Use the arrow keys (◀/▶/▲/▼) on the projector or remote control to move through the menu items.
- Use **OK** to confirm the selected menu item.

 To switch from the **Basic OSD** menu to the **Advanced OSD** menu, see page 30.

Menu	Submenus and Descriptions
Language	Sets the language for the On-Screen Display (OSD) menus.
Projector Position	The projector can be installed on a ceiling or behind a screen, or with one or more mirrors. See Choosing a location for details.
Test Pattern	Enables this function to display the grid test pattern, which helps you adjust the image size and focus so as to check if the projected image is free of distortion.
Auto Source	Sets whether the projector searches automatically for input sources. Select On to enable the projector to scan for input sources until it acquires a signal. If the function is set to Off , the projector selects the last used input source.
Menu Type	Switches to the Advanced OSD menu.
HDMI Format	Selects an input source type for the HDMI signal. You can also manually select the source type. The different source types carry different standards for the brightness level.  HDMI Format is only available when the HDMI signal is selected.
Reset Lamp Timer	Activates this function only after a new lamp is installed. When you select Reset , a " Reset Successfully " message displays to notify that the lamp time has been reset to "0".
Reset All Settings	Returns all settings to the factory preset values.  The following settings will still remain: Keystone, Language, Projector Position, and Reset Lamp Timer.
Information	Displays the following information about your projector. <ul style="list-style-type: none"> • Source: Displays the current signal source. • Picture Mode: Displays the current Picture Mode. • Resolution: Displays the native resolution of the input source. • Color System: Displays input system format. • Equivalent Lamp Hour: Displays the number of hours the lamp has been used. • 3D Format: Displays the current 3D mode.  3D Format is only available when 3D Mode is enabled. • Firmware Version: Displays the firmware version of your projector.  Some information is given only when certain input sources are in use.

Using the **Advanced** OSD menu

The **Advanced** OSD menu offers complete menu functions.

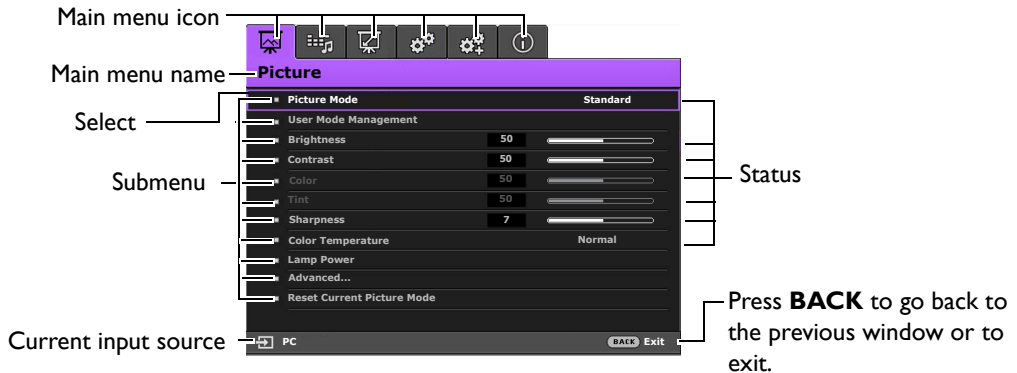

The **Advanced OSD** menu overview above is for reference only and may differ from the actual design and the projector model you are using.

To access the OSD menu, press **MENU** on the projector or remote control. It is consisted of the following main menus. Check the links after the menu items below to learn more details.

1. **Picture** menu (see page 36)
2. **Audio Setup** menu (see page 40)
3. **Display** menu (see page 41)
4. **System Setup : Basic** menu (see page 43)
5. **System Setup : Advanced** menu (see page 44)
6. **Information** menu (see page 46)





Available menu items may vary depending on the connected video sources or specified settings. Menu items that are not available will become grayed out.

- Use the arrow keys (◀/▶/▲/▼) on the projector or remote control to move through the menu items.
- Use **OK** to confirm the selected menu item.

To switch from the **Advanced OSD** menu to the **Basic OSD** menu, see page 30.

Picture menu

Submenu	Functions and Descriptions
<p>Picture Mode</p>	<p>Selects a preset picture mode to suit your operating environment and input signal picture type.</p> <p>The preset picture modes are described as below:</p> <ul style="list-style-type: none"> • Bright: Maximizes the brightness of the projected image. This mode is suitable for environments where extra-high brightness is required, such as using the projector in well lit rooms. • Cinema: With well-balanced color saturation and contrast with a low brightness level, this is most suitable for enjoying movies in a totally dark environment (as you would find in a commercial cinema). • Standard: Being slightly brighter than Cinema mode, it is suitable for use in rooms where there is a small amount of ambient light. • 3D: It is optimized to bring up 3D effects when watching 3D contents. <p>☞ This mode is only available when 3D function is enabled.</p> <ul style="list-style-type: none"> • User 1/User 2: Recalls the customized settings. See User Mode Management for more details. <p>☞ The function is accessible through the remote control.</p>
<p>User Mode Management</p>	<p>☞ The functions are only available when Picture Mode is set to User 1 or User 2.</p> <ul style="list-style-type: none"> • Load Settings From <p>Allows you to manually adjust a preset picture mode and make it an available option on the picture mode list.</p> <ol style="list-style-type: none"> 1. Go to the Picture > Picture Mode menu, select User 1 or User 2. 2. Press ▼ to select User Mode Management. 3. On the User Mode Management window, select Load Settings From and press OK. 4. Press ▼ to select a picture mode that is close to your need. 5. When done, press OK and BACK to return to the Picture menu. 6. Press ▼ to select other submenus you want to make changes and use ◀/▶ to adjust the values. The adjustments define the selected user mode. <ul style="list-style-type: none"> • Rename User Mode <p>Selects to rename the customized picture modes (User 1 or User 2).</p> <ol style="list-style-type: none"> 1. Go to the Picture > Picture Mode menu, select User 1 or User 2. 2. Press ▼ to select User Mode Management. 3. On the User Mode Management window, select Rename User Mode and press OK. 4. On the Rename User Mode window, use ▲/▼/◀/▶ to select desired characters for the selected mode. 5. When done, press OK and BACK to exit.
<p>Brightness</p>	<p>Adjusts the brightness of the picture. When adjusting this control, the black areas of the picture appear just as black and details in the dark areas are visible.</p> <div style="display: flex; align-items: center;">  <div style="margin-left: 20px;"> <p>The higher the value, the brighter the picture, while the lower the value, the darker the picture.</p> </div> </div> <p>☞ The function is accessible through the remote control.</p>

<p>Contrast</p>	<p>Adjusts the degree of difference between dark and light in the picture. After adjusting the Brightness value, adjust Contrast to set the peak white level.</p> <div style="display: flex; align-items: center;">  <div style="margin-left: 20px;"> <p>The higher the value, the greater the contrast.</p> </div> </div> <p> The function is accessible through the remote control.</p>
<p>Color</p>	<p>Adjusts the color saturation level -- the amount of each color in a video picture. Lower settings produce less saturated colors; setting to the minimum value makes the image black and white.</p> <p>If the setting is too high, colors on the image will be overpowering, which makes the image unrealistic.</p>
<p>Tint</p>	<p>Adjusts the red and green color tones of the picture.</p> <p>The higher the value, the more reddish the picture becomes. The lower the value, the more greenish the picture becomes.</p>
<p>Sharpness</p>	<p>Adjusts to make the picture look sharper or softer.</p> <div style="display: flex; align-items: center;">  <div style="margin-left: 20px;"> <p>The higher the value, the sharper the picture becomes. The lower the value, the softer the picture becomes.</p> </div> </div> <p> The function is accessible through the remote control.</p>
<p>Color Temperature*</p>	<p>The options available for color temperature* settings vary according to the connected input signal.</p> <ul style="list-style-type: none"> • Lamp Native: With the lamp's original color temperature and higher brightness. This setting is suitable for environments where high brightness is required, such as projecting pictures in well lit rooms. • Warm: Makes pictures appear reddish white. • Normal: Maintains normal colorings for white. • Cool: Makes pictures appear bluish white. <p>*About color temperatures: There are many different shades that are considered to be "white" for various purposes. One of the common methods of representing white color is known as the "color temperature". A white color with a low color temperature appears to be reddish white. A white color with a high color temperature appears to have more blue in it.</p> <p> The function is accessible through the remote control.</p>
<p>Lamp Power</p>	<p>Selects the projector lamp power from the following modes.</p> <ul style="list-style-type: none"> • Normal: Provides full lamp brightness. • Economic: Reduces system noise and power consumption by 30%. • SmartEco: Reduces system noise and lamp power consumption by up to 70%. <p>If the Economic or SmartEco mode is selected, the light output will be reduced and result in darker projected pictures.</p> <p>See Setting Lamp Power for details.</p>

Advanced...

- **Black Level**

Sets the picture grayscale to **0 IRE** or **7.5 IRE**.

The grayscale video signal is measured in IRE units. In some areas which use NTSC TV standard, the grayscale is measured from 7.5 IRE (black) to 100 IRE (white); however, in other areas where PAL equipment or Japanese NTSC standards are used, the grayscale is measured from 0 IRE (black) to 100 IRE (white). We suggest you to check if the input source is with 0 IRE or with 7.5 IRE, and then make your selection accordingly.

- **Gamma Selection**

Gamma refers to the relationship between input source and picture brightness.

- **1.6/1.8/2.0/BenQ:** Selects these values according to your preference.
- **2.2:** Increases the average brightness of the picture. Best for a lit environment, meeting room or family room.
- **2.4/2.5:** Best for viewing movies in a darkened environment.
- **2.6/2.8:** Best for viewing movies which are mostly composed of dark scenes.

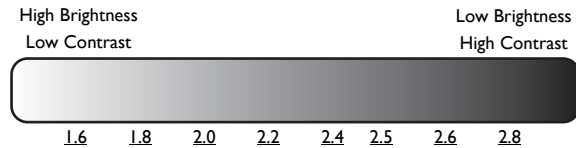

- **Brilliant Color**

This function utilizes a new color-processing algorithm and system level enhancements to enable higher brightness while providing truer, more vibrant colors in picture. It enables a greater than 50% brightness increase in mid-tone images, which are common in video and natural scenes, so the projector reproduces images in realistic and true colors. If you prefer images with that quality, select **On**. Selecting **Off** disables **Brilliant Color**, and **Color Temperature** becomes unavailable for access at the same time.

- **Color Temperature Fine Tuning**

Allows you to manually adjust the pre-defined color temperature modes:

1. Press **OK** to display the **Color Temperature Fine Tuning** window.
2. Press **▲/▼** to select the item(s) you want to make changes and use **◀/▶** to adjust the values.
 - **Red Gain/Green Gain/Blue Gain:** Adjusts the contrast levels of Red, Green, and Blue.
 - **Red Offset/Green Offset/Blue Offset:** Adjusts the brightness levels of Red, Green, and Blue.
3. When done, press **OK** and **BACK** to exit.

 **The function is accessible through the remote control.**

Advanced...

• **Color Management**

In most installation situations, color management is not necessary, such as in classroom, meeting room, or lounge room situations where lights remain on, or where building external windows allow daylight into the room.

Only in permanent installations with controlled lighting levels, such as boardrooms, lecture theaters, or home theaters, should color management be considered. Color management provides fine color control adjustment to allow for more accurate color reproduction.

Proper color management can be achieved under controlled and reproducible viewing conditions. Use a colorimeter (color light meter) and provide a set of suitable source images to measure color reproduction. These tools are not provided with the projector, however, your projector supplier should be able to give guidances or send an experienced professional installer for you.

The **Color Management** function provides six sets (RGBCMY) of colors to be adjusted. You can select any of them to adjust its color range and saturation.

1. Press **OK** to display the **Color Management** window.
2. Select **Primary Color** and use ◀/▶ to select a color from **Red, Green, Blue, Cyan, Magenta, and Yellow**.
3. Press ▼ to select **Hue** and use ◀/▶ to set its range. Increase in the range will include colors consisted of more proportions of its two adjacent colors.

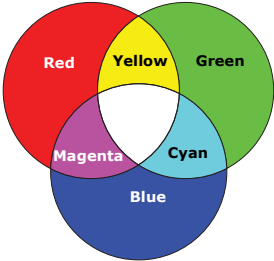

The illustration shows how the colors relate to each other.

For example, if you select **Red** and set its range at 0, only pure red is selected. Increasing its range will include both the red color close to yellow and red color close to magenta.

4. Press ▼ to select **Gain** and use ◀/▶ to adjust its values. The contrast level of the primary color you just selected are affected. Every adjustment made reflects to the image immediately.
5. Press ▼ to select **Saturation*** and use ◀/▶ to adjust its values. Every adjustment made reflects to the image immediately. For example, if you select **Red** and set its value at 0, only the saturation of pure red will be affected.
6. Repeat steps 2 to 5 until you have made all of the desired adjustments.
7. When done, press **OK** and **BACK** to exit.

*About saturation

It is the amount of that color in a video picture. Lower settings produce less saturated colors; a setting of “0” removes that color from the image entirely. If the saturation is too high, that color will be overpowering and unrealistic.

☞ **The function is accessible through the remote control.**

Noise Reduction





Reduces electrical image noise caused by different media players. The higher the value, the less the noise.

Film Mode



Enhances picture quality when projecting composite image from a filmsourced DVD or Blu-ray Disc. Setting **Off** disables the function.





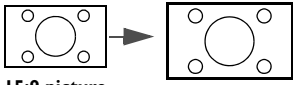
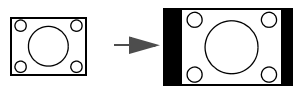
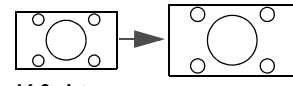
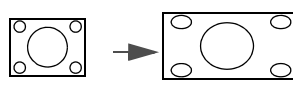
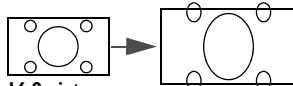
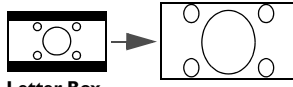

Reset Current Picture Mode	<p>All of the adjustments you've made for the selected Picture Mode (including preset modes, User 1, and User 2) return to the factory preset values.</p> <ol style="list-style-type: none"> 1. Press OK. The confirmation message displays. 2. Use ◀/▶ to select Reset and press OK. The picture mode returns to the factory preset settings. 3. Repeat steps 1 and 2 if you want to reset other picture modes.
-----------------------------------	--

Audio Setup menu







Submenu	Functions and Descriptions
Sound Mode	<ul style="list-style-type: none"> • Effect Mode Selects a sound effect mode to your preference. The following preset sound modes are provided: Standard, Cinema, Music, Sport, and User. When selecting the User mode, you may make manual adjustments with the User EQ function.  If the Mute function is activated, adjusting Sound Mode will turn off the Mute function. • User EQ Selects desired frequency bands (100 Hz, 300 Hz, 1k Hz, 3k Hz, and 10k Hz) to adjust the levels according to your preference. The settings made here define the User mode.
Mute	<p>Selects On to temporarily turn off the projector's internal speaker or the volume being output from the audio output jack. To restore the audio, select Off.  The function is accessible through the remote control.</p>
Volume	<p>Adjusts the volume level of the projector's internal speaker or the volume being output from the audio output jack.  If the Mute function is activated, adjusting Mute will turn off the Mute function.  The function is accessible through the remote control.</p>
Power On/Off Ring Tone	<p>Sets the ring tone for the projector On or Off.  The Power On/Off Ring Tone can only be adjusted here. Setting the sound mute or adjusting the sound level do not affect the Power On/Off Ring Tone.</p>
Reset Audio Settings	<p>All of the adjustments you've done under the Audio Setup menu return to the factory preset values.</p>

Display menu



Submenu	Functions and Descriptions
<p>Aspect Ratio</p>	<p>The native display resolution of this projector is in a 16:9 aspect ratio. However, you may use this function to display projected picture of different aspect ratio.</p> <p> In the following illustrations, the black portions are inactive areas and the white portions are active areas.</p> <ul style="list-style-type: none"> • Auto  Scales a picture proportionally to fit the projector's native resolution in its horizontal or vertical width. This makes the most use of the screen and maintains the aspect ratio of a picture. • 4:3  Scales the picture so that it is displayed in the center of the screen with a 4:3 aspect ratio. • 16:9  Scales a picture so that it is displayed in the center of the screen with a 16:9 aspect ratio. • Wide  Stretches a picture in a horizontal direction to fit the screen width. It does not alter the height of a picture. • Letter Box  Scales a picture to fit the projector's native resolution in its horizontal width and resizes the picture height to the 3/4 of the projection width. This makes a picture greater than the screen height. The top and bottom edges of the displayed picture are cropped. This suits the contents which are produced in letter box format (with black bars on the top and bottom).  Letter Box format picture
<p>Image Position</p>	<p>Displays the Image Position window. You may use the directional arrow keys on the projector or remote control to adjust the position of the projected picture.</p> <p>The values shown on the lower position of the window change with every key press you made.</p> <p> This function is only available when the PC signal is selected.</p>
<p>Overscan Adjustment</p>	<p>Conceals the poor picture quality in the four edges.</p> <p>The greater the value, the more portion of the picture is concealed while the screen remains filled and geometrically accurate. Setting 0 means the picture is 100% displayed.</p>







<p>PC & Component YPbPr Tuning</p>	<ul style="list-style-type: none"> • H. Size Adjusts the horizontal width of the picture.  This function is only available when the Component or PC signal is selected. • Phase Adjusts the clock phase to reduce picture distortion.  This function is only available when the Component or PC signal is selected. • Auto Adjusts the phase and frequency automatically.  This function is only available when the PC signal is selected.
<p>3D</p>	<p>This projector supports playing three-dimensional (3D) content transferred through your 3D-compatible video devices and contents, such as PlayStation consoles (with 3D game discs), 3D Blu-ray 3D players (with 3D Blu-ray discs), 3D TV (with 3D channel), and so on. After you have connected the 3D video devices to the projector, wear the BenQ 3D glasses and make sure the power is on to view 3D contents.</p> <p> When watching 3D contents,</p> <ul style="list-style-type: none"> • the image may seem misplaced, however, this is not a product malfunction. • take appropriate breaks when watching 3D content. • stop watching 3D content if you feel fatigue or discomfort. • keep a distance from the screen of about three times the effective height of the screen when watching 3D content. • children and people with a history of oversensitivity to light, heart problems, or have any other existing medical condition should be refrained from watching 3D content. <p>The following functions help enhance your 3D viewing experience.</p> <ul style="list-style-type: none"> • 3D Mode The default setting is Auto and the projector automatically chooses an appropriate 3D format when detecting 3D contents. If the projector cannot recognize the 3D format, manually choose a 3D mode according to your preference.  When this function is enabled: <ul style="list-style-type: none"> • the brightness level of the projected image decreases. • the Picture Mode cannot be adjusted. • the 2D Keystone can only be adjusted within limited degrees. • 3D Sync Invert When your 3D image is distorted, enable this function to switch between the image for the left eye and the right eye for the more comfortable 3D viewing experience.  These functions are accessible through the remote control.

System Setup : Basic menu

Submenu	Functions and Descriptions
Language	Sets the language for the On-Screen Display (OSD) menus.
Background Color	Sets the background color when there is no signal to the projector.
Splash Screen	Allows you to select which logo screen displays during projector start-up. You can choose BenQ logo screen, Blue screen, or Black screen.
Projector Position	The projector can be installed on a ceiling or behind a screen, or with one or more mirrors. See Choosing a location for details.
Auto Off	Prevents unnecessary projection when no signal is detected for a long time. See Setting Auto Off for details.
Direct Power On	When the function is set to On , the projector will be turned on automatically once the power is fed through the power cable. When the function is set to Off , you'll have to turn on the projector by pressing  on the projector or  on the remote control.
Menu Settings	<ul style="list-style-type: none"> • Menu Type Switches to the Basic OSD menu. • Menu Display Time Sets the length of time the OSD will remain active after your last key press. • Blank Reminder Message Sets whether the reminder message is displayed by the projector while the image is hidden.
Source Rename	<p>Renames the current input source to your desired name.</p> <p>On the Source Rename window, use /// to set the desired characters for the connected source item. When done, press OK to save the changes.</p>
Auto Source	<p>Sets whether the projector searches automatically for input sources.</p> <p>Select On to enable the projector to scan for input sources until it acquires a signal. If the function is set to Off, the projector will select the last used input source.</p>

System Setup : Advanced menu

Submenu	Functions and Descriptions
Reset Lamp Timer	Activates this function only after a new lamp is installed. When you select Reset , a " Reset Successfully " message displays to notify that the lamp time has been reset to "0".
HDMI Settings	<ul style="list-style-type: none"> • HDMI Format Selects an input source type for the HDMI signal. You can also manually select the source type. Different source types carry different standards for the brightness level.  HDMI Format is only available when the HDMI signal is selected. • CEC When you connect an HDMI CEC-compatible device to your projector with an HDMI cable, turning on the HDMI CEC compatible device automatically turns on the projector, while turning off the projector automatically turns off the HDMI CEC compatible device.
Baud Rate	Selects a baud rate that is identical with your computer's so that you can connect the projector with a suitable RS-232 cable and update or download the projector's firmware. This function is intended for qualified service personnel.
Test Pattern	Enables this function to display the grid test pattern, which helps you adjust the image size and focus so as to check if the projected image is free of distortion.
Closed Caption	<ul style="list-style-type: none"> • Closed Caption Enable Activates the function by selecting On when the selected input signal carries closed captions*. *About caption An on-screen display of the dialogue, narration, and sound effects of TV programs and videos that are closed captioned (usually marked as "CC" in TV listings). • Caption Version Selects a preferred closed captioning mode. To view captions, select CC1, CC2, CC3, or CC4 (CC1 displays captions in the primary language in your area).
Quick Cooling	Selects On to shorten the projector cooling time from a normal 90-second duration to approximately 15 seconds.
High Altitude Mode	<p>It is a mode for operation in areas like high altitude or high temperature. Activate the function when your environment is between 1500 m –3000 m above sea level and ambient temperature is between 0°C–30°C.</p> <p> Do not use this function if your altitude is between 0 m and 1500 m and ambient temperature is between 0°C and 35°C. If you turn on the mode under such a condition, the projector will be over cooled.</p> <p>Operation under High Altitude Mode may cause a higher decibel operating noise level because of increased fan speed necessary to improve overall system cooling and performance.</p> <p>If you use this projector under other extreme conditions excluding the above, it may display auto shut-down symptoms, which is designed to protect your projector from over-heating. In cases like this, you should switch to High Altitude Mode to solve these symptoms. However, this is not to state that this projector can operate under any and all harsh or extreme conditions.</p>

<p>Password</p>	<p>For security purposes and to prevent unauthorized use, you may set up password security for the projector. See Utilizing the password function for details.</p> <ul style="list-style-type: none"> • Change Password You will be asked to enter the current password before changing to a new one. • Power On Lock Limits use of the projector to only those who know the correct password.
<p>Key Lock</p>	<p>With the control keys on the projector locked, you can prevent your projector settings from being changed accidentally (by children, for example). When you select On to enable this function, no control keys on the projector will operate, except  POWER. To unlock the keys, press and hold  on the projector for 3 seconds.</p>
<p>LED Indicator</p>	<p>When you select On, all LED indicators on the projector function normally. See Indicators for more details. When you select Off, the LED indicators (, , ) are off after you turn on the projector and the splash screen displays. However, if the projector is not working properly, the LED indicators light or flash to remind you that a problem may occur. See also Indicators for more details.</p>
<p>Reset All Settings</p>	<p>Returns all settings to the factory preset values. The OSD menu type will return to the Basic OSD menu.</p> <p> The following settings will still remain: Keystone, Language, Projector Position, Reset Lamp Timer, High Altitude Mode, Password, Key Lock, and ISF.</p>
<p>ISF</p>	<p>The ISF calibration menu is password protected and only accessible by authorized ISF calibrators. The ISF (Imaging Science Foundation) has developed carefully crafted, industry-recognized standards for optimal video performance and has implemented a training program for technicians and installers to use these standards to obtain optimal picture quality from BenQ video display devices. Accordingly, we recommend that setup and calibration be performed by an ISF certified installation technician.</p> <p> For more information, go to www.imagingscience.com or contact the dealer or retailer from whom you purchased the projector.</p>

Information menu

Submenu	Functions and Descriptions
Source	Displays the current signal source.
Picture Mode	Displays the current picture mode under the Picture menu.
Resolution	Displays the native resolution of the input source.
Color System	Displays input system format.
Equivalent Lamp Hour	Displays the number of hours the lamp has been used.
3D Format	Displays the current 3D mode. Only available when 3D Mode is enabled.
Firmware Version	Displays the firmware version of your projector.

 Some information is given only when certain input sources are in use.

Advanced OSD menu structure

The OSD menus vary according to the signal type selected.

Main menu	Submenu	Options	
Picture	Picture Mode	Cinema/Bright/Standard/User 1/User 2/3D/ISF Night/ISF Day	
	User Mode Management	Load Settings From Rename User Mode	
	Brightness	0-100	
	Contrast	0-100	
	Color	0-100	
	Tint	0-100	
	Sharpness	0-15	
	Color Temperature	Normal/Cool/Lamp Native/Warm	
	Lamp Power	Normal/Economic/SmartEco	
		Black Level	0 IRE/7.5 IRE
		Gamma Selection	1.6/1.8/2.0/2.2/2.4/2.5/2.6/2.8/BenQ
		Brilliant Color	On/Off
	Advanced...	Color Temperature Fine Tuning	Red Gain/Green Gain/Blue Gain/Red Offset/ Green Offset/Blue Offset
		Color Management	Primary Color/Hue/Gain/Saturation
		Noise Reduction	0-31
	Film Mode	On/Off	
	Reset Current Picture Mode	Reset/Cancel	
Audio Setup	Sound Mode	Effect Mode Standard/Cinema/Music/Sport/User User EQ 100 Hz/300 Hz/1k Hz/3k Hz/10k Hz	
	Mute	On/Off	
	Volume	0-10	
	Power On/Off Ring Tone	On/Off	
	Reset Audio Settings	Reset/Cancel	
	Aspect Ratio	Auto/4:3/16:9/Wide/Letter Box	
Display	Image Position		
	Overscan Adjustment	0/1/2/3	
	PC & Component YPbPr Tuning	H. Size	
		Phase	
		Auto	
	3D	3D Mode	Auto/3D Off/Frame Sequential/Frame Packing/Top-Bottom/Side-by-Side
3D Sync Invert		Invert	

System Setup : Basic	Language	English / Français / Deutsch Italiano / Español / Русский 繁體中文 / 简体中文 / 日本語 / 한국어 / Svenska / Nederlands / Türkçe / Čeština / Português / हिन्दी / Polski Magyar / Hrvatski / Română / Norsk / Dansk / Български / Suomi / Indonesian / Ελληνικά / العربية / हिन्दी	
	Background Color	Black/Blue/Purple	
	Splash Screen	BenQ/Black/Blue	
	Projector Position	Front/Front Ceiling/Rear/Rear Ceiling	
	Auto Off	Disable/5 min/10 min/15 min/20 min/25 min/ 30 min	
	Direct Power On	On/Off	
	Menu Settings	Menu Type	Basic/Advanced
		Menu Display Time	5 sec/10 sec/15 sec/20 sec/25 sec/30 sec/ Always On
		Blank Reminder Message	On/Off
	Source Rename		
	Auto Source	On/Off	
	System Setup : Advanced	Reset Lamp Timer	Reset/Cancel
		HDMI Settings	HDMI Format
CEC			On/Off
Baud Rate		2400/4800/9600/14400/19200/38400/57600/ 115200	
Test Pattern		On/Off	
Closed Caption		Closed Caption Enable	On/Off
		Caption Version	CC1/CC2/CC3/CC4
Quick Cooling		On/Off	
High Altitude Mode		On/Off	
Password		Change Password	
		Power On Lock	On/Off (input current password)
Key Lock		On/Off	
LED Indicator		On/Off	
Reset All Settings	Reset/Cancel		
ISF	(input password)		
Information	Source		
	Picture Mode		
	Resolution		
	Color System		
	Equivalent Lamp Hour		
	3D Format		
	Firmware Version		

Maintenance

Care of the projector

Your projector needs little maintenance. The only thing you have to do on a regular basis is keep the lens clean.

Never remove any parts of the projector except the lamp. Contact your dealer or local customer service center if the projector fails to operate as expected.

Cleaning the lens

Clean the lens whenever you notice dirt or dust on the surface.

Before cleaning any part of the projector, turn it off using the proper shutdown procedure (see [Shutting down the projector](#)), unplug the power cable, and let it cool down completely.

- Use a canister of compressed air to remove dust.
- If there is dirt or smears, use lens-cleaning paper or moisten a soft cloth with lens cleaner and gently wipe the lens surface.
- Never use any type of abrasive pad, alkaline/acid cleaner, scouring powder, or volatile solvent, such as alcohol, benzene, thinner or insecticide. Using such materials or maintaining prolonged contact with rubber or vinyl materials may result in damage to the projector surface and cabinet material.

 **Never touch the lens with your finger or rub the lens with abrasive materials. Even paper towels can damage the lens coating. Only ever use a proper photographic lens brush, cloth, and cleaning solution. Do not attempt to clean the lens while the projector is switched on or is still hot from previous use.**

Cleaning the projector case

Before cleaning any part of the projector, turn it off using the proper shutdown procedure (see [Shutting down the projector](#)), unplug the power cable, and let it cool down completely.

- To remove dirt or dust, wipe the case with a soft, dry, lint-free cloth.
- To remove stubborn dirt or stains, moisten a soft cloth with water and a neutral detergent. Then wipe the case.

 **Never use wax, alcohol, benzene, thinner or other chemical detergents. These can damage the case.**

Storing the projector

To store the projector for an extended time:

- Make sure the temperature and humidity of the storage area are within the recommended range for the projector. Refer to [Specifications](#) or consult your dealer about the range.
- Retract the adjuster feet.
- Remove the batteries from the remote control.
- Pack the projector in its original packing or equivalent.

Transporting the projector

It is recommended that you ship the projector with its original packing or equivalent.

Lamp information

Getting to know the lamp hour

When the projector is in operation, the duration (in hours) of lamp usage is automatically calculated by the built-in timer.

To obtain the lamp hour information:

1. Press **MENU** and then use the arrow keys (◀/▶/▲/▼) to go to **Information** or **Settings > Information**.
2. The **Equivalent Lamp Hour** information displays.
3. Press **BACK** to exit.

Extending lamp life

The projection lamp is a consumable item. To keep the lamp life as long as possible, you can do the following settings via the **Advanced** OSD menu.

To access the **Advanced** OSD menu, see 30 for details.

Setting Lamp Power

Setting the projector in **Economic** or **SmartEco** mode extends the lamp life.

Lamp mode	Description
Normal	100% lamp brightness
Economic	Saves 30% lamp power consumption
SmartEco	Saves up to 70% lamp power consumption depending on the content brightness level

Using **Economic** mode reduces system noise and power consumption by 30%. Using **SmartEco** mode reduces system noise and lamp power consumption by up to 70%. If the **Economic** or **SmartEco** mode is selected, the light output will be reduced and result in darker projected pictures.

1. Go to **Picture > Lamp Power**.
2. Press to **OK** display the **Lamp Power** window.
3. Press ◀/▶ to move to your desired mode, and press **OK**.
4. When done, press **BACK** to save your changes and exit.

Setting Auto Off

This function allows the projector to turn off automatically if no input source is detected after a set period of time.

1. Go to **System Setup : Basic > Auto Off**.
2. Press ◀/▶ to select a time period. If the preset time lengths are not suitable for your presentation, select **Disable**, and the projector will not automatically shut down in a certain time period.
3. When done, press **BACK** to save your changes and exit.



Timing of replacing the lamp

When the Lamp indicator lights up red or a message appears suggesting it is time to replace the lamp, please install a new lamp or consult your dealer. An old lamp may cause a malfunction in the projector and in some instances the lamp may explode. Go to <http://www.BenQ.com> for a replacement lamp.

The Lamp indicator light and Temperature warning light will light up if the lamp becomes too hot. Turn the power off and let the projector cool for 45 minutes. If the Lamp or Temp indicator still lights up after turning the power back on, please contact your dealer. See [Indicators](#) for details.

Please replace the lamp when the following lamp warning messages appear.

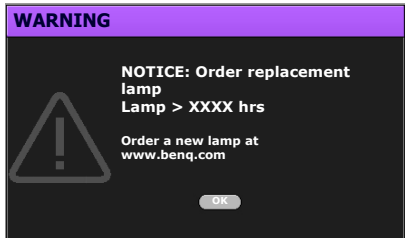
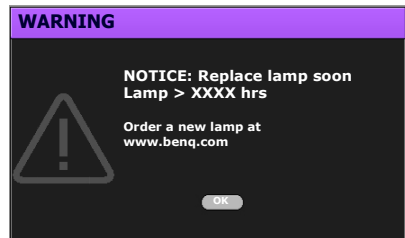
 The illustrations show the examples of messages you will see under the Advanced menu. They are for reference only and may differ from the actual design and the menu type you've selected.

Status	Message
<p>Install a new lamp for optimal performance. If the projector operates normally in Economic mode (see Getting to know the lamp hour), you may continue operating the projector until the next hour lamp warning appears.</p> <p>Press OK to dismiss the message.</p>	
<p>We strongly recommend you to replace the lamp at this stage. The lamp is a consumable item. The lamp brightness diminishes with use. This is normal lamp behavior. You can replace the lamp whenever you notice that the brightness level has significantly diminished.</p> <p>Press OK to dismiss the message.</p>	
<p>The lamp MUST be replaced before the projector will operate normally.</p> <p>Press OK to dismiss the message.</p>	

 "XXXX" shown in the above messages are numbers that vary depending on different models.

Replacing the lamp

- ⚠ • To reduce the risk of electrical shock, always turn the projector off and disconnect the power cable before changing the lamp.
- To reduce the risk of severe burns, allow the projector to cool for at least 45 minutes before replacing the lamp.
- To reduce the risk of injuries to fingers and damage to internal components, use caution when removing lamp glass that has shattered into sharp pieces.
- To reduce the risk of injuries to fingers and/or compromising image quality by touching the lens, do not touch the empty lamp compartment when the lamp is removed.
- This lamp contains mercury. Consult your local hazardous waste regulations to dispose of this lamp in a proper manner.
- To assure optimal performance from the projector, it is recommended that you purchase a qualified projector lamp for lamp replacement.
- If lamp replacement is performed while the projector is suspended upside-down from the ceiling, make sure that no one is underneath the lamp socket to avoid any possible injury or damage to the human eyes caused by fractured lamp.
- Ensure good ventilation when handling broken lamps. We recommend that you use respirators, safety glasses, goggles or face shield and wear protective clothing such as gloves.

1. Turn the power off and disconnect the projector from the power outlet. If the lamp is hot, avoid burns by waiting for approximately 45 minutes until the lamp has cooled.
2. Loosen the screw that secures the lamp cover on the side of the projector until the lamp cover loosens.

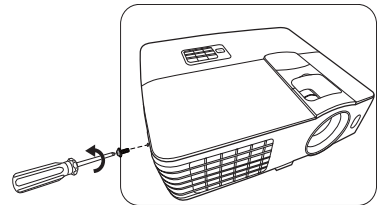

3. Remove the lamp cover from the projector.

- ⚠ • Do not turn the power on with the lamp cover removed.
- Do not insert your fingers between the lamp and the projector as the sharp edges inside the projector may cause injuries.

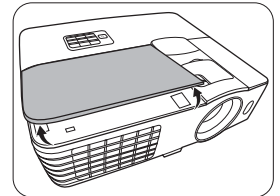

4. Loosen the screw that secures the lamp.
5. Lift the handle so that it stands up.

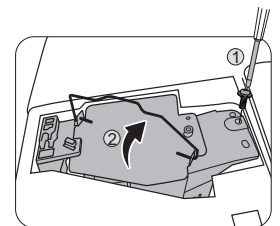

6. Use the handle to slowly pull the lamp out of the projector.

- ⚠ • Pulling it too quickly may cause the lamp to break and scatter broken glass in the projector.
- Do not place the lamp in locations where water might splash on it, children can reach it, or near flammable materials.
- Do not insert your hands into the projector after the lamp is removed. If you touch the optical components inside, it could cause color unevenness and distortion of the projected images.

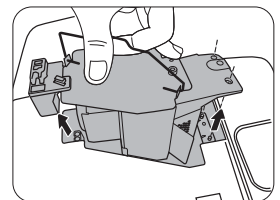

7. As shown in the illustration, lower the new lamp.

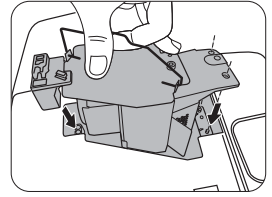

8. Tighten the screw that secures the lamp.

9. Ensure the handle is fully laid flat and locked in place.



- **Loose screw may cause a bad connection, which could result in malfunction.**
- **Do not over tighten the screw.**

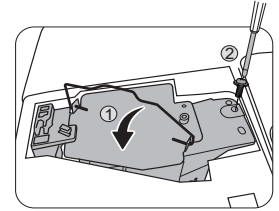

10. Replace the lamp cover on the projector.

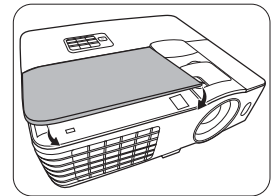

11. Tighten the screw that secures the lamp cover.



- **Loose screw may cause a bad connection, which could result in malfunction.**
- **Do not over tighten the screw.**

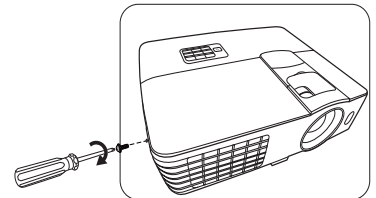

12. Connect the power and restart the projector.

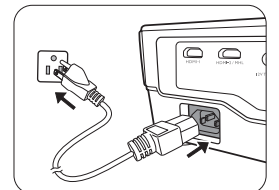

13. After the startup logo displays, resetting the lamp timer via the OSD menu.

- Under the **Advanced** OSD menu, go to **System Setup : Advanced > Reset Lamp Timer**, and select **Reset**.
- Under the **Basic** OSD menu, if there's no signal connected to the projector, go to **Reset Lamp Timer** and select **Reset**; if there are signals connected, go to **Settings > Reset Lamp Timer**, and select **Reset**.





Do not reset if the lamp is not new or replaced as this could cause damage.

A "**Reset Successfully**" message displays to notify that the lamp time has been reset to "0".



Indicators

There are three indicators which show the status of the projector. Check the following information about the indicator lights. If there is anything wrong, turn the projector off and contact your dealer.

- **When the projector is in a normal state**

POWER 	TEMP 	LAMP 	Status & Description
Orange	Off	Off	Stand-by mode
Green Flashing	Off	Off	Powering up
Green	Off	Off	Normal operation
Orange Flashing	Off	Off	<ul style="list-style-type: none"> • The projector needs 90 seconds to cool down as it was abnormally shut down without the normal cooling down process. • The projector needs to cool for 90 seconds after the power is turned off.

- **When the projector is in an abnormal state**

POWER 	TEMP 	LAMP 	Status & Description
Off	Off	Red	<ul style="list-style-type: none"> • The lamp has been damaged. Please contact your local BenQ customer center for purchasing a new lamp.
Off	Off	Red Flashing	<ul style="list-style-type: none"> • The lamp is not properly attached. • The lamp has been damaged. Please contact your local BenQ customer center for purchasing a new lamp.
Off	Off	Orange Flashing	The lamp is not lit up.
Green	Off	Orange	The lamp life exhausted. Please contact your local BenQ customer center for purchasing a new lamp.
Red	Red	Off	The fans are not working. The projector has shut down automatically. If you try to restart the projector, it will shut down again. Please contact your dealer for assistance.
Red	Red Flashing	Off	
Red	Green	Off	
Red	Green Flashing	Off	
Green	Red	Off	The internal temperature is too high. <ul style="list-style-type: none"> • The intake ventilation or the exhaust ventilation is blocked. • The projector may be in a poorly ventilated location. • The ambient temperature may be too high.

Troubleshooting

Problem	Cause	Remedy
The projector does not turn on.	There is no power from the power cable.	Plug the power cable into the AC inlet on the rear of the projector, and plug the power cable into to the power outlet. If the power outlet has a switch, make sure that it is switched on.
	Attempting to turn the projector on again during the cooling process.	Wait until the cooling down process has completed.
	The lamp cover is not securely attached.	Correctly attach the lamp cover.
No picture.	The video source is not turned on or connected correctly.	Turn the video source on and check that the signal cable is connected correctly.
	The projector is not correctly connected to the input source device.	Check the connection.
	The input source has not been correctly selected.	Select the correct source with the SOURCE key on the projector or remote control.
Image is unstable.	The connection cables are not securely connected to the projector or the signal source.	Correctly connect the cables to the appropriate terminals.
Picture is blurred.	The projection lens is not correctly focused.	Adjust the focus of the lens using the focus ring.
	The projector and the screen are not aligned properly.	Adjust the projection angle and direction as well as the height of this projector if necessary.
	The lens cover is still closed.	Remove the lens cover.
Remote control does not work correctly.	The batteries are out of power.	Replace both of the batteries with new ones.
	There is an obstacle between the remote control and the projector.	Remove the obstacle.
	You are too far away from the projector.	Stand within 8 meters (26.2 feet) of the projector.
3D content does not display correctly	The 3D glasses are out of battery.	Recharge the 3D glasses.
	The settings in the 3D menu are not set correctly.	Correctly set the settings in the 3D menu.
	Your Blu-ray Disc is not in 3D format.	Use a 3D Blu-ray Disc and try again.
	The input source has not been correctly selected.	Select the correct source with the SOURCE key on the projector or remote control.

Specifications

Projector specifications

 All specifications are subject to change without notice.

Optical

Resolution

1920 (H) x 1080 (V)

Display system

Single-chip DLP™ system

Lens F/Number

F = 2.59 to 2.87, f = 16.88 to 21.88 mm
(HT1075)

F = 2.6 to 2.78, f = 10.2 to 12.24 mm
(HT1085ST)

Lamp

240 W lamp

Electrical

Power supply

AC100–240V, 3.5 A, 50-60 Hz (Automatic)

Power consumption

375 W (Max); < 0.5 W (Standby)

Mechanical

Weight

2.75 Kg (6.06 lbs) (HT1075)

2.85 Kg (6.28 lbs) (HT1085ST)

Output terminals

Speaker

(Stereo) 10 watt x 1

Audio signal output

PC audio jack x 1

Control

RS-232 serial control

9 pin x 1

IR receiver x 2

12VDC (Max. 0.5 A) x 1

Input terminals

Computer input

RGB input

D-Sub 15-pin (female) x 1

Video signal input

VIDEO

RCA jack x 1

SD/HDTV signal input

Analog - Component RCA jack x 3
(through RGB input)

Digital - HDMI x 1

Digital - HDMI/MHL x 1

Audio signal input

Audio in

RCA audio jack (L/R) x 2

PC audio jack x 1

USB port (Type-A x 1; Mini-B x 1)

Environmental Requirements

Operating temperature

0°C–40°C at sea level

Operating relative humidity

10%–90% (without condensation)

Operating altitude

0–1499 m at 0°C–35°C

1500–3000 m at 0°C–30°C (with
High Altitude Mode on)

Dimensions

311.87 mm x 244.12 mm x 104 mm (W x D x H)

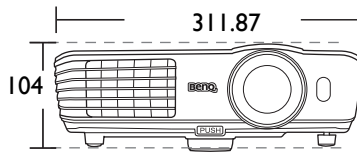
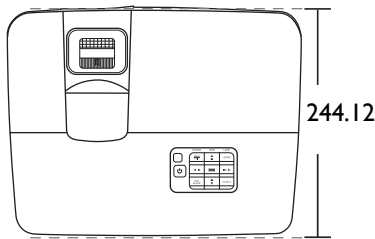

Unit: mm

Ceiling mount installation

- ⊙ Ceiling mount screws: M4
(Max. L = 25 mm; Min. L = 20 mm)

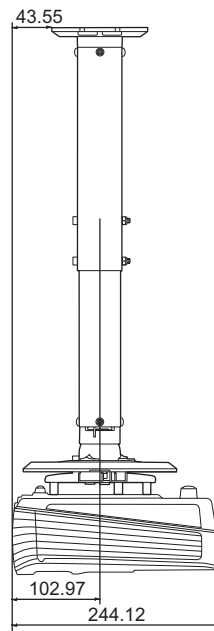
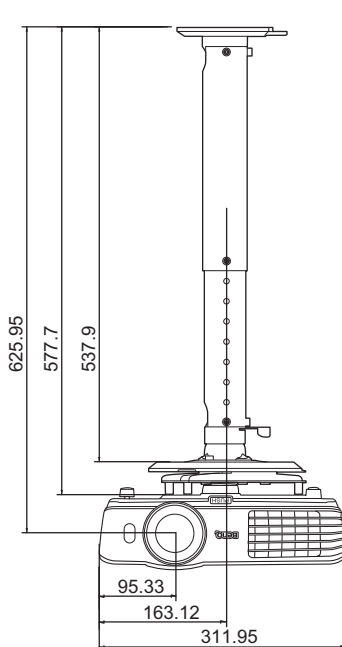
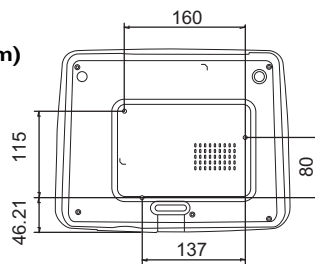

Unit: mm

Timing chart

Supported timing for PC input

Format	Resolution	Refresh rate (Hz)	H. Frequency (KHz)	Pixel Frequency (MHz)
720 x 400	720 x 400_70	70.087	31.469	28.3221
640 x 480	VGA_60*	59.940	31.469	25.175
	VGA_72	72.809	37.861	31.500
	VGA_75	75.000	37.500	31.500
	VGA_85	85.008	43.269	36.000
800 x 600	SVGA_60*	60.317	37.879	40.000
	SVGA_72	72.188	48.077	50.000
	SVGA_75	75.000	46.875	49.500
	SVGA_85	85.061	53.674	56.250
	SVGA_120** (Reduce Blanking)	119.854	77.425	83.000
1024 x 768	XGA_60*	60.004	48.363	65.000
	XGA_70	70.069	56.476	75.000
	XGA_75	75.029	60.023	78.750
	XGA_85	84.997	68.667	94.500
	XGA_120** (Reduce Blanking)	119.989	97.551	115.500
1152 x 864	1152 x 864_75	75.00	67.500	108.000
1024 x 576	BenQ Notebook Timing	60.0	35.820	46.966
1024 x 600	BenQ Notebook Timing	64.995	41.467	51.419
1280 x 720	1280 x 720_60*	60	45.000	74.250
1280 x 768	1280 x 768_60*	59.870	47.776	79.5
1280 x 800	WXGA_60*	59.810	49.702	83.500
	WXGA_75	74.934	62.795	106.500
	WXGA_85	84.880	71.554	122.500
	WXGA_120** (Reduce Blanking)	119.909	101.563	146.25

1280 x 1024	SXGA_60***	60.020	63.981	108.000
	SXGA_75	75.025	79.976	135.000
	SXGA_85	85.024	91.146	157.500
1280 x 960	1280 x 960_60***	60.000	60.000	108
	1280 x 960_85	85.002	85.938	148.500
1360 x 768	1360 x 768_60***	60.015	47.712	85.500
1440 x 900	WXGA+_60***	59.887	55.935	106.500
1400 x 1050	SXGA+_60***	59.978	65.317	121.750
1600 x 1200	UXGA***	60.000	75.000	162.000
1680 x 1050	1680 x 1050_60***	59.954	65.290	146.250
640 x 480@67Hz	MAC13	66.667	35.000	30.240
832 x 624@75Hz	MAC16	74.546	49.722	57.280
1024 x 768@75Hz	MAC19	74.93	60.241	80.000
1152 x 870@75Hz	MAC21	75.06	68.68	100.00

 *Supported timing for 3D signal with Frame Sequential, Top-Bottom and Side-by-Side format.

**Supported timing for 3D signal with Frame Sequential format.

***Supported timing for 3D signal with Top-Bottom and Side-by-Side format.

 The timings showing above may not be supported due to EDID file and VGA graphic card limitations. It is possible that some timings cannot be chosen.

Supported timing for HDMI (HDCP) input

Format	Resolution	Refresh rate (Hz)	H. Frequency (KHz)	Pixel Frequency (MHz)
640 x 480	VGA_60*	59.940	31.469	25.175
	VGA_72	72.809	37.861	31.500
	VGA_75	75.000	37.500	31.500
	VGA_85	85.008	43.269	36.000
720 x 400	720 x 400_70	70.087	31.469	28.3221
800 x 600	SVGA_60*	60.317	37.879	40.000
	SVGA_72	72.188	48.077	50.000
	SVGA_75	75.000	46.875	49.500
	SVGA_85	85.061	53.674	56.250
	SVGA_120** (Reduce Blanking)	119.854	77.425	83.000
1024 x 768	XGA_60*	60.004	48.363	65.000
	XGA_70	70.069	56.476	75.000
	XGA_75	75.029	60.023	78.750
	XGA_85	84.997	68.667	94.500
	XGA_120** (Reduce Blanking)	119.989	97.551	115.500
1152 x 864	1152 x 864_75	75.00	67.500	108.000
1024 x 576	BenQ Notebook Timing	60.00	35.820	46.996
1024 x 600	BenQ Notebook Timing	64.995	41.467	51.419
1280 x 720	1280 x 720_60*	60	45.000	74.250
1280 x 768	1280 x 768_60*	59.870	47.776	79.5
1280 x 800	WXGA_60*	59.810	49.702	83.500
	WXGA_75	74.934	62.795	106.500
	WXGA_85	84.880	71.554	122.500
	WXGA_120** (Reduce Blanking)	119.909	101.563	146.25
1280 x 1024	SXGA_60***	60.020	63.981	108.000
	SXGA_75	75.025	79.976	135.000
	SXGA_85	85.024	91.146	157.500

1280 x 960	1280 x 960_60***	60.000	60.000	108
	1280 x 960_85	85.002	85.938	148.500
1360 x 768	1360 x 768_60***	60.015	47.712	85.500
1440 x 900	WXGA+_60***	59.887	55.935	106.500
1400 x 1050	SXGA+_60***	59.978	65.317	121.750
1600 x 1200	UXGA***	60.000	75.000	162.000
1680 x 1050	1680 x 1050_60***	59.954	65.290	146.250
640x480@67Hz	MAC13	66.667	35.000	30.240
832x624@75Hz	MAC16	74.546	49.722	57.280
1024x768@75Hz	MAC19	75.020	60.241	80.000
1152x870@75Hz	MAC21	75.06	68.68	100.00

 *Supported timing for 3D signal with Frame Sequential, Top-Bottom and Side-by-Side format.

**Supported timing for 3D signal with Frame Sequential format.

***Supported timing for 3D signal with Top-Bottom and Side-by-Side format.

 The timings showing above may not be supported due to EDID file and VGA graphic card limitations. It is possible that some timings cannot be chosen.

Timing	Resolution	Vertical Frequency (Hz)	Horizontal Frequency (KHz)	Pixel Frequency (MHz)	Remark
480i***	720 (1440) x 480	59.94	15.73	27	HDMI only
480p***	720 x 480	59.94	31.47	27	HDMI only
576i	720 (1440) x 576	50	15.63	27	HDMI/DVI
576p	720 x 576	50	31.25	27	HDMI/DVI
720/50p**	1280 x 720	50	37.5	74.25	HDMI/DVI
720/60p*	1280 x 720	60	45.00	74.25	HDMI/DVI
1080/24P**	1920 x 1080	24	27	74.25	HDMI/DVI
1080/25P	1920 x 1080	25	28.13	74.25	HDMI/DVI
1080/30P	1920 x 1080	30	33.75	74.25	HDMI/DVI
1080/50i*****	1920 x 1080	50	28.13	74.25	HDMI/DVI
1080/60i*****	1920 x 1080	60	33.75	74.25	HDMI/DVI
1080/50P***	1920 x 1080	50	56.25	148.5	HDMI/DVI
1080/60P***	1920 x 1080	60	67.5	148.5	HDMI/DVI

 *Supported timing for 3D signal with Frame Packing, Top-Bottom format, Side-by-Side, and Frame Sequential format.

**Supported timing for 3D signal with Frame Packing, Top-Bottom format, and Side-by-Side format.

***Supported timing for 3D signal with Top-Bottom and Side-by-Side format.

****Supported timing for 3D signal with Frame Sequential format.

*****Supported timing for 3D signal with Side-by-Side format.

Supported timing for MHL input

Timing	Resolution	V. Frequency (Hz)	H. Frequency (KHz)	Pixel Freq. (MHz)	Remark
480i	720 (1440) × 480	59.94	15.73	27	MHL
480p	720 × 480	59.94	31.47	27	MHL
576i	720 (1440) × 576	50	15.63	27	MHL
576p	720 × 576	50	31.25	27	MHL
720/50p	1280 × 720	50	37.5	74.25	MHL
720/60p	1280 × 720	60	45.00	74.25	MHL
1080/50i	1920 × 1080	50	28.13	74.25	MHL
1080/60i	1920 × 1080	60	33.75	74.25	MHL
1080/24P	1920 × 1080	24	27	74.25	MHL
1080/25P	1920 × 1080	25	28.13	74.25	MHL
1080/30P	1920 × 1080	30	33.75	74.25	MHL

Supported timing for EDTV and HDTV (via Component inputs)

Format	Resolution	Refresh rate (Hz)	H. Freq. (KHz)	Pixel Freq. (MHz)
480i*	720 × 480	59.94	15.73	13.5
480p*	720 × 480	59.94	31.47	27
576i	720 × 576	50	15.63	13.5
576p	720 × 576	50	31.25	27
720/50p	1280 × 720	50	37.5	74.25
720/60p*	1280 × 720	60	45.00	74.25
1080/50i	1920 × 1080	50	28.13	74.25
1080/60i	1920 × 1080	60	33.75	74.25
1080/24P	1920 × 1080	24	27	74.25
1080/25P	1920 × 1080	25	28.13	74.25
1080/30P	1920 × 1080	30	33.75	74.25
1080/50P	1920 × 1080	50	56.25	148.5
1080/60P	1920 × 1080	60	67.5	148.5

 *Supported timing for 3D signal with Frame Sequential format.

Supported timing for Video input

Format	Resolution	Refresh rate (Hz)	H. Freq. (KHz)	Pixel Freq. (MHz)
NTSC*	-	60	15.73	3.58
PAL	-	50	15.63	4.43
SECAM	-	50	15.63	4.25/4.41
PAL-M	-	60	15.73	3.58
PAL-N	-	50	15.63	3.58
PAL-60	-	60	15.73	4.43
NTSC4.43	-	60	15.73	4.43

 *Supported timing for 3D signal with Frame Sequential format.

Warranty and Copyright information

Warranty

BenQ warrants this product against any defects in material and workmanship, under normal usage and storage.

Proof of purchase date will be required with any warranty claim. In the event this product is found to be defective within the warranty period, BenQ's only obligation and your exclusive remedy shall be replacement of any defective parts (labor included). To obtain warranty service, immediately notify the dealer from which you purchased the product of any defects.

Important: The above warranty shall be void if the customer fails to operate the product in accordance with BenQ's written instructions, especially the ambient humidity must be in-between 10% and 90%, temperature in-between 0°C and 35°C, altitude lower than 3000 meters, and avoiding to operate the projector in a dusty environment. This warranty gives you specific legal rights, and you may have other rights which vary from country to country.

For other information, please visit www.BenQ.com.

Copyright

Copyright © 2014 by BenQ Corporation. All rights reserved. No part of this publication may be reproduced, transmitted, transcribed, stored in a retrieval system or translated into any language or computer language, in any form or by any means, electronic, mechanical, magnetic, optical, chemical, manual or otherwise, without the prior written permission of BenQ Corporation.

All trademarks and registered trademarks are the property of their respective owners.

Disclaimer

BenQ Corporation makes no representations or warranties, either expressed or implied, with respect to the contents hereof and specifically disclaims any warranties, merchantability or fitness for any particular purpose. Further, BenQ Corporation reserves the right to revise this publication and to make changes from time to time in the contents hereof without obligation of BenQ Corporation to notify any person of such revision or changes.