



marantz®

Integrated Amplifier
PM5005

You can print more than one page of a PDF onto a single sheet of paper.

Owner's Manual

Front panel

Rear panel

Remote control
unit

Index



Accessories	4
Inserting the batteries	5
Operating range of the remote control unit	5
Features	6
High quality sound	6
High performance	6
Easy operation	7
Part names and functions	8
Front panel	8
Rear panel	10
Remote control unit	11

Connections

Connecting speakers	17
Speaker A/B connection	18
Bi-wiring connection	19
Connecting a playback device	20
Connecting a recording device	21
Connecting devices with remote control connectors	22
Performing operations by RC on this unit without visual contact	22
Remotely connecting Marantz audio devices	22
Connecting the power cord	23

Playback

Turning the power on	25
Selecting the speakers for audio output	26
Selecting the input source	26
Adjusting the volume	26
Turning off the sound temporarily (Muting)	26
Adjusting the tone	26
Playing CDs	27
Recording	28



Settings

Setting the Auto Standby mode	30
Turning Auto Standby mode on	30
Turning Auto Standby mode off	30
Setting the remote signal receiving function	31
Disabling the remote signal receiving function of the remote control unit	31
Enabling the remote signal receiving function of the remote control unit	31
Setting remote control codes	32
Setting remote control codes for the remote control	33
Setting remote control codes for this unit	33

Tips

Tips	35
Troubleshooting	36

Appendix

Explanation of terms	40
Specifications	41
Index	43





Thank you for purchasing this Marantz product.

To ensure proper operation, please read this owner's manual carefully before using the product.

After reading this manual, be sure to keep it for future reference.

Accessories

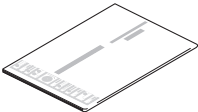
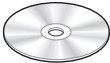
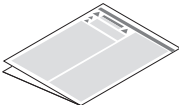
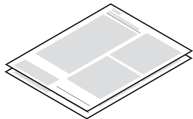
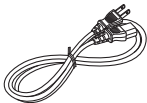
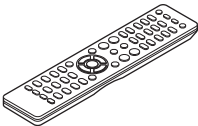
Check that the following parts are supplied with the product.

 <p>Quick Start Guide</p>	 <p>CD-ROM (Owner's Manual)</p>	 <p>Safety Instructions</p>	 <p>Warranty (for USA/for CANADA)</p>
 <p>Power cord</p>	 <p>Remote control unit (RC002PMCD)</p>	 <p>R03/AAA batteries</p>	



Inserting the batteries

- 1 Remove the rear lid in the direction of the arrow and remove it.

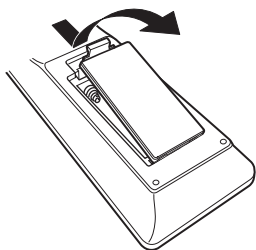

- 2 Insert two batteries correctly into the battery compartment as indicated.

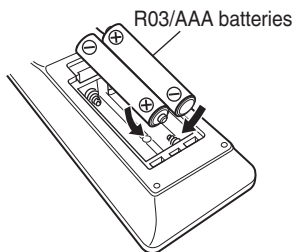

- 3 Put the rear cover back on.

NOTE

- To prevent damage or leakage of battery fluid:
 - Do not use a new battery together with an old one.
 - Do not use two different types of batteries.
- Remove the batteries from the remote control unit if it will not be in use for long periods.
- If the battery fluid should leak, carefully wipe the fluid off the inside of the battery compartment and insert new batteries.

Operating range of the remote control unit

Point the remote control unit at the remote sensor when operating it.

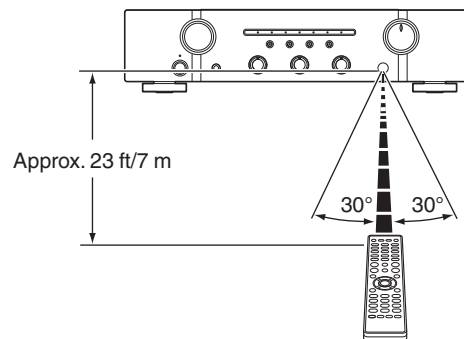

Features

High quality sound

- **All-discrete current feedback amplifier**

This unit uses a high-speed current feedback amplifier circuit for its preamplifier and power amplifier so that signals from the Super Audio CD player can be amplified with high fidelity. The high-speed current feedback amplifier reproduces a natural sound space.

- **High-power output**

This unit features a slimline body, but comes with a large power supply unit for dynamic music reproduction with high power.

- **High quality audio design**

This unit has a high quality audio design such as minimized signal path, use of high sound quality parts, and large power circuit, which is possible only in discrete audio components.

- **Phono input connectors for connecting turntables**

This unit is provided with a phono amplifier so that you can directly connect a turntable and play records (Only the MM cartridge can be used). (🔍 p. 20)

- **Two-sets of speaker output terminals**

In addition to using two sets of speakers (Speakers A and Speakers B), you can connect to bi-wiring speakers with separate input terminals for high range and low range. (🔍 p. 19)

The unit adopts screw terminals that can connect thick audio cables.

High performance

- **Tone control function**

This unit has a tone control function for adjustment of bass (low frequency) and treble (high frequency) sound to produce your preferred tone. (🔍 p. 27)

- **LOUDNESS function**

This unit is provided with a LOUDNESS function that makes it easier to hear music played back at a low volume level. (🔍 p. 27)



Easy operation

- **Remote control compatible with CD players and network audio players**

The remote control provided with this unit can control Marantz CD players and network audio players in addition to this unit. (☞ p. 12)
This unit can also switch between three remote control codes. When using three units in the same area, you can set a different remote control code for each unit to control them independently. (☞ p. 33)



Part names and functions

Front panel

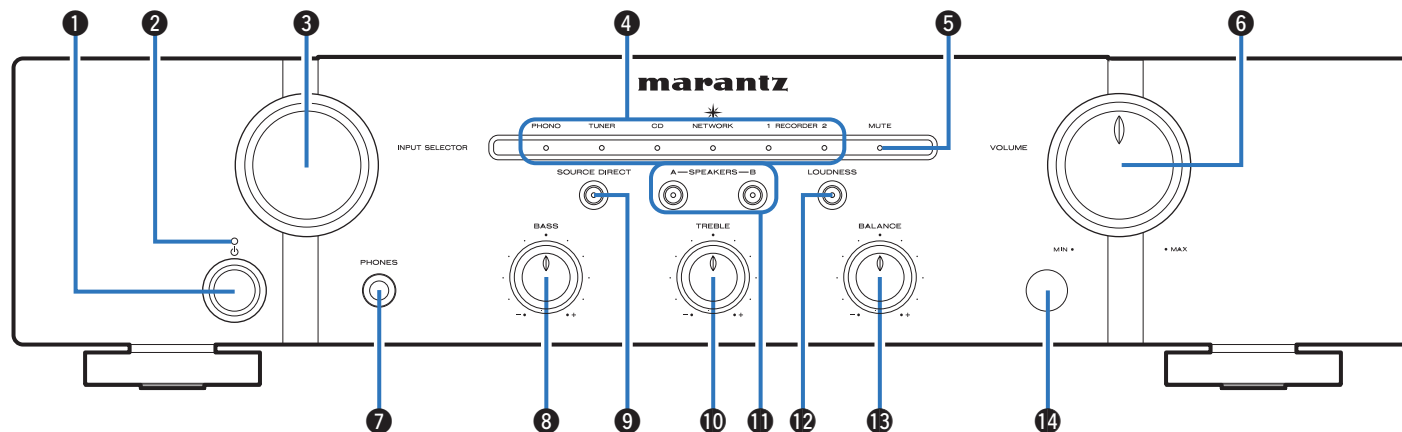

1 Power operation button (ϕ)

This turns the power on/off. (☞ p. 25)

2 Power indicator

This is lit as follows according to the power status:

- Power on : Off
- Standby : Red
- Power off : Off
- When the protection circuit is activated : Red (blinking)



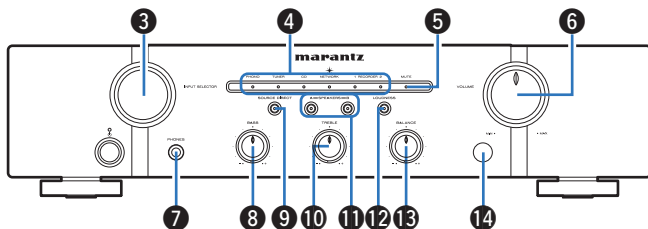

3 Input source select knob (INPUT SELECTOR)

This selects the input source. (☞ p. 26)

4 Input indicators (☞ p. 26)

5 MUTE indicator

This lights while the sound is muted. (☞ p. 26)

6 VOLUME knob

These adjust the volume level. (☞ p. 26)

7 Headphones jack (PHONES)

Used to connect headphones.

Turn off speaker output when using headphones. (☞ p. 26)

NOTE

To prevent hearing loss, do not raise the volume level excessively when using headphones.

8 BASS control knob

This setting adjusts the volume level for the bass. (☞ p. 26)

9 SOURCE DIRECT button/indicator

This turns SOURCE DIRECT mode on/off.

(☞ p. 27)

10 TREBLE control knob

This setting adjusts the volume level for the treble. (☞ p. 26)

11 Speaker switching buttons/indicators (SPEAKERS A/B)

These select the speaker for audio output. (☞ p. 26)

12 LOUDNESS button/indicator

This turns the LOUDNESS mode on/off.

(☞ p. 27)

13 BALANCE control knob

This adjusts the balance of the volume output from the left and right speakers. (☞ p. 26)

14 Remote control sensor

This receives signals from the remote control unit. (☞ p. 5)



8, 10, 12 and 13 can be adjusted when 9 is off (SOURCE DIRECT mode is off).



Rear panel

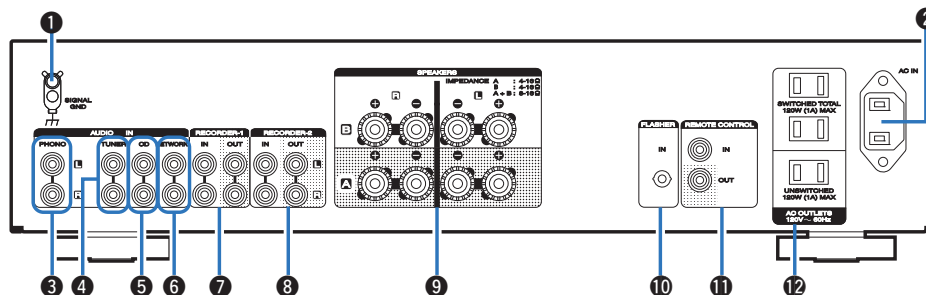

1 SIGNAL GND jacks

Used to connect a turntable. (☞ p. 20)

2 AC inlet (AC IN)

Used to connect the power cord. (☞ p. 23)

3 Turntable input connectors (PHONO)

Used to connect a turntable. (☞ p. 20)

4 Tuner input connectors (TUNER)

Used to connect a tuner. (☞ p. 20)

5 CD input connectors

Used to connect a CD player. (☞ p. 20)

6 Network audio player input connectors (NETWORK)

Used to connect a network audio player. (☞ p. 20)

7 Recorder input/output connectors (RECORDER 1)

Used to connect the input/output connector of a recorder. (☞ p. 21)

8 Recorder input/output connectors (RECORDER 2)

Used to connect the input/output connector of a recorder. (☞ p. 21)

9 Speaker terminals (SPEAKERS)

Used to connect speakers. (☞ p. 17)

10 FLASHER IN jack

Used when using a control BOX or other such control devices to control this unit.

11 Remote control input/output connectors (REMOTE CONTROL)

Used to connect to a Marantz audio device that is compatible with the remote control function. (☞ p. 22)

12 AC outlets (AC OUTLETS)

Used to connect the AC outlets of this unit in order to supply power to other AV equipment. (☞ p. 23)



Remote control unit

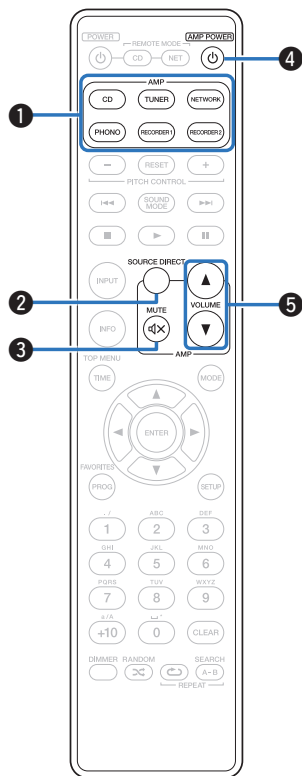

■ Amplifier operations

- 1 Input source select buttons**
 This selects the input source. (☞ p. 26)
- 2 SOURCE DIRECT button**
 This turns SOURCE DIRECT mode on/off. (☞ p. 27)
- 3 MUTE button (🔇)**
 This mutes the output audio. (☞ p. 26)
- 4 AMP POWER button (⏻)**
 This turns the power on/off (standby). (☞ p. 25)
- 5 VOLUME buttons (▲▼)**
 These adjust the volume level. (☞ p. 26)



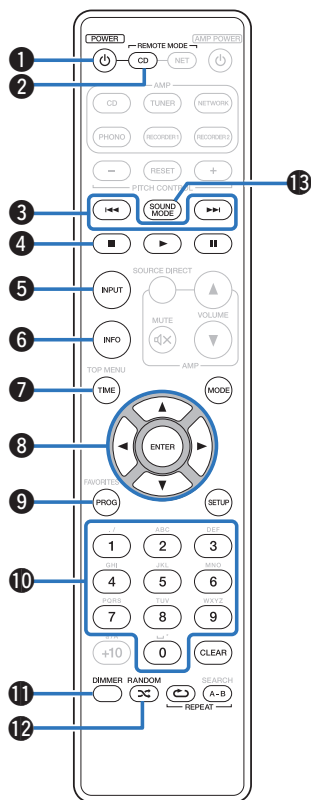

CD player operations

The supplied remote control can be used to control a Marantz CD player in addition to this unit. To operate a Marantz CD player, press the REMOTE MODE CD button to switch the remote control to the CD player operation mode.

- REMOTE MODE CD button lights for approximately two seconds.

- 1 POWER button (⏻)
- 2 Remote mode select button (REMOTE MODE CD)
- 3 Skip buttons (⏮, ⏭)
- 4 Stop button (■)
- 5 Input source select button (INPUT)
- 6 Information button (INFO)
- 7 TIME button
- 8 Cursor buttons (⬆, ⬇, ⬅, ➡)
- 9 Program button (PROG)
- 10 Number buttons (0 – 9)
- 11 DIMMER button
- 12 RANDOM button (🎲)
- 13 SOUND MODE button



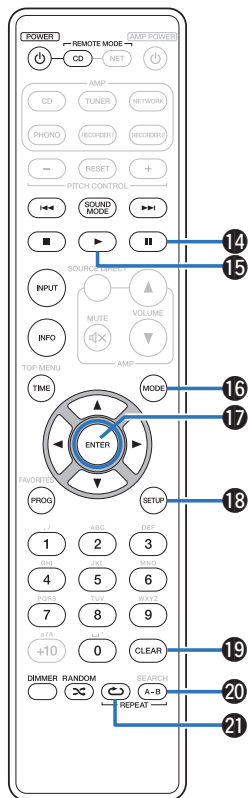

- 14 Pause button (⏸)
- 15 Play button (▶)
- 16 Playback mode switching button (MODE)
- 17 ENTER button
- 18 SETUP button
- 19 CLEAR button
- 20 REPEAT A-B button
- 21 REPEAT button (↺)



The amplifier can be operated with the amplifier operation buttons even when the remote control operation mode is set to CD.



■ Network audio player operations

The remote control provided with this unit can control a network audio player in addition to this unit. To operate a Marantz network audio player, press the REMOTE MODE NET button to switch the remote control to the network audio player operation mode.

- REMOTE MODE NET button lights for approximately two seconds.

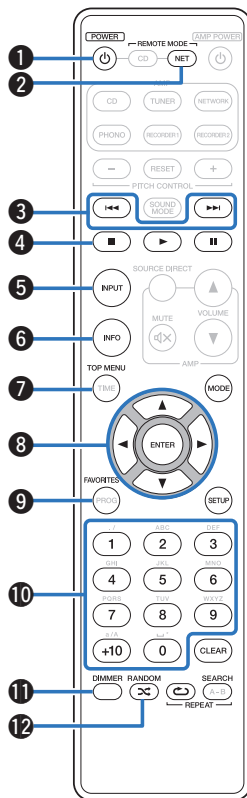

- 1 POWER button (⏻)
- 2 Remote mode select button (REMOTE MODE NET)
- 3 Skip buttons (⏮, ⏭)
- 4 Stop button (■)
- 5 Input source select button (INPUT)
- 6 Information button (INFO)
- 7 TOP MENU button
- 8 Cursor buttons (⬆, ⬇, ⬅, ➡)
- 9 FAVORITES button
- 10 Number buttons (0 – 9, +10)
- 11 DIMMER button
- 12 RANDOM button (🎲)



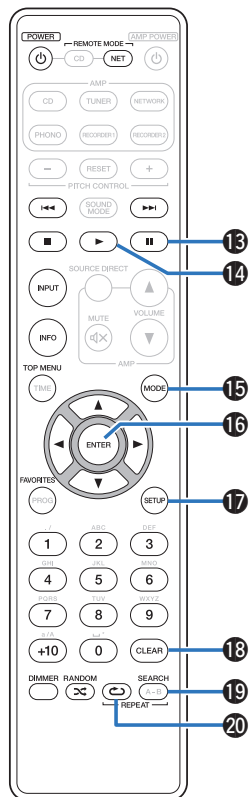

13 Pause button (II)

14 Play button (▶)

15 Playback mode switching button (MODE)

16 ENTER button

17 SETUP button

18 CLEAR button

19 Search button (SEARCH)

20 REPEAT button (↺)



The amplifier can be operated with the amplifier operation buttons even when the remote control mode is NET.



■ Contents

Connecting speakers	17
Connecting a playback device	20
Connecting a recording device	21
Connecting devices with remote control connectors	22
Connecting the power cord	23

NOTE

- Do not plug in the power cord until all connections have been completed.
- Do not bundle power cords together with connection cables. Doing so can result in humming or noise.

■ Cables used for connections

Provide necessary cables according to the devices you want to connect.

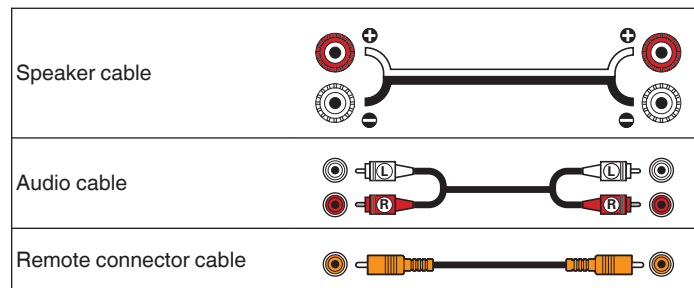

Connecting speakers

NOTE

- Disconnect this unit's power plug from the power outlet before connecting the speakers.
- Connect so that the speaker cable core wires do not protrude from the speaker terminal. The protection circuit may be activated if the core wires touch the rear panel or if the + and - sides touch each other. ("Protection circuit" (☞ p. 40))
- Never touch the speaker terminals while the power cord is connected. Doing so could result in electric shock.
- Use speakers with impedances within the ranges shown below to suit how they are used.

Speaker terminals used on this unit	No. of connected speakers	Speaker Impedance
SPEAKERS A (Standard connection)	2 (one set)	4 – 16 Ω/ohms
SPEAKERS B	2 (one set)	4 – 16 Ω/ohms
SPEAKERS A and SPEAKERS B	4 (two sets)	8 – 16 Ω/ohms
SPEAKERS A and SPEAKERS B (Bi-wiring connection)	2 (one set)	4 – 16 Ω/ohms

■ Connecting the speaker cables

Carefully check the left (L) and right (R) channels and + (red) and – (black) polarities on the speakers being connected to this unit, and be sure to connect the channels and polarities correctly.

- 1 Peel off about 3/8 inch (10 mm) of sheathing from the tip of the speaker cable, then either twist the core wire tightly or terminate it.**



- 2 Turn the speaker terminal counterclockwise to loosen it.**



- 3 Insert the speaker cable's core wire to the hilt into the speaker terminal.**



- 4 Turn the speaker terminal clockwise to tighten it.**



Speaker A/B connection

This unit is equipped with two sets of speaker terminals (SPEAKER A and SPEAKER B). One set of speakers can be connected to each set of terminals, and a total of two sets of speakers can be connected.

The same signal is output from the SPEAKERS A and SPEAKERS B terminals.

When only one set of speakers is to be connected, use either the SPEAKERS A or SPEAKERS B terminals.

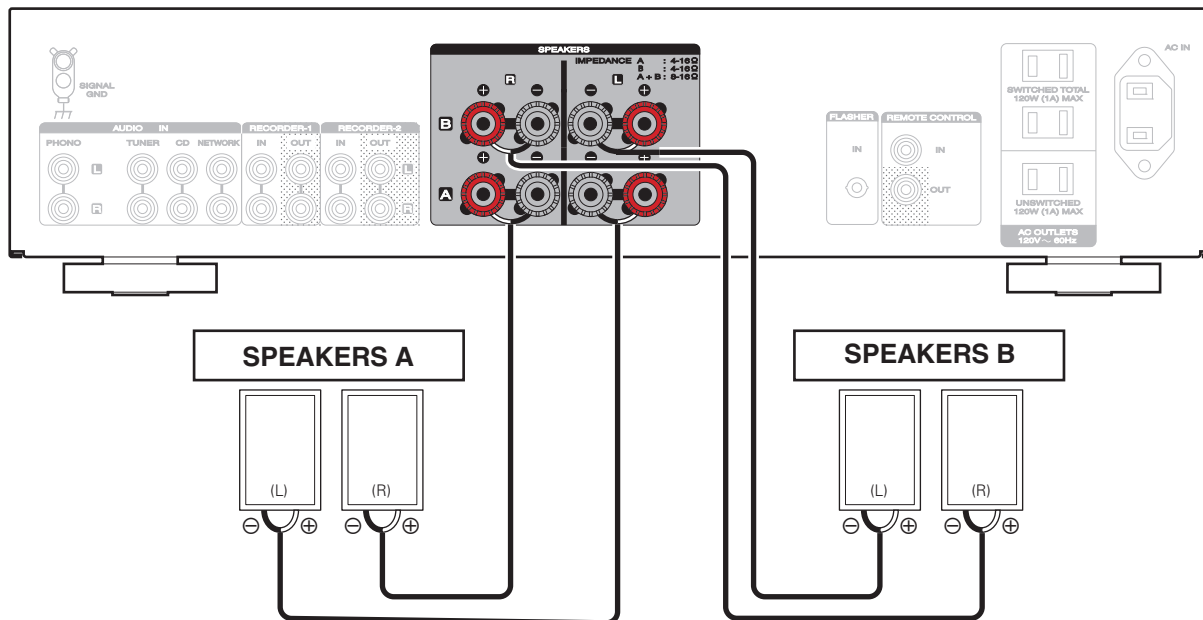

Bi-wiring connection

This connection limits the effects of signal interference between the high range speakers (tweeters) and low range speakers (woofers), allowing you to enjoy high quality playback.

When bi-wiring with bi-wireable speakers, connect the mid and high range terminals to SPEAKERS A (or SPEAKERS B), the low range terminals to SPEAKERS B (or SPEAKERS A).

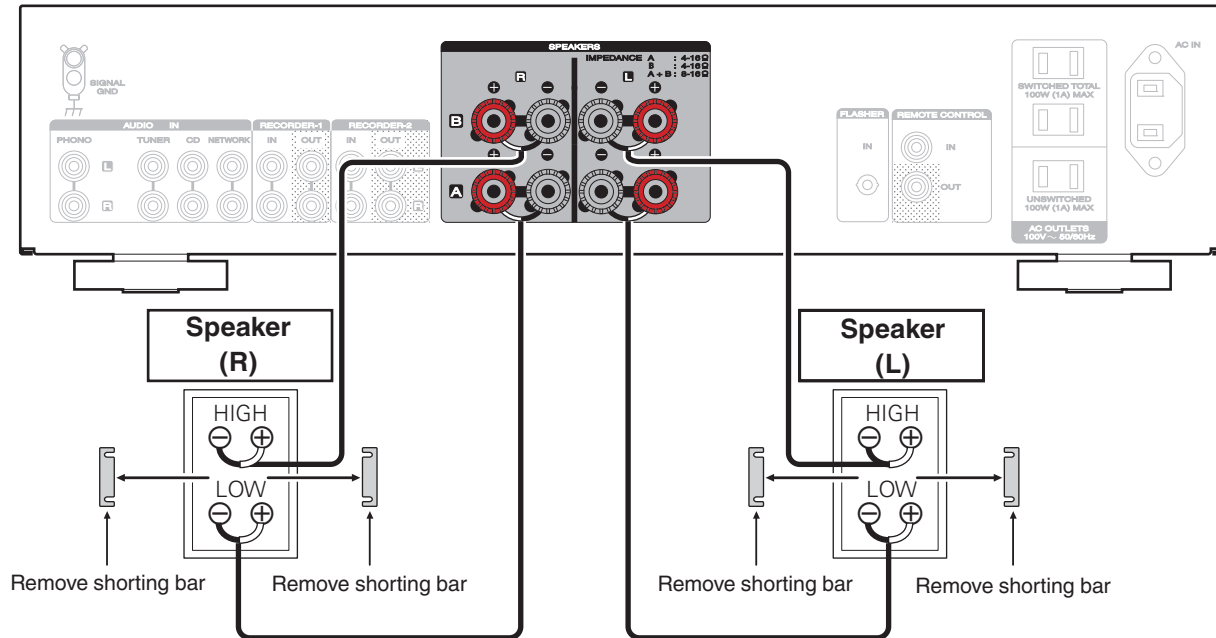

Connecting a playback device

You can connect turntables, tuners, CD players and network audio players to this unit.

This unit is compatible with turntables equipped with a moving magnet (MM) phono cartridge. When you connect to a turntable with a low output moving coil (MC) cartridge, use a commercially available MC head amp or a step-up transformer.

If you set this unit's input source to "PHONO" and you accidentally increase the volume without having a turntable connected, you may hear a hum noise from the speakers.

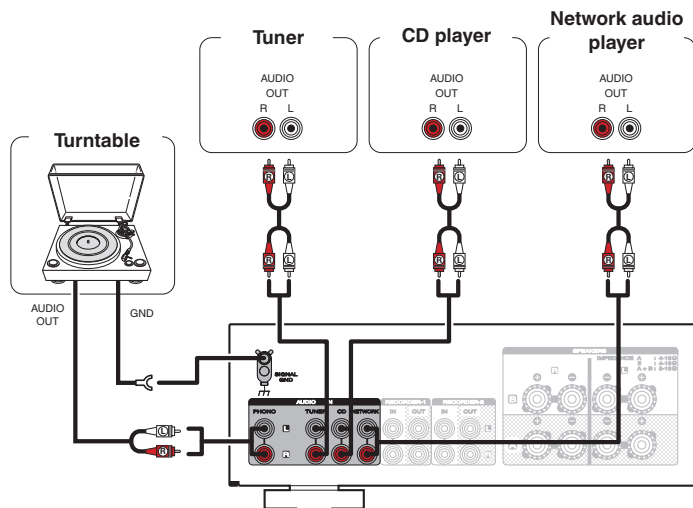

NOTE

The earth terminal (SIGNAL GND) of this unit is not for safety grounding purposes. If this terminal is connected when there is a lot of noise, the noise can be reduced. Note that depending on the turntable, connecting the ground line may have the reverse effect of increasing noise. In this case, it is not necessary to connect the ground line.



Connecting a recording device

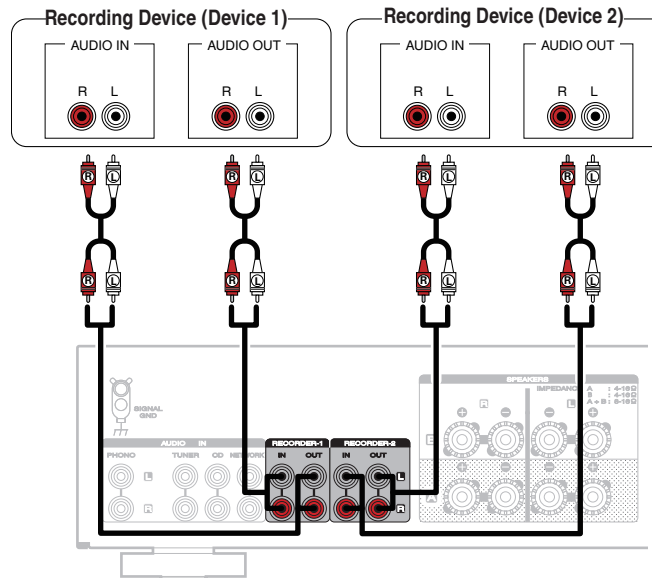

NOTE

Never insert the short-circuiting pin plug into the recording output connectors (RECORDER). Doing so could result in damage.



Connecting devices with remote control connectors

Performing operations by RC on this unit without visual contact

You can connect an external IR receiver to the REMOTE CONTROL connectors to perform operations on this unit with the supplied remote control unit without visual contact. This might be necessary if the unit is hidden in a cupboard or corner, so you can't directly point with the remote control unit to the device.

To do this, disable the remote control signal receiving function "Setting the remote signal receiving function" (🔗 p. 31).

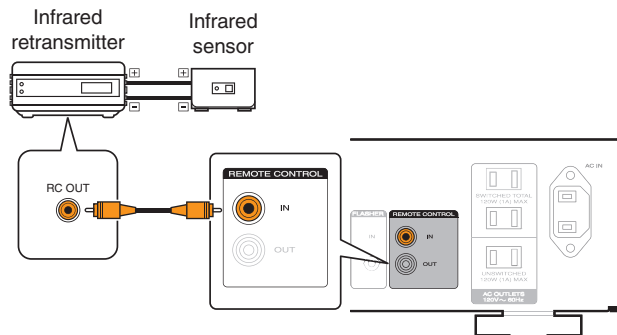

NOTE

When a remote control receiver unit is not connected, be sure to enable the remote control signal receiving function. Operations cannot be performed with the remote control if this function is disabled.

Remotely connecting Marantz audio devices

You can transmit remote control signals simply by connecting a Marantz audio device to the REMOTE CONTROL IN/OUT connectors using the remote connection cable provided with the device.

Set the remote control switch located on the rear panel of the connected audio component to "EXTERNAL" to use this feature.

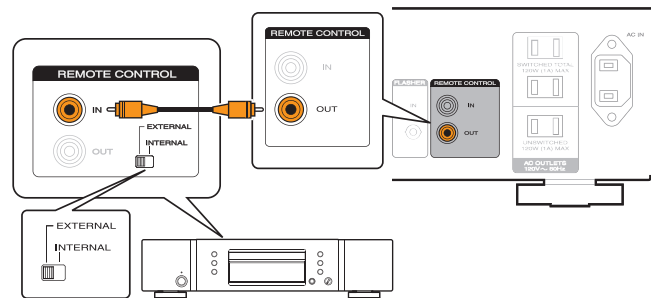

Connecting the power cord

Wait until all connections have been completed before connecting the power cord.

■ Connection to the AC outlet

You can use the AC outlets of this unit to supply power to other AV equipment.

□ SWITCHED

The “SWITCHED” AC outlet turns on/off the power supply in sync with power on/standby of this unit.

You can connect AV equipment that has total power consumption of up to 120 W (1A).

□ UNSWITCHED

The “UNSWITCHED” AC outlet supplies power regardless of power on/standby of this unit.

You can connect AV equipment that has maximum power consumption of up to 120 W (1A).

WARNING :

Do not connect AV equipment exceeding the absolute allowable power. If you do, it could result in fire or electric shock.

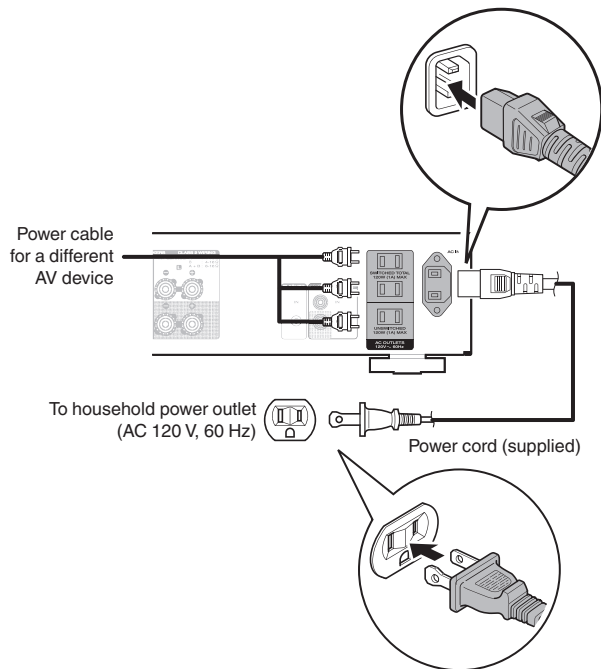

■ Contents

Turning the power on	25
Selecting the speakers for audio output	26
Selecting the input source	26
Adjusting the volume	26
Turning off the sound temporarily (Muting)	26
Adjusting the tone	26
Playing CDs	27
Recording	28



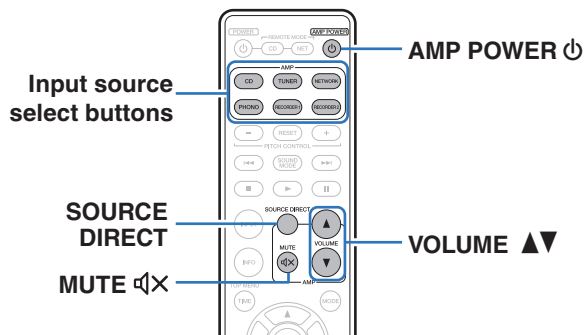

Turning the power on

- 1 Press **AMP POWER** on this unit to turn the power on.
Input indicator for the selected source lights.



- Press AMP POWER to turn on power from standby mode.
- You can turn the INPUT SELECTOR when the unit is in standby mode to turn on the power.

NOTE

Turn VOLUME on this unit to adjust the volume to the lowest level before turning on the power.

Turning the power off

- 1 Press **AMP POWER** on this unit to turn the power off.
All lit indicators turn off.

Switching the power to standby

- 1 Press **AMP POWER** on the remote control.
The standby indicator lights in red.

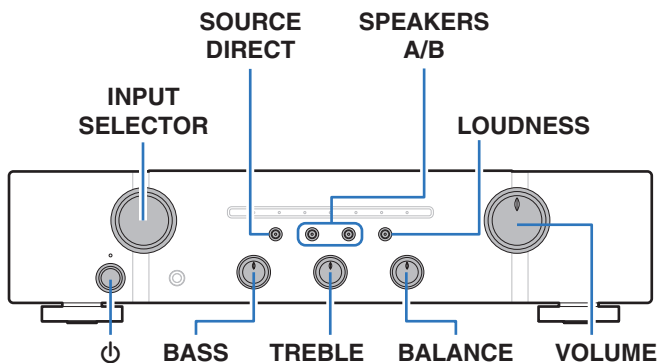

Selecting the speakers for audio output

- 1 Press **SPEAKERS A/B** to select the speaker system to be used for playback.

The indicator of the selected speakers lights.



When using headphones, press **SPEAKERS A/B** to turn off all of the indicators and turn audio output from the speaker terminals off.

Selecting the input source

- 1 Press the **input source select button** to be played back.

The indicator of the selected input source lights.



You can also select the input source by turning **INPUT SELECTOR** on the main unit.

Adjusting the volume

- 1 Press **VOLUME ▲▼** to adjust the volume.



You can also adjust the master volume by turning **VOLUME** on the main unit.

Turning off the sound temporarily (Muting)

- 1 Press **MUTE** .

The mute indicator lights.



To cancel mute, press **MUTE**  again.

Adjusting the tone

- 1 Press **SOURCE DIRECT** to turn off source direct mode.

The **SOURCE DIRECT** indicator turns off.

- 2 Turn the **BASS**, **TREBLE** and **BALANCE** to adjust the tone.





You can also press **SOURCE DIRECT** on this unit to turn off source direct mode.



Playing CDs

This section uses playback from a CD as an example.

- 1 Press  on this unit to turn the power on.**
- 2 Press the input source select button to switch the input source to “CD”.**
The “CD” input indicator lights.
- 3 Playback the CD.**
- 4 Press VOLUME   to adjust the volume.**

■ Playback in source direct mode

The signal does not pass through the tone adjustment circuitry (BASS, TREBLE and BALANCE), resulting in playback of a higher sound quality.

- 1 Press SOURCE DIRECT to turn on source direct mode.**
The SOURCE DIRECT indicator lights.

■ Playback in LOUDNESS mode

When music is played at a low volume level, the effect of the bass and treble cannot be heard easily. The LOUDNESS function corrects the bass and treble in these situations, allowing you to enjoy natural-sounding playback.

- 1 Press LOUDNESS to turn on LOUDNESS mode.**
The LOUDNESS indicator lights.



Recording

Audio signals input into this unit can be output to an external recording device. When recording audio from a playback device connected to this unit, audio can be recorded with the playback device still connected to this unit.

- 1 Press  on this unit to turn the power on.**
- 2 Press the input source select button to switch to the input source from which you want to record.**

The indicator of the selected input source lights.

- 3 Recording starts.**

- For information on operations, see the owner's manual of the recording device.



■ Contents

Setting the Auto Standby mode	30
Setting the remote signal receiving function	31
Setting remote control codes	32



Setting the Auto Standby mode

You can set the unit to automatically switch to standby mode if the unit is not operated for 30 minutes when there is no audio input (Auto Standby mode).

Auto Standby mode is set to off by default.

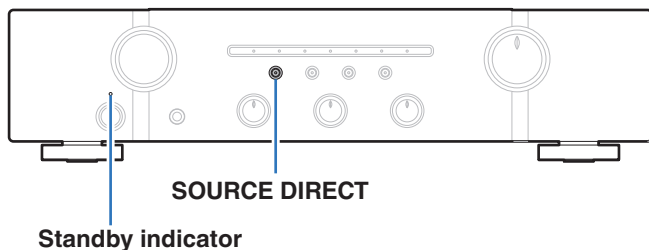

Turning Auto Standby mode on

- 1 **Press and hold SOURCE DIRECT for more than 5 seconds to turn the Auto Standby mode on.**
The standby indicator flashes three times.

Turning Auto Standby mode off

- 1 **Press and hold SOURCE DIRECT for more than 5 seconds to turn the Auto Standby mode off.**
The power indicator flashes once.



You can also press SOURCE DIRECT on the remote control unit for this operation.



Setting the remote signal receiving function

When you connect a IR receiver (sold separately) to the REMOTE CONTROL IN connector of this unit, use the following procedure to disable the remote signal receiving function of this unit. When the function is enabled, you can not perform operations with the remote control unit.

By default, this function is enabled.

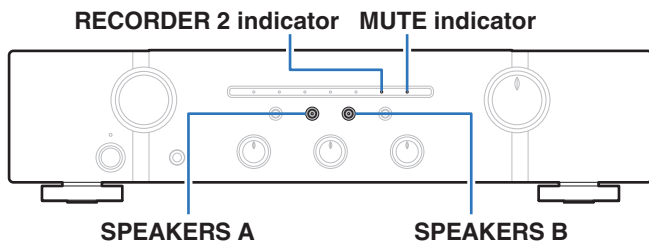

Disabling the remote signal receiving function of the remote control unit

- 1 Press **SPEAKERS B** for approximately 5 seconds to disable the remote control signal receiving function. The MUTE indicator flashes three times.

Enabling the remote signal receiving function of the remote control unit

- 1 Press **SPEAKERS A** for approximately 5 seconds to enable the remote control signal receiving function. The "RECORDER2" input indicator flashes three times.



Setting remote control codes

REMOTE
MODE CD

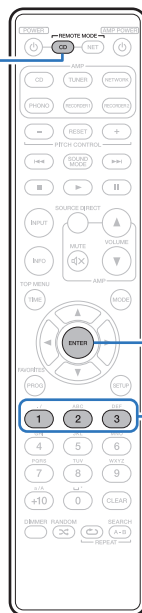

ENTER

1 - 3

Remote control codes are set between this unit and the supplied remote control. You can select one of the three types of remote control codes, and the remote control can be used to control the unit when the same remote control code is used. If three of these units are used in the same location, all three units can be controlled simultaneously using one remote control in the default settings. By setting individual remote control codes between a unit and the remote control, the remote control can be used to control only the unit that has the same remote control code.

Be sure to check the operation of each unit after setting the remote control codes.

The default setting is “AMP1”.



Setting remote control codes for the remote control

■ To set the remote control codes to AMP2

- 1 Hold down REMOTE MODE CD and the number 2 button for more than 5 seconds.

■ To set the remote control codes to AMP3

- 1 Hold down REMOTE MODE CD and the number 3 button for more than 5 seconds.



To return the remote control code to the default setting, hold down REMOTE MODE CD and the number 1 button for more than 5 seconds.

NOTE

The remote control codes returns to the default settings when the batteries are removed. Set the remote control codes again after replacing the batteries.

Setting remote control codes for this unit

- 1 Point the remote control for which the remote control code was set at this unit, and press REMOTE MODE CD and ENTER.

The input indicators on the unit flash as shown below according to the set remote control code.

Remote control codes	Input indicator
AMP 1	PHONO indicator flashes three times
AMP 2	TUNER indicator flashes three times
AMP 3	CD indicator flashes three times



■ Contents

Tips

I want to adjust the tone myself	35
I want sound playback that is faithful to the original sound	35
I want to hear music that is close to the original sound quality at low volume	35
I want to operate a Marantz CD player or network audio player using the remote control of this unit	35
I want to use more than one unit in one location	35

Troubleshooting

Power does not turn on / Power is turned off	36
Operations cannot be performed through the remote control unit	37
No sound comes out	38
Desired sound does not come out	38
Sound is interrupted or noise occurs	39



Tips

I want to adjust the tone myself

- Use the BASS, TREBLE and BALANCE knobs to adjust the sound as desired. (👉 p. 26)

I want sound playback that is faithful to the original sound

- Set the Source Direct mode on. (👉 p. 27)

I want to hear music that is close to the original sound quality at low volume

- Turn the LOUDNESS mode on. (👉 p. 27)

I want to operate a Marantz CD player or network audio player using the remote control of this unit

- Switch the remote control operating mode. (👉 p. 12, 14)
- Also refer to the CD player or network audio player instruction manuals.

I want to use more than one unit in one location

- Set individual remote control codes for each combination of devices and remote control. (👉 p. 33)



Troubleshooting

1. Are the connections correct?
2. Is the set being operated as described in the owner's manual?
3. Are the other devices operating properly?

If this unit does not operate properly, check the corresponding symptoms in this section.

If none of the symptoms are applicable, consult your dealer as it could be due to a fault in this unit. In this case, disconnect the power immediately and contact the store where you purchased this unit.

■ Power does not turn on / Power is turned off

Symptom	Cause / Solution	Page
Power is not turned on.	<ul style="list-style-type: none"> • Check whether the power plug is correctly inserted into the power outlet. 	<u>23</u>
Power automatically turns off.	<ul style="list-style-type: none"> • The Auto Standby mode is on. When approx. 30 minutes pass with no audio input and no operations on the unit, this unit automatically enters the standby mode. To turn off the Auto Standby mode, press the SOURCE DIRECT button for 5 seconds or longer. 	<u>30</u>
Power turns off and the power indicator flashes in red approx. every 0.25 seconds.	<ul style="list-style-type: none"> • The protection circuit has been activated due to a rise in temperature within this unit. Turn the power off, wait about an hour until this unit cools down sufficiently, and then turn the power on again. 	<u>40</u>
	<ul style="list-style-type: none"> • Please re-install this unit in a place having good ventilation. 	—
	<ul style="list-style-type: none"> • Check the speaker connections. The protection circuit may have been activated because speaker cable core wires came in contact with each other or a core wire was disconnected from the connector and came in contact with the rear panel of this unit. After unplugging the power cord, take corrective action such as firmly re-twisting the core wire or taking care of the connector, and then reconnect the wire. 	<u>17</u>
	<ul style="list-style-type: none"> • Turn down the volume and turn on the power again. 	<u>25</u>
	<ul style="list-style-type: none"> • This unit's amplifier circuit has failed. Unplug the power cord and contact our customer service center. 	—



■ Operations cannot be performed through the remote control unit

Symptom	Cause / Solution	Page
Operations cannot be performed through the remote control unit.	• Batteries are worn out. Replace with new batteries.	5
	• Operate the remote control unit within a distance of about 23 ft/7 m from this unit and at an angle of within 30°.	5
	• Remove any obstacle between this unit and the remote control unit.	—
	• Insert the batteries in the proper direction, checking the ⊕ and ⊖ marks.	5
	• The set's remote control sensor is exposed to strong light (direct sunlight, inverter type fluorescent bulb light, etc.). Move the set to a place in which the remote control sensor will not be exposed to strong light.	—
	• When using a 3D video device, the remote control unit of this unit may not function due to effects of infrared communications between units (such as TV and glasses for 3D viewing). In this case, adjust the direction of units with the 3D communications function and their distance to ensure they do not affect operations from the remote control unit of this unit.	—
	• Enable the remote signal receiving function.	31
	• The remote control code between this unit and the remote control is different. Set this unit and the remote control to the same remote control code.	33



■ No sound comes out

Symptom	Cause / Solution	Page
No sound comes out of speakers.	• Check the connections for all devices.	<u>16</u>
	• Insert connection cables all the way in.	—
	• Check that input connectors and output connectors are not reversely connected.	—
	• Check cables for damage.	—
	• Check that speaker cables are properly connected. Check that cable core wires come in contact with the metal part on speaker terminals.	<u>17</u>
	• Securely tighten the speaker terminals. Check speaker terminals for looseness.	<u>17</u>
	• Check that the proper input source is selected.	<u>26</u>
	• Adjust the master volume.	<u>26</u>
	• Cancel the muting mode.	<u>26</u>
• Check the settings of the SPEAKERS A/B button.	<u>26</u>	

■ Desired sound does not come out

Symptom	Cause / Solution	Page
No sound comes out of a specific speaker.	• Check that speaker cables are properly connected.	<u>17</u>
	• Adjust the BALANCE control knob.	<u>26</u>
The left and right of stereo sound is reversed.	• Check whether the left and right speakers are connected to the correct speaker terminals.	<u>17</u>



■ Sound is interrupted or noise occurs

Symptom	Cause / Solution	Page
When playing a record, the sound is distorted.	• Adjust to a proper needle pressure.	—
	• Check the tip of the needle.	—
	• Replace the cartridge.	—
When playing a record, a humming noise comes out of the speakers.	• Check that the turntable is connected correctly.	<u>20</u>
	• If there is a TV or AV device near the turntable, such devices may affect the playback sound. Install the turntable in a location as far away as possible from the TV or other AV devices.	—
When playing a record, a humming noise comes out of the speakers when the volume is high. (Howling phenomenon)	• Install the turntable and speakers as far from each other as possible.	<u>20</u>
	• The vibrations from the speakers are being transmitted to the player through the floor. Use cushions, etc., to absorb the speakers' vibrations.	—



Explanation of terms

Speaker impedance

This is an AC resistance value, indicated in Ω (Ohms).

Greater power can be obtained when this value is smaller.

Source direct

Playback with higher fidelity to the source becomes possible, as input audio signals are output by bypassing the audio quality-control circuits (BASS/TREBLE/BALANCE).

Protection circuit

This is a function to prevent damage to devices within the power supply when an abnormality such as an overload, excess voltage occurs or over temperature for any reason.

If a malfunction occurs in this unit, the power indicator blinks red and the unit switches to standby mode.



Specifications

• RMS Power output (40 Hz – 20 kHz simultaneous drive of both channels) :	40 W x 2 (8 Ω/ohms load) 55 W x 2 (4 Ω/ohms load)
• Total harmonic distortion (40 Hz – 20 kHz simultaneous drive of both channels, 8 Ω/ohms load) :	0.01 %
• Output band width (8 Ω/ohms load, 0.06 %) :	10 Hz – 30 kHz
• Frequency response (CD, 1 W, 8 Ω/ohms load) :	10 Hz – 50 kHz +0 dB, -1 dB
• Dumping factor (8 Ω/ohms load, 40 Hz – 20 kHz) :	100
• Input sensitivity/Input impedance	
PHONO (MM) :	2.2 mV/47 kΩ/kohms
CD, TUNER, NETWORK, RECORDER :	200 mV/20 kΩ/kohms
• Maximum allowable PHONO input level (1 kHz) MM :	110 mV
• RIAA deviation (40 Hz – 20 kHz) :	±0.5 dB
• S/N (IHF-A, 8 Ω/ohms load)	
PHONO (MM) :	83 dB (5 mV input, 1 W output)
CD, TUNER, NETWORK, RECORDER :	103 dB (2 V input, Rated output)
• Tone Control	
BASS (100 Hz) :	±10 dB
TREBLE (10 kHz) :	±10 dB
• Power requirement :	AC 120 V, 60 Hz
• Power consumption (EN60065) :	350 W
• Power consumption in standby mode :	0.3 W

For the purpose of improvement, the specifications and design are subject to change without notice.



■ **Dimensions** (Unit : in. (mm))

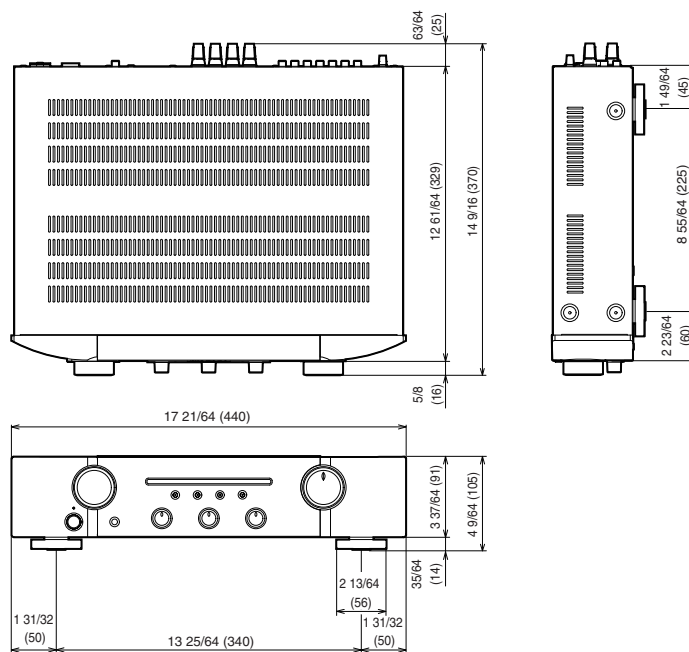

■ **Weight : 14 lb 12 oz (6.7 kg)**



Index

A	
Adjusting the tone	26
Adjusting the volume	26
Auto Standby mode	30
B	
BALANCE	26
BASS	26
C	
Cables	16
Connecting a playback device	20
Connecting a recording device	21
Connecting speakers	17
Connecting a power cord	23
I	
Inserting the batteries	5
L	
LOUDNESS mode	27
P	
Protection circuit	40
R	
Remote control	22
Remote control codes settings	33
Remote control unit	11
S	
Selecting the input source	26
Source direct	27, 40
Speaker impedance	40
Speaker (Bi-wiring) connection	19
T	
Tips	35
TREBLE	26
Troubleshooting	36
Turning off the sound temporarily (Muting)	26



www.marantz.com

You can find your nearest authorized distributor or dealer on our website.

marantz[®] is a registered trademark.

D&M Holdings Inc.
3520 10333 00AM