



Basic Manual

VSX-831

AV Receiver

Hookup	
Step1: Connect the Speakers	3
Step2: Connect the TV	5
Step3: Connect the AV Components	7
Step4: Connect Other Cables	10
Setup	
Step5: Power On & Initial Setup	11
HDMI Setup	12
Playback	
Basic Playback	13
Network Functions	14
Others	16
Part Names	
Front Panel	18
Rear Panel	19
Remote Controller	20
Display	20

[The Basic Manual](#) includes information needed when starting up and also instructions for frequently used operations. [The Advanced Manual](#) has more detailed information and advanced settings.



What's in the box

1. Main unit
2. Remote controller (RC-914R) ×1, Batteries (AAA/R03) ×2
3. Indoor FM antenna ×1
4. AM loop antenna ×1
5. Speaker setup microphone ×1

Main features

This unit is connected between your TV and your AV components. To play, select the source with the input selector. You can connect 5.1ch of speakers to this unit, with 5ch at 140 W (6 ohms, 1 kHz, 0.9%THD) (North American models) / 130 W (6 ohms, 1 kHz, 1%THD) (European, Australian and Asian models) per channel plus a powered subwoofer pre out jack.

- The HDMI jack supports 4K video input and output. Jacks IN1 to 3 and OUT support HDCP2.2
- HDMI CEC functionality: Control features such as linking input switching with the input selector and players conforming to the CEC standard, switching audio output and volume using the remote controller of a CEC-compliant TV, and automatically switching this unit to standby when the TV is turned off
- HDMI Standby Through: Video and audio signals from AV components can be transmitted to the TV even if this unit is in standby
- ARC: Connection with an ARC-compatible TV is complete with one HDMI cable
- Easy Initial Setup using onscreen guidance and On-Screen Display (OSD) showing operations on the TV
- Internet radio and AirPlay via wired LAN or Wi-Fi (wireless LAN) and network features such as Music Server that enables PC music file playback, USB playback, plus other playback features such as AM/FM radio and BLUETOOTH® play
- Playback formats supported by Music Server and USB include WAV, FLAC and DSD high-res source

-
- i CAUTION:** Connect speakers with 6 Ω to 16 Ω impedance. The power cord must be connected only after all other cable connections are completed.
- We will not accept responsibility for damage arising from the connection of equipment manufactured by other companies.
-

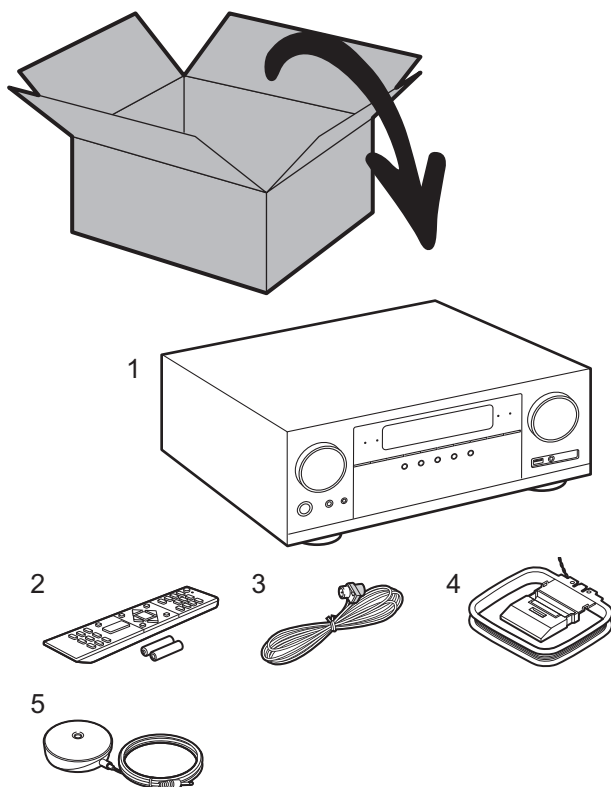



Step1: Connect the Speakers

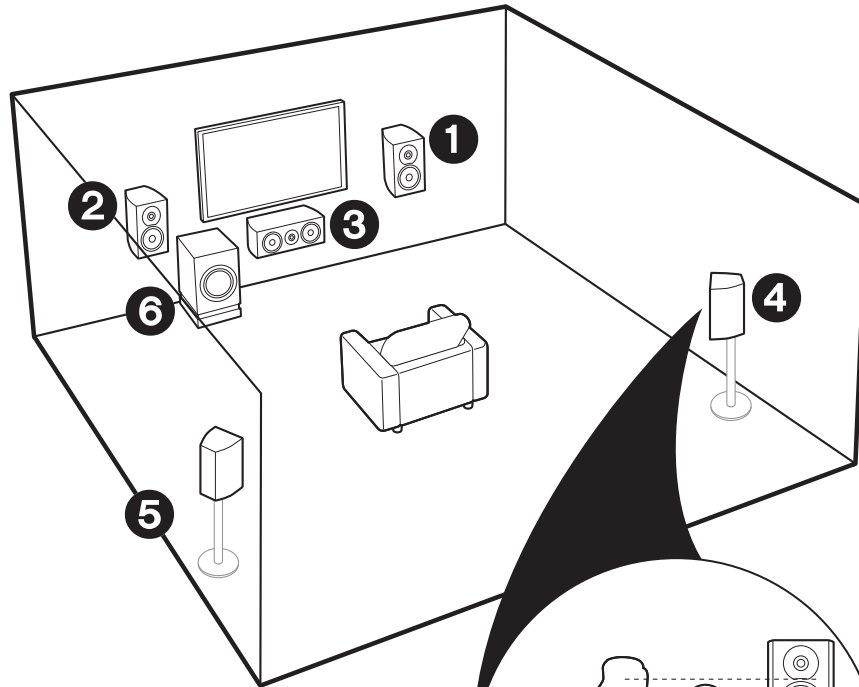

- 1 2** Front Speakers
- 3** Center Speaker
- 4 5** Surround Speakers
- 6** Powered Subwoofer

✓ Speaker Layout for 5.1-Channel System

Front speakers output front stereo sound and a center speaker outputs center sound such as dialogs and vocals. Surround speakers create back sound field. Powered subwoofer reproduces bass sounds and creates rich sound field. The front speakers should be positioned at ear height, while the surround speakers should be positioned just above ear height. Center speaker should be set up facing the listening position. Place the powered subwoofer towards the front. Placing it between the center speaker and a front speaker gives you a natural sound even when playing music.

- The front speakers, center speaker, and surround speakers are counted as 5 channels, and the powered subwoofer is counted as 0.1 of a channel, giving us the name 5.1ch system.

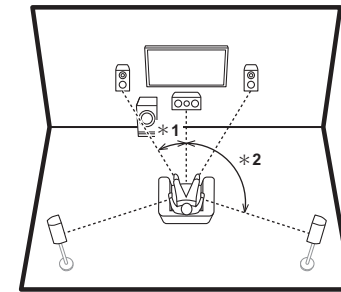

* 1: 22° to 30°, * 2: 120°

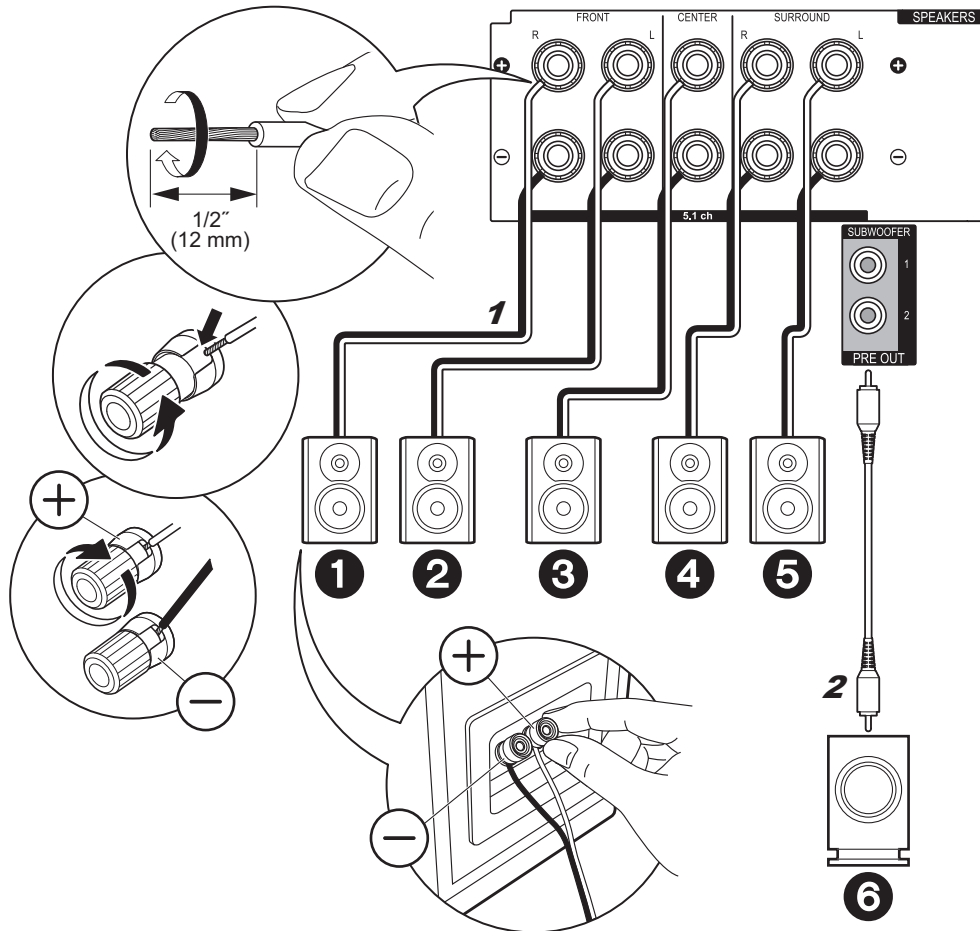

✓ Connections for 5.1-Channel System

Connect **123456** for a 5.1-channel system. Up to two powered subwoofers can be connected. The same signal is output from each of the SUBWOOFER jacks. Note that it is possible to connect just **12** and no other jacks.



Setup

- The speaker configuration is set to 5.1ch audio output by default. If there are speakers you won't be connecting, you need to change the settings in Initial Setup, "1. Full Auto MCACC" (→P11) so that the audio from those speakers you are not connecting is sent to other speakers.

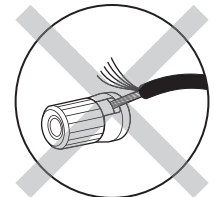

Make sure the exposed wires of the speakers do not stick out of the speaker terminals when connecting. If the exposed wires of the speakers touch the rear panel or the + and - wires touch each other, the protection circuit will be activated.

1 Speaker cable, 2 Subwoofer cable



Step2: Connect the TV

✓ if you have:
ARC TV

This unit is connected between your TV and AV components. If you connect two or more AV components, you can select the video displayed on the TV and the audio output from this unit by changing the input selector. Shown here are the connections for a TV that supports the ARC (Audio Return Channel) feature. By connecting with a single HDMI cable, you can not only output the video input to this unit to the TV, but you can also play the sound from the TV through this unit. Choose an HDMI IN jack on the TV that supports ARC when connecting.



Setup

- Settings are required to use the ARC function. Select "Yes" in "4. Audio Return Channel" (→P12) in the Initial Setup.
- Please refer to the TV's operation manual for directions on connections and setup for the TV.

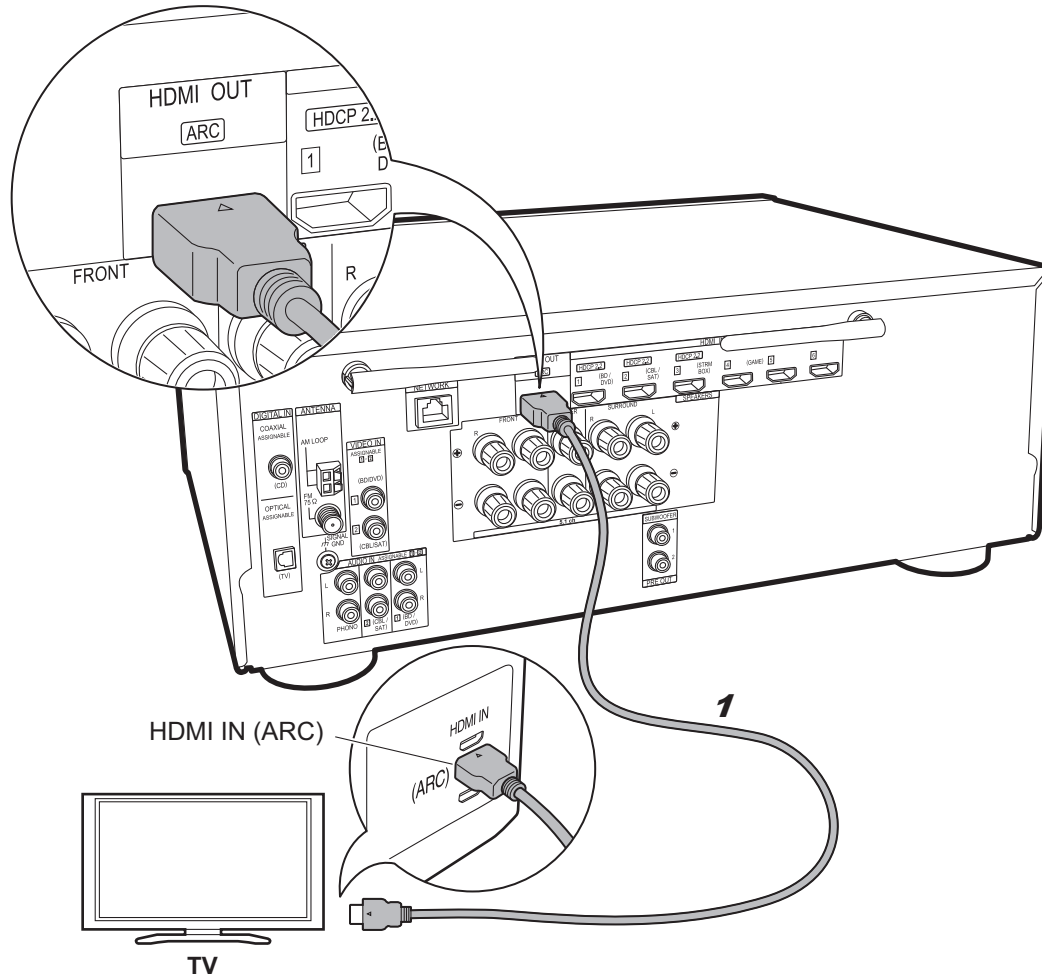

1 HDMI cable



Step3: Connect the AV Components

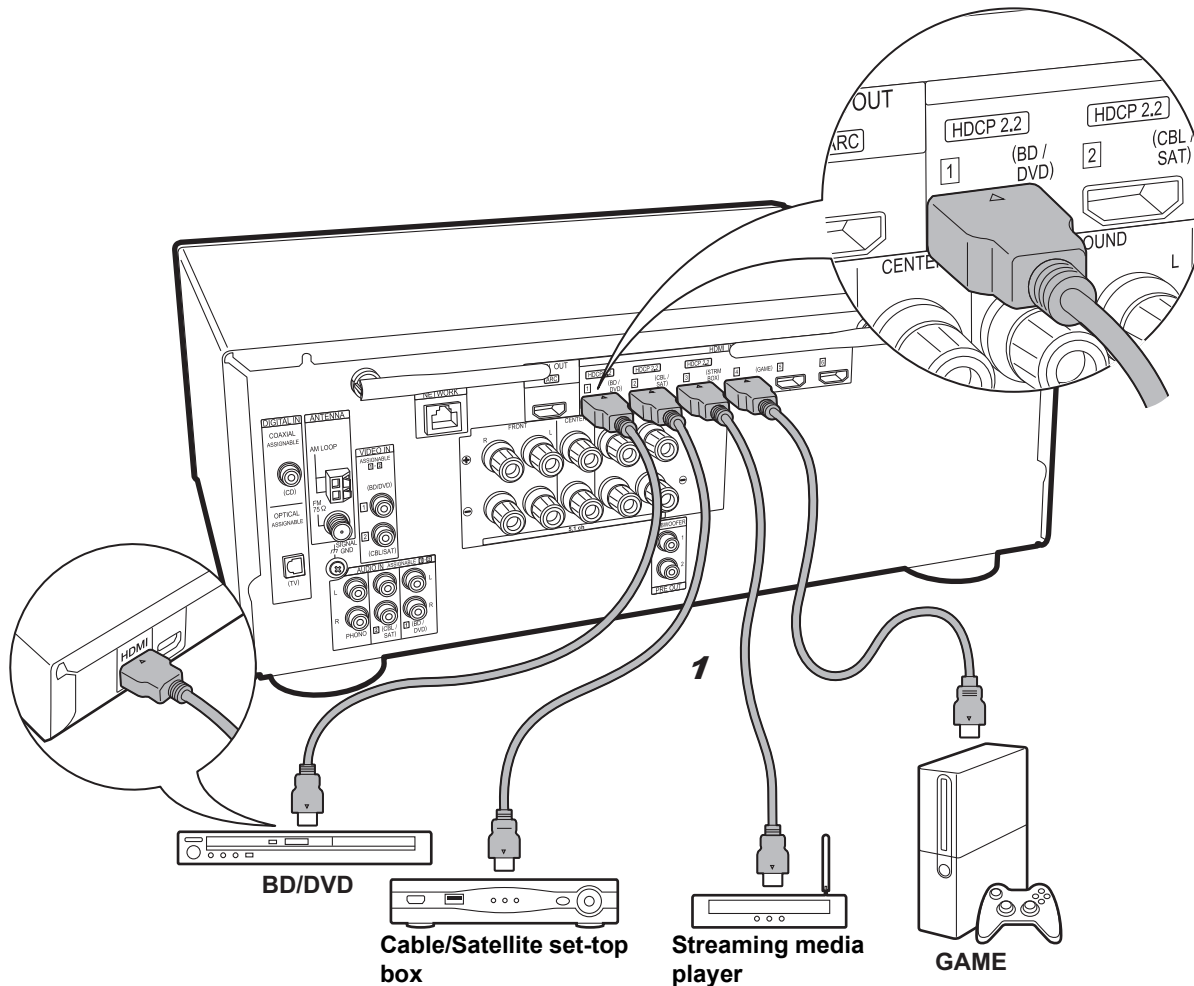

1 HDMI cable

✓ if you have: HDMI AV Components

This is an example of connection with an AV component that has an HDMI jack. With connection to an AV component that conforms with the CEC (Consumer Electronics Control) standard, you can use features such as the HDMI CEC feature that links with the input selector, and the HDMI Standby Through feature which allows you to play video and audio from AV components on the TV even when this unit is in standby mode.

- To play 4K or 1080p video, use a high speed HDMI cable. Further, to enjoy HDCP2.2 compatible video, connect to the HDMI IN1 to IN3 jacks.



Setup

- HDMI setup (→P12) is required to use the HDMI CEC and HDMI Standby Through features. Make settings after all connections are complete.
- To enjoy digital surround sound including Dolby Digital, audio output should be set to "Bitstream output" on the connected Blu-ray Disc player or other device.

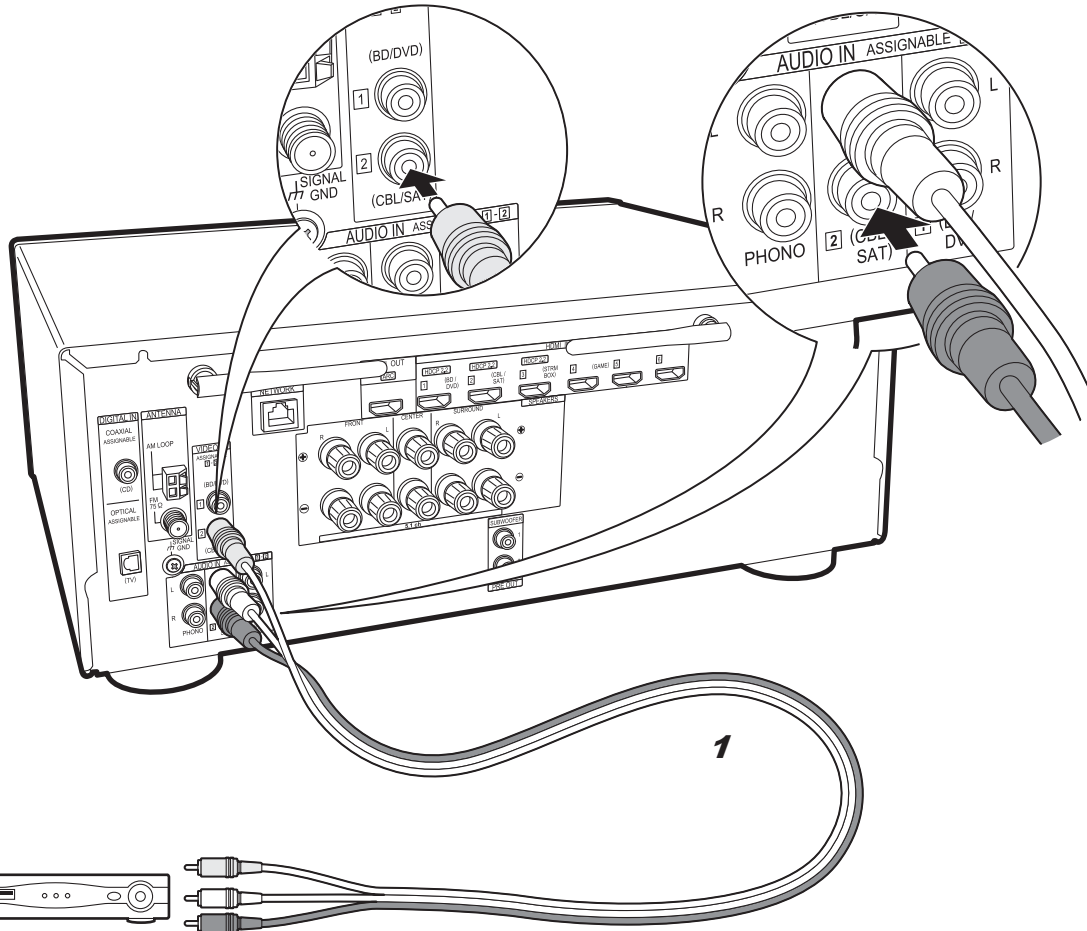

Cable/Satellite set-top box

1 Analog audio/video cable

✓ if you have:
Non-HDMI AV Components

This is an example of connection with an AV component that does not have an HDMI jack. Make the connections to the AV component to match the jacks it has. When video input connection is to the CBL/SAT jack, the audio input connection should also be to the CBL/SAT jacks, and so on, so that you connect the video input jacks to the jacks with the same name as the audio input jacks. Note that video signals input to the VIDEO IN jack will be upconverted to HDMI signals and then output from the HDMI OUT jack.

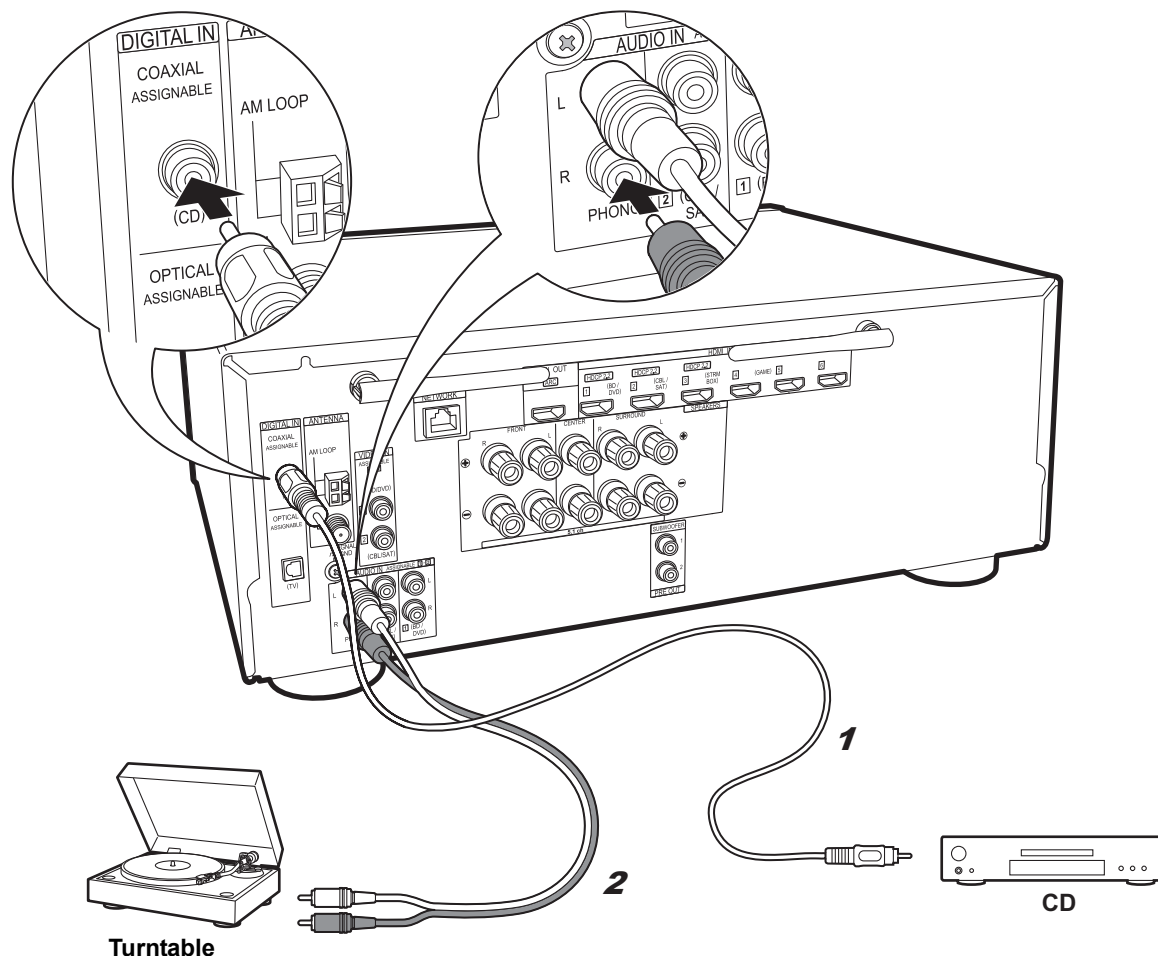

✓ if you have:
Audio Components

Example of a connection with an audio component. You can connect a turntable that has an MM-type cartridge to the PHONO jack.

- If the turntable has a built-in audio equalizer, connect it to another AUDIO IN jack. Further, if the turntable uses an MC type cartridge, install an audio equalizer compatible with the MC type cartridge between the unit and the turntable, then connect to any AUDIO IN jack other than the PHONO jack.

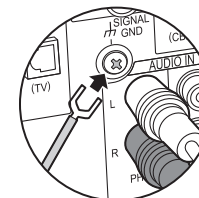

If the turntable has a ground wire, connect it to the SIGNAL GND terminal of this unit.

1 Digital coaxial cable, 2 Analog audio cable

Step4: Connect Other Cables

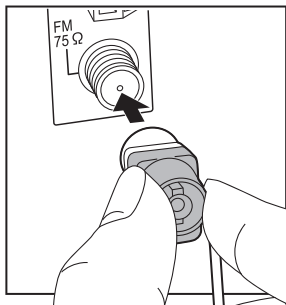
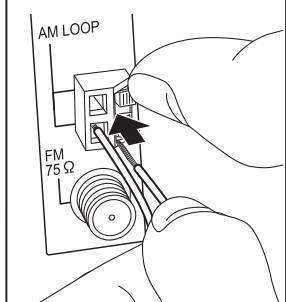
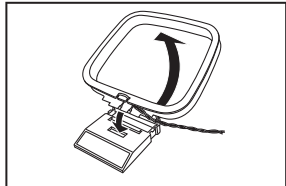
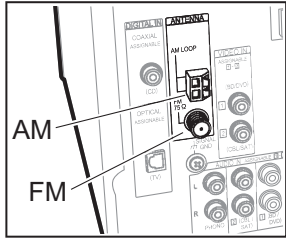

Antenna Hookup

Move the antenna around while playing the radio to find the position with the best reception. Use a thumb tack or similar to attach the indoor FM antenna to a wall.



AM loop antenna

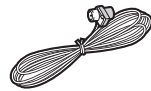

Indoor FM antenna

(North American models)



(European, Australian and Asian models)

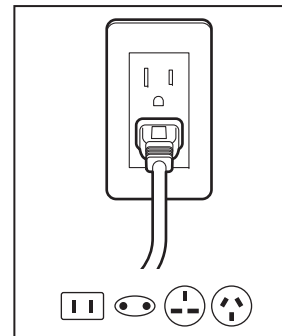
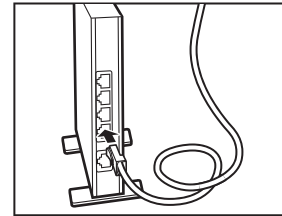
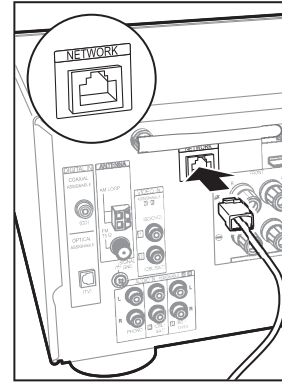
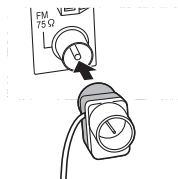

Network Hookup

Connect this unit to the network using wired LAN or Wi-Fi (wireless LAN). You can enjoy network features such as internet radio, Music Server, and AirPlay by connecting the unit to the network.

If you connect by wired LAN, connect with an Ethernet cable to the NETWORK port as shown in the illustration. To connect by Wi-Fi, then after selecting "Wireless" in "3. Network Connection" (→P12) in Initial Setup, select the desired setting method and follow the onscreen instructions to configure the connection.

Power Cord Hookup

Connect the power cord to the power outlet after completing all other connections.



Step5: Power On & Initial Setup

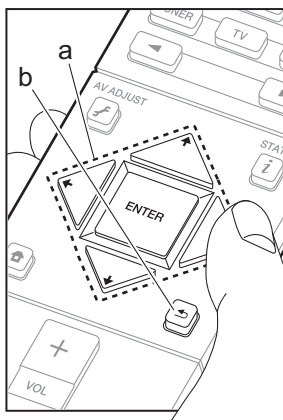
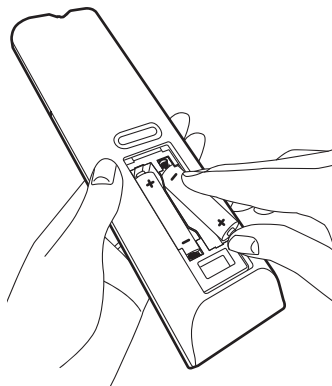
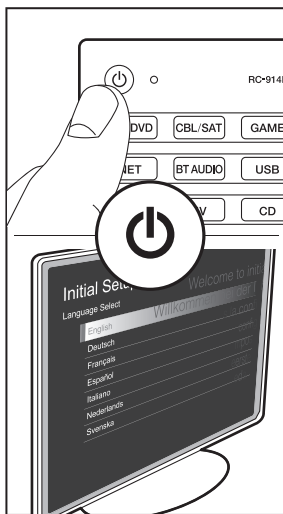
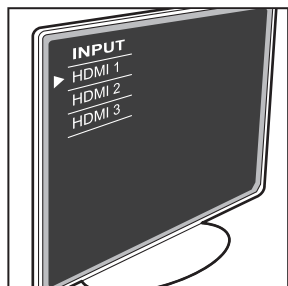

Initial Setup starts automatically

Once all connections are complete, change the TV's input to the input for this unit, inset batteries in the remote controller, and press **⏻** to turn the power on. When you turn the unit on for the first time, Initial Setup is automatically shown on the TV to enable you to make settings required for startup using simple operations following onscreen guidance.

These instructions will guide you through some items that you need to check beforehand. Read beforehand so the setup goes smoothly.

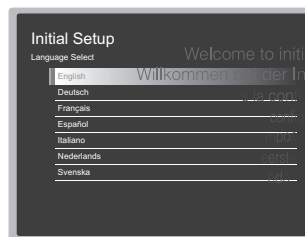

Operation

Select the item with the cursors of the remote controller and press ENTER (a). To return to the previous screen, press **←** (b).

To redo the Initial Setup

If you terminate the procedure on the way or want to change a setting made during Initial Setup, press **⏻** on the remote controller, select "System Setup" – "Miscellaneous" – "Initial Setup" from Home, and press ENTER.

1. Full Auto MCACC

Place the supplied speaker setup microphone in the listening position, measure the test tones emitted by the speakers, then the unit automatically sets the optimum volume level for each speaker, the crossover frequencies, and the distance from the listening position. This also enables correction of distortion caused by the acoustic environment of the room.

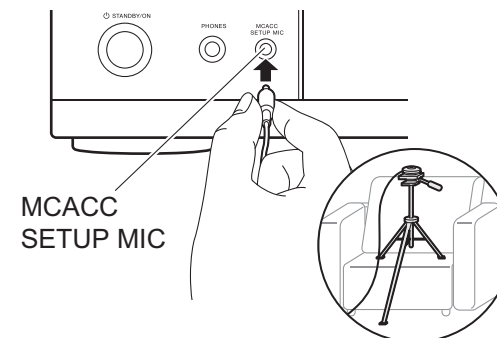

MCACC
SETUP MIC

- Use a tripod or similar to place the speaker setup microphone at ear height.
- The subwoofer sound may not be detected since it is extremely low frequencies. Set the subwoofer volume to more than halfway.
- Calibration takes several minutes to be completed. The speakers emit the test tone at high volume during measurement, so be careful of your surroundings. Keep the room as quiet as possible during measurement. If the measurement is interrupted, turn off the household appliances.



2. Source Connection

Check that each input source is connected correctly. Follow the guidance, select the input you want to confirm, start play of the selected player, and confirm that the images appear on the TV and that sound is played.

3. Network Connection

Set up Wi-Fi connection with an access point such as a wireless LAN router. There are the following two methods of connecting by Wi-Fi:

"Scan Networks": Search for an access point from this unit. Find out the SSID of the access point beforehand.

"Use iOS Device (iOS7 or later)": Share the iOS device's Wi-Fi settings with this unit.

If you select "Scan Networks", there are a further two choices of connection method. Check the following.

- **"Enter Password"**: Enter the password (or key) of the access point to connect.
- **"Push Button"**: If the access point has an automatic connection button, you can connect without entering a password.
- If the SSID of the access point is not displayed, then in the screen listing the SSIDs, select "Other..." with the ➔ cursor on the remote controller and press ENTER, then follow the onscreen instructions.

Keyboard input



To switch between upper and lower case, select "A/a" on the screen and press ENTER. To select whether to mask the password with "*" or display it in plain text, press +Fav on the remote controller. Press CLEAR to delete all the input characters.

- A confirmation screen asking you to agree to the privacy policy is displayed during network setting. Select "Yes" and press ENTER to indicate agreement.

4. Audio Return Channel

If you have connected a TV that supports ARC, select "Yes". This unit's ARC setting turns on and you can listen to the TV's audio through this unit.

HDMI Setup

HDMI CEC

Make this setting to enable the control feature for devices complying with the CEC standard. This is set to on automatically if you have selected "Yes" in "4. Audio Return Channel" in the Initial Setup.

Press the button on the remote controller to set "System Setup" – "Hardware" – "HDMI" – "HDMI CEC" to "On" on the TV screen. Also enable the CEC control feature on the CEC device you have connected.

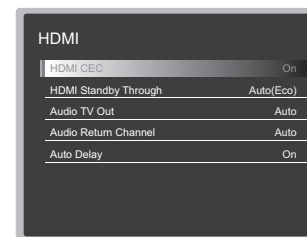

HDMI Standby Through

Even if this unit is in standby, the input signals from AV components are transmitted to the TV.

- **"Auto" / "Auto (Eco)"**: Select one of these settings when connected AV components comply with the CEC standard. Irrespective of the input selector selected immediately before switching the unit to standby, you can transmit the input signals from AV components to the TV. Select "Auto (Eco)" if the TV is also CEC-compliant. You can reduce power consumption in standby mode.
- **"Input selector names for BD/DVD, etc."**: You can transmit the input signals from the set input selector to the TV. It can be selected when "HDMI CEC" is set to "Off".
- **"Last"**: You can transfer the input signals of the input selector selected immediately prior to the unit being switched to standby. It can be selected when "HDMI CEC" is set to "Off".

To exit the settings, press .

Basic Playback

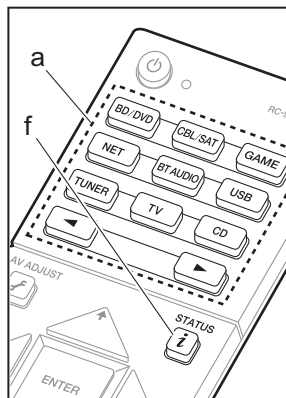

AV Component Playback

1. Switch the input on the TV to that assigned to the unit.
2. Press the input selector (a) on the remote controller with the same name as the jack to which you connected the player to switch the input.

For example, press BD/DVD to play the player connected to the BD/DVD jack. Press TV to listen the TV's sound.

You can also select input with the ◀▶ buttons.

- When the CEC link function works, the input switches automatically when you have connected a CEC compliant TV and player to this unit using HDMI connection.

3. Start play on the player.
4. Use VOL+/- (b) to adjust the volume.

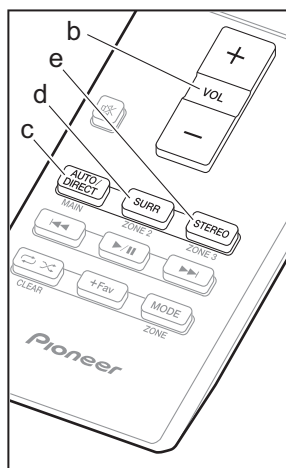

Listening Mode

This unit is equipped with a variety of listening modes. For details on the listening modes, see the Advanced Manual. This section introduces some of the popular modes.

AUTO/DIRECT button (c)

You can select the Auto Surround, Direct, and Pure Direct modes. In either case, for 2 channel input signals the Stereo mode is automatically selected that plays only from the front speakers and subwoofer, and for multi-channel input signals listening modes are automatically selected that match the input signal, so Dolby Digital for Dolby Digital sources, and DTS-HD Master Audio for DTS-HD Master Audio. The Direct mode shuts down some processing that can affect sound quality, such as the tone

control features, so you can enjoy even better sound quality. The Pure Direct mode shuts down even more processes that affects sound quality, so you get a more faithful reproduction of the original sound. In this case, the speaker calibration made with MCACC is disabled.

- Depending on the input signal and speaker configuration, the Dolby PL II Movie/Music/Game and DTS Neo:6 Cinema/Music modes that expand 2 channel input signal to 5.1 channel may be automatically selected.

SURR button (d)

You can select a variety of listening modes to suit your taste. There are the Dolby Digital, DTS-HD Master Audio, and Stereo modes that you can choose to suit the input signal, or the Dolby PL II Movie/Music/Game and DTS Neo:6 Cinema/Music modes that can expand 2 channel input signal to 5.1 channel. You can also enjoy original surround modes such as Ext.Stereo and Drama modes.

STEREO button (e)

You can select the "Stereo" mode to playback only from the front speakers and subwoofer.

The listening mode last selected for the source is remembered for each of the AUTO/DIRECT, SURR, and STEREO buttons. If content you play is not supported by the listening mode you selected last, the listening mode that is standard for that content is selected automatically. Press **i** (f) repeatedly to switch the display of the main unit in order of:

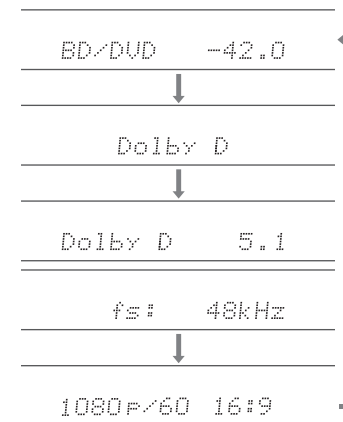

Network Functions

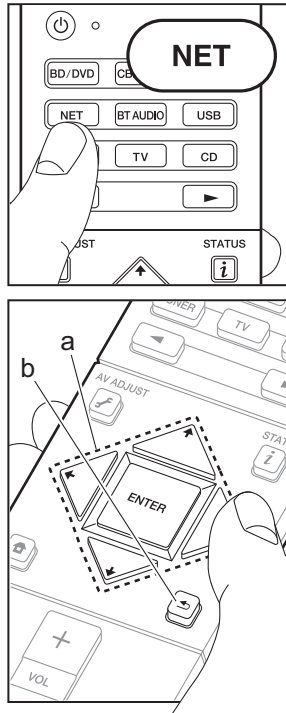

Network Services

1. Switch the input on the TV to that assigned to the unit.
2. Press NET to display the network service list screen.

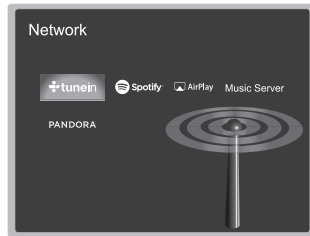

3. Select the item with the cursors of the remote controller and press ENTER to confirm your selection (a). To return to the previous screen, press ⏪ (b).

Internet Radio

When this unit is connected to a network, you can listen to TuneIn or other preregistered Internet radio services. After selecting the desired service, follow the on-screen instructions, using the cursors to select radio stations and programs, then press ENTER to play. Play starts when 100% is displayed for buffering.

Music Server

You can play music files stored on home-network compliant PCs or NAS devices connected to the same network as this unit. Select the server with the cursors, select the desired music file and press ENTER to start playback. Play starts when 100% is displayed for buffering.



Notes:

- Network services become selectable after the network starts up even if they cannot be selected first.
- Functionality may be introduced by firmware updates and service providers may cease services, meaning that some network services and content may become unavailable in the future. Furthermore, available services may vary depending on your area of residence.

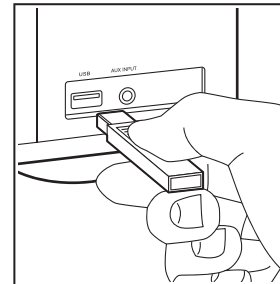

USB

Play music files on a USB storage device.

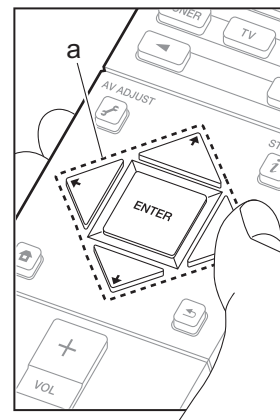
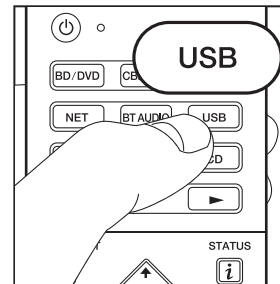

- Operation cannot be guaranteed for all USB storage devices.
1. Switch the input on the TV to that assigned to the unit.
 2. Plug your USB storage device with the music files into the USB port on the front of the unit.
 3. Press USB on the remote controller.
 4. Select the desired folder or music file with the cursors of the remote controller and press ENTER to confirm and start playback (a).
- This unit can use USB storage devices that comply with the USB mass storage device class standard. The unit is also compatible with USB storage devices using the FAT16 or FAT32 file system formats.

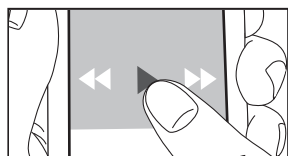
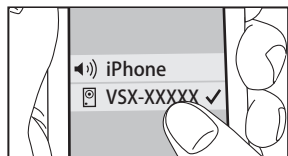
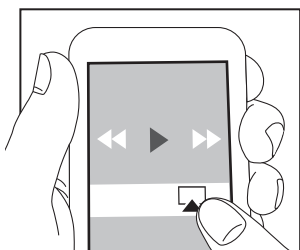
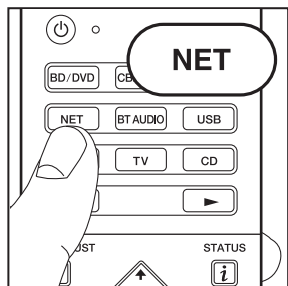



AirPlay

You can wirelessly enjoy the music files on an iPhone®, iPod touch®, or iPad® connected to the same access point as this unit.

- Update the OS version on your iOS device to the latest version.
1. Connect the iOS device to the access point.
 2. Press NET.
 3. Tap the AirPlay icon  in the control center of the iOS device and select this unit from the list of devices displayed, and tap "Done".
 4. Play the music files on the iOS device.
 - The default status is for the Network Standby feature to be on, so when you do steps 3 and 4 above, this unit automatically comes on and input switches to "NET". To reduce the amount of power consumed in standby mode, press the  button on the remote controller, then in the Home displayed set "System Setup" – "Hardware" – "Power Management" – "Network Standby" to "Off".
 - Due to the characteristics of AirPlay wireless technology, the sound produced on this unit may slightly be behind the sound played on the AirPlay-enabled device.

You can also play back music files on the computer with iTunes (Ver. 10.2 or later). Before operation, make sure this unit and the PC are connected to the same network, then press NET on this unit. Next, click the AirPlay icon  in iTunes, select this unit from the list of devices displayed, and start play of a music file.

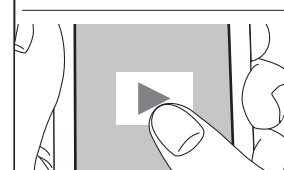
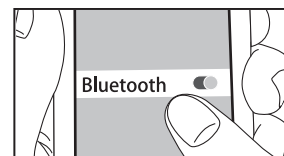
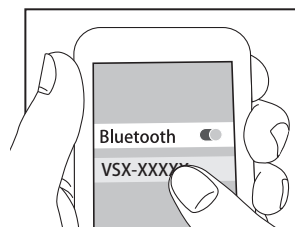
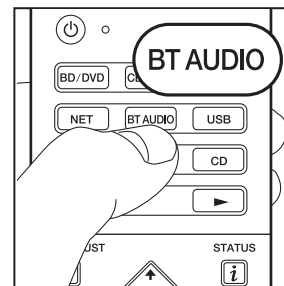

BLUETOOTH® Playback

Pairing

1. When you press BT AUDIO on the remote controller, "Now Pairing..." is displayed on this unit's display, and the pairing mode is enabled.

Now Pairing...

2. Enable (turn on) the BLUETOOTH function of the BLUETOOTH enabled device, then select this unit from amongst the devices displayed.
 - If a password is requested, enter "0000".
 - To connect another BLUETOOTH enabled device, press and hold BT AUDIO until "Now Pairing..." is displayed, then perform step 2 above. This unit can store the data of up to 8 paired devices.
 - The coverage area is 48 feet (15 meters). Note that connection is not always guaranteed with all BLUETOOTH enabled devices.

Playing Back

1. When the unit is on, connect the BLUETOOTH enabled device.
2. The input selector of this unit will be automatically switched to "BT AUDIO".
3. Play music. Increase the volume of the BLUETOOTH enabled device to an appropriate level.
 - Due to the characteristics of BLUETOOTH wireless technology, the sound produced on this unit may slightly be behind the sound played on the BLUETOOTH enabled device.



Others

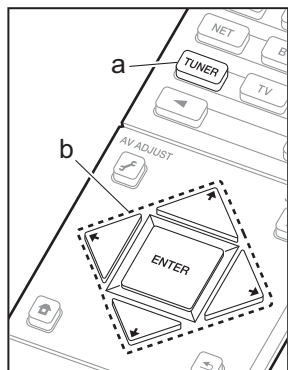

Listening To the Radio

1. Press TUNER (a) on the remote controller repeatedly to select either "AM" or "FM" on the display.
2. Press MODE (c) on the remote controller, so that the "TunMode: Auto" is displayed on the display.
3. When you press the \uparrow / \downarrow cursor (b) buttons on the remote controller, automatic tuning starts, and searching stops when a station is found. When tuned into a radio station, the "TUNED" indicator on the display lights.

You can preset up to 40 stations.

1. Tune into the AM/FM radio station you want to register.
2. Press +Fav (d) on the remote controller or +FAVORITE on the main unit so that the preset number on the display flashes.
3. While the preset number is flashing (about 8 seconds), repeatedly press the \leftarrow / \rightarrow cursor (b) buttons on the remote controller to select a number between 1 and 40.
4. Press +Fav (d) again on the remote controller or +FAVORITE on the main unit to register the station. When registered, the preset number stops flashing. To select a preset radio station, press the \leftarrow / \rightarrow cursor (b) buttons on the remote controller.
 - To delete a preset station, press the \leftarrow / \rightarrow cursor (b) buttons on the remote controller to select the preset number you want to delete, press +Fav (d) on the remote controller or +FAVORITE on the main unit and then press CLEAR (e) while the preset number is flashing. When deleted, the number on the display goes off.

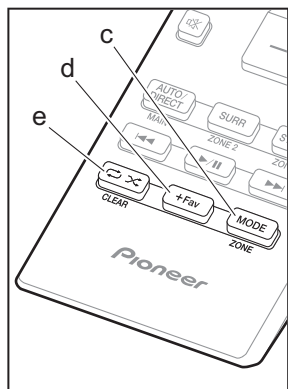

Frequency step setting

Press the HOME button on the remote controller to select "System Setup" – "Miscellaneous" – "Tuner" – "AM/FM Frequency Step" or "AM Frequency Step" and select the frequency step for your area. Note that when this setting is changed, all radio presets are deleted.

AV Adjust

By pressing the AV ADJUST button on the remote controller during play, you can adjust frequently used settings, such as the sound quality, using on-screen menus. Select the item with the cursors of the remote controller and press ENTER to confirm your selection. To return to the previous screen, press BACK . Note that there is no display on the TV screen when the input selector is "CD", "TV", "PHONO", "FM", or "AM", so follow the main unit's display while doing the operations.

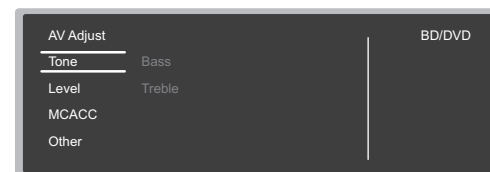

- You can adjust the sound quality with "Tone". "Other" includes settings such as "Sound Delay" that allows you to adjust the audio delay when the video is behind the audio, "Sound Retriever" that provides better sound quality for compressed audio.



Home

When you press on the remote controller, the Home is displayed and you can make settings in the various menus. Select the item with the cursors of the remote controller and press ENTER to confirm your selection. To return to the previous screen, press .

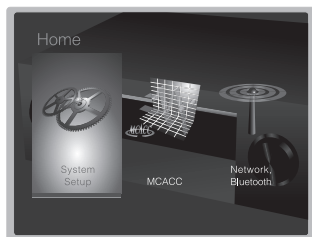

"System Setup": Advanced settings to provide you with an even better experience.

"MCACC": Setup the speakers automatically or make desired changes to the equalizer.

"Network/Bluetooth": Make Wi-Fi connection settings or settings related to BLUETOOTH.

When the unit is operating erratically (Resetting this unit)

Restarting the unit may help it operate more smoothly. To restart the unit, turn it to standby, and then press STANDBY/ON on the main unit for at least 5 seconds. (The unit's settings will be maintained.) If there is no improvement even after the unit is restarted, try disconnecting and reconnecting the power cords of the unit and connected equipment. When there is still no improvement, resetting the unit to the status at the time of shipment may solve the problem. If you reset the unit status, your preferences will be reset to the defaults. Note them down before the operation below.

How to reset the unit

1. While holding down AUTO/DIRECT on the main unit, press STANDBY/ON on the main unit.
2. "Clear" appears on the display and the unit returns to standby. Do not unplug the power cord until "Clear" disappears from the display.

To reset the remote controller, while holding down MODE, press until the remote indicator flash twice (about 3 seconds).

Front Panel

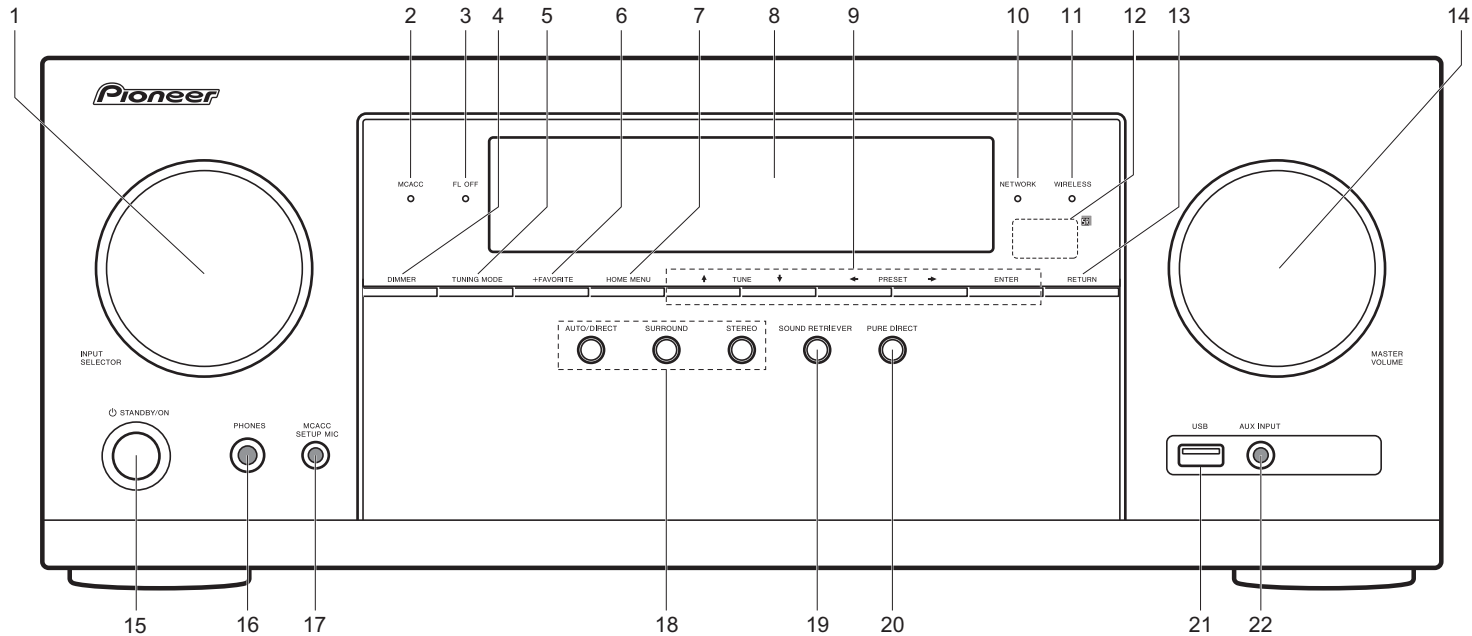

1. INPUT SELECTOR dial: Switch the input to be played.
2. MCACC indicator: This lights when you have enabled the speaker calibration made with MCACC.
3. FL OFF indicator: This lights when you have pressed DIMMER repeatedly to turn the display off.
4. DIMMER button: Switches the brightness of the display.
5. TUNING MODE button: Switches the tuning mode.
6. +FAVORITE button: Registers a radio station.
7. HOME MENU button: Displays the Home.
8. Display (→P20)
9. Cursor buttons (▲TUNE▼ / ◀PRESET▶ button) and ENTER button: Select the item with the cursors and press ENTER to confirm your selection. When using the TUNER, select the frequency with ▲TUNE▼, or select preset stations with ◀PRESET▶.
10. NETWORK indicator: When the power of the unit is on, this lights when "NET" is selected with the input selector and the unit is connected to the network. If the unit is in standby mode, this lights when functions such as HDMI CEC and network standby are enabled.
11. WIRELESS indicator: Lights when the unit is connected to the wireless network.
12. Remote control sensor
13. RETURN button: Returns the display to the previous state.
14. MASTER VOLUME: Allows you to adjust the volume.
15. ⏻ STANDBY/ON button: Turns the unit on or into standby mode.
16. PHONES jack: Stereo headphones with a standard plug (1/4 inch or ø6.3 mm) are connected.
17. MCACC SETUP MIC jack: The supplied speaker setup microphone is connected.
18. Listening mode button: Select the listening mode.
19. SOUND RETRIEVER button: Turns on/off the Sound Retriever function that provides better sound quality for compressed audio.
20. PURE DIRECT button: Switches to the Pure Direct mode.
21. USB port: A USB storage device is connected so that music files stored in it can be played. You can also supply power (5V/1A) to USB devices with a USB cable.
22. AUX INPUT jack: You can play the audio from an external player by connecting using a stereo mini plug cable.



Rear Panel

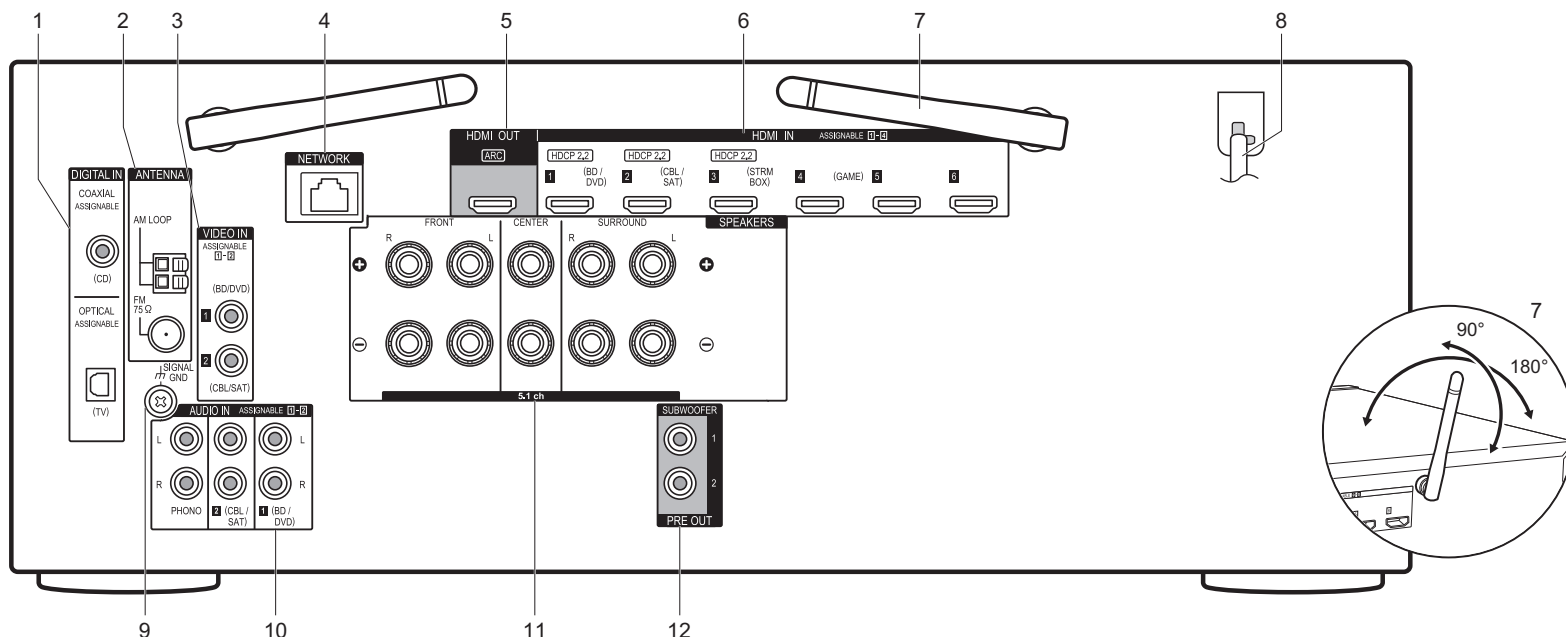

1. DIGITAL IN OPTICAL/COAXIAL jacks: Input TV or AV component digital audio signals with a digital optical cable or digital coaxial cable.
2. ANTENNA AM LOOP/FM 75Ω terminal: The supplied antennas are connected.
3. VIDEO IN jacks: Input the AV component video signals with an analog video cable.
4. NETWORK port: Connect to the network with an Ethernet cable.
5. HDMI OUT jacks: Transmit video signals and audio signals with a HDMI cable connected to a TV.
6. HDMI IN jacks: Transmit video signals and audio signals with a HDMI cable connected to an AV component.
7. Wireless antenna: Used for Wi-Fi connection or when using a BLUETOOTH enabled device. Adjust their

- angles according to the connection status.
8. Power cord
9. SIGNAL GND terminal: The ground wire of the turntable is connected.
10. AUDIO IN jacks: Input AV component audio signal with an analog audio cable.
11. SPEAKERS terminals: Connect speakers with speaker cables. (North American models are compatible with banana plugs.)
12. SUBWOOFER PRE OUT jack: Connect a powered subwoofer with a subwoofer cable. Up to two powered subwoofers can be connected. The same signal is output from each of the SUBWOOFER PRE OUT jacks.

Remote Controller

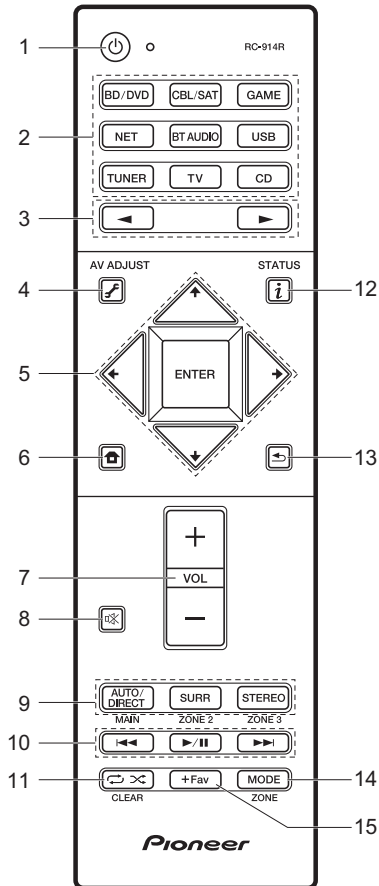

1. ⏻ button: Turns the unit on or into standby mode.
2. Input selector buttons: Select the input to be played. Use the buttons in 3 to select "STRM BOX", "AUX", or "PHONO".
3. ◀▶ button: Input source played switches each time you press one of these buttons.
4. 🔧 (AV ADJUST) button: You can perform common settings on the TV screen.
5. Cursor buttons and ENTER button: Select the item with the cursors and press ENTER to confirm your selection.
6. 🏠 button: Displays the Home.
7. Volume buttons: Allows you to adjust the volume. This button also cancels the muting.
8. 🔇 button: Temporarily mutes audio. Press again to cancel muting.
9. LISTENING MODE buttons: Allows you to select the listening mode.
10. Play button: Used for play operations when playing Music Server or USB.
11. ↺↻ button: Used for repeat or random play operations when playing Music Server or USB.
CLEAR button: Deletes all characters you have entered when entering text on the TV screen.
12. i (STATUS) button: Switches the information on the display.
13. 🏠 button: Returns the display to the previous state.
14. MODE button: Switches tuning to a station between automatic tuning and manual tuning.
15. +Fav button: Registers a radio station.

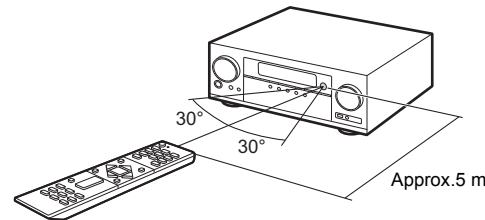

Display

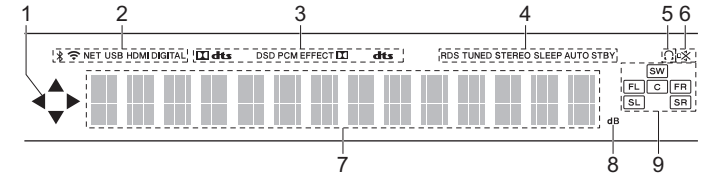

1. This may light when performing operations with the "NET", "USB" input selector.
2. Lights in the following conditions.
 - 📶: When connected by BLUETOOTH.
 - 📶: When connected by Wi-Fi.
 - NET: When "NET" is selected with the input selector and the unit is connected to the network. It will flash if the connection to the network is not correct.
 - USB: When "USB" is selected with the input selector and the unit is connected by USB and the USB device is selected. Flashes if the USB is not properly connected.
 - HDMI: When HDMI signals are input and the HDMI input is selected.
 - DIGITAL: When digital signals are input and the digital input is selected.
3. Lights according to the type of input digital audio signals and the listening mode.
4. Lights in the following conditions.
 - RDS (European, Australian and Asian models): Receiving RDS broadcasting.
 - TUNED: Receiving AM/FM radio.
 - STEREO: Receiving FM stereo.
 - SLEEP: When the sleep timer is set.
 - AUTO STBY: Auto Standby is on.
5. Lights when headphones are connected.
6. Flashes when muting is on.
7. Displays various information of the input signals.
8. Lights when adjusting the volume.
9. Speaker/Channel display: Displays the output channel that corresponds to the selected listening mode.

License and Trademark Information



Manufactured under license from Dolby Laboratories. Dolby, Pro Logic and the double-D symbol are trademarks of Dolby Laboratories.



For DTS patents, see <http://patents.dts.com>. Manufactured under license from DTS, Inc. DTS, the Symbol, DTS in combination with the Symbol, the DTS-HD logo, and DTS-HD Master Audio are registered trademarks or trademarks of DTS, Inc. in the United States and/or other countries. © DTS, Inc. All Rights Reserved.



The terms HDMI and HDMI High-Definition Multimedia Interface, and the HDMI Logo are trademarks or registered trademarks of HDMI Licensing LLC in the United States and other countries.



The Wi-Fi CERTIFIED Logo is a certification mark of the Wi-Fi Alliance®.



AirPlay, iPad, iPhone, and iPod touch are trademarks of Apple Inc., registered in the U.S. and other countries.

iPad Air and iPad mini are trademarks of Apple Inc.

"Made for iPod", "Made for iPhone" and "Made for iPad" mean that an electronic accessory has been designed to connect specifically to iPod, iPhone, or iPad, respectively, and has been certified by the developer to meet Apple performance standards. Apple is not responsible for the operation of this device or its compliance with safety and regulatory standards.

Please note that the use of this accessory with iPod, iPhone or iPad may affect wireless performance.

AirPlay works with iPhone, iPad, and iPod touch with iOS 4.3.3 or later, Mac with OS X Mountain Lion or later, and PC with iTunes 10.2.2 or later.

Apple, Apple TV and Safari are trademarks of Apple Inc., registered in the U.S. and other countries.



The BLUETOOTH® word mark and logos are registered trademarks owned by Bluetooth SIG, Inc. and any use of such marks by Onkyo Corporation is under license. Other trademarks and trade names are those of their respective

owners.

Onkyo Corporation does not guarantee BLUETOOTH compatibility between the AV receiver and all BLUETOOTH enabled devices.

For compatibility between the AV receiver and another device with BLUETOOTH technology, consult the device's documentation and dealer. In some countries, there may be restrictions on using BLUETOOTH devices. Check with your local authorities.

Onkyo Corporation ne garantit pas la compatibilité BLUETOOTH entre l'amplificateur AV et tous les appareils compatibles BLUETOOTH. Pour assurer la compatibilité entre l'amplificateur AV et un autre périphérique à technologie BLUETOOTH, consultez la documentation de l'appareil et le vendeur. Dans certains pays, il peut exister des restrictions sur l'utilisation d'appareils BLUETOOTH. Vérifiez auprès des autorités locales.

Onkyo Corporation no garantiza la compatibilidad BLUETOOTH entre el receptor de AV y todos los dispositivos con tecnología BLUETOOTH. Para obtener información sobre la compatibilidad entre el receptor de AV y otro dispositivo con tecnología BLUETOOTH, consulte al distribuidor y la documentación del dispositivo. En algunos países, es posible que el uso de dispositivos BLUETOOTH esté restringido. Consulte con las autoridades locales.

Onkyo Corporation non garantisce la compatibilità BLUETOOTH tra il ricevitore AV e tutti i dispositivi abilitati al BLUETOOTH.

Per verificare la compatibilità tra il ricevitore AV e un altro dispositivo dotato di tecnologia BLUETOOTH, consultare la documentazione del dispositivo in questione o contattare il rivenditore. In alcuni Paesi potrebbero esistere delle limitazioni per l'utilizzo di dispositivi BLUETOOTH. Verificare le condizioni con le autorità locali.

Onkyo Corporation garantiert nicht die BLUETOOTH Kompatibilität zwischen dem AV-Receiver und allen BLUETOOTH fähigen Geräten. Zur Kompatibilität zwischen dem AV-Receiver und einem anderen Gerät mit BLUETOOTH Technologie, schauen Sie in die Dokumentation des Geräts und fragen Sie den Händler. Es kann sein, dass es in einigen Ländern Beschränkungen zur Nutzung der BLUETOOTH Geräte gibt. Prüfen Sie das bei Ihren lokalen Behörden.

Onkyo Corporation garandeert niet de BLUETOOTH compatibiliteit tussen de AV-receiver en alle BLUETOOTH apparaten.

Raadpleeg voor compatibiliteit tussen de AV-receiver en een ander apparaat met BLUETOOTH technologie de documentatie van het apparaat of de verkoper. In sommige landen geldt mogelijk een beperking op het gebruik van BLUETOOTH apparatuur. Controleer de wetgeving in het land van gebruik.

Корпорация Onkyo не гарантирует совместимость по связи BLUETOOTH между AV-ресивером и всеми устройствами с функцией BLUETOOTH. Сведения о совместимости между AV-ресивером и другим устройством с функцией BLUETOOTH можно получить в документации на устройство и у его продавца. В некоторых странах могут действовать ограничения на использование устройств с функцией BLUETOOTH. Для получения информации по этому вопросу обращайтесь к представителям местной власти.

لا تضمن Onkyo وجود توافق في البلوتوث (BLUETOOTH) بين مُستقبل إشارات الصوت والصورة وجميع الأجهزة المزودة بالبلوتوث (BLUETOOTH). للتعرف على مدى التوافق بين مُستقبل إشارات الصوت والصورة وأي جهاز آخر مزود بالبلوتوث (BLUETOOTH)، قم بمراجعة الوثائق المرافقة للجهاز أو أسأل الوكيل. في بعض الدول، قد تكون هناك تقييدات على استخدام الأجهزة المزودة بالبلوتوث (BLUETOOTH). راجع السلطات المحلية.

PANDORA

PANDORA, the PANDORA logo, and the Pandora trade dress are trademarks or registered trademarks of Pandora Media, Inc. Used with permission.



Google Cast and the Google Cast badge are trademarks of Google inc.



The product with this logo is conformed to Hi-Res Audio standard defined by Japan Audio Society. This logo is used under license from Japan Audio Society.

This product is protected by certain intellectual property rights of Microsoft. Use or distribution of such technology outside of this product is prohibited without a license from Microsoft.

Windows and the Windows logo are trademarks of the Microsoft group of companies.

QR Code is a registered trademark of DENSO WAVE INCORPORATED.

"x.v.Color" and "x.v.Color" logo are trademarks of Sony Corporation.

DSD and the Direct Stream Digital logo are trademarks of Sony Corporation.

MPEG Layer-3 audio coding technology licensed from Fraunhofer IIS and Thomson.

"All other trademarks are the property of their respective owners."

"Toutes les autres marques commerciales sont la propriété de leurs détenteurs respectifs."

"El resto de marcas comerciales son propiedad de sus respectivos propietarios."

"Tutti gli altri marchi di fabbrica sono di proprietà dei rispettivi proprietari."

"Alle anderen Warenzeichen sind das Eigentum ihrer jeweiligen Eigentümer."

"Alle andere handelsmerken zijn eigendom van de desbetreffende rechthebbenden."

"Все товарные знаки являются собственностью соответствующих владельцев."

"جميع العلامات التجارية الأخرى مملوكة لأصحابها المعنيين."

DISCLAIMER

Through this device you are able to link to other services or websites which are not under the control of any company which has designed, manufactured or distributed/have distributed this device, and its affiliates (collectively, "Company"). We have no control over the nature, content and availability of those services. The inclusion of any links does not necessarily imply a recommendation or endorse the views expressed within them.

All information, content and services available through this device belong to third parties and are protected by copyright, patent, trademark and/or other intellectual property laws of applicable countries.

The information, content and services provided through this device are for your personal, noncommercial use only. Any information, content or services may not be used in any manner other than previously approved by the appropriate content owner or service provider.

You may not modify, copy, republish, translate, exploit, create derivative works, upload, post, transmit, sell or distribute in any manner any information, content or services available through this device, unless expressly permitted by the appropriate copyright, patent, trademark and/or other intellectual property owner, including, without limitation, content owner or service provider.

THE CONTENT AND SERVICES AVAILABLE THROUGH THIS DEVICE ARE PROVIDED "AS IS".

COMPANY DOES NOT WARRANT INFORMATION, CONTENT OR SERVICES SO PROVIDED, EITHER EXPRESSLY OR IMPLIEDLY, FOR ANY PURPOSE.

COMPANY EXPRESSLY DISCLAIMS ANY WARRANTIES, EXPRESS OR IMPLIED, INCLUDING BUT NOT LIMITED TO, WARRANTIES OF TITLE, NON-INFRINGEMENT, MERCHANTABILITY OR FITNESS FOR A PARTICULAR PURPOSE.

Company makes no representation or warranty of any kind, express or implied, about the completeness, accuracy, validity, legality, reliability, suitability or availability with respect to the information, content or services available through this device. Company shall not be liable, whether in contract or tort, including negligence and strict liability, for any direct, indirect, special, incidental or consequential damages or any other damages arising out of, or in connection with, any information contained in, or as a result of the use of any content or service by you or any third party, even if Company has been advised of the possibility of such damages, nor shall Company be liable for any third party claims against users of this device or any third party.

In no event shall Company be responsible nor liable for, without limiting the generality of the foregoing, any interruption or suspension of any information, content or service available through this device. Company is neither responsible nor liable for customer service related to the information, content and services available through this device. Any question or request for service relating to the information, content or services should be made directly to the appropriate content owners and services providers.

Pioneer

2-3-12 Yaesu, Chuo-ku, Tokyo 104-0028 JAPAN

<U.S.A.>

18 PARK WAY, UPPER SADDLE RIVER, NEW JERSEY 07458, U.S.A.

Tel: 1-201-785-2600 Tel: 1-844-679-5350

<Germany>

Hanns-Martin-Schleyer-Straße 35, 47877 Willich, Germany

Tel: +49(0)2154 913222

<UK>

Anteros Building, Odyssey Business Park, West End Road, South Ruislip,
Middlesex, HA4 6QQ United Kingdom

Tel: +44(0)208 836 3612

<France>

6, Avenue de Marais F - 95816 Argenteuil Cedex FRANCE

Tel: +33(0)969 368 050

Корпорация О энд Пи

2-3-12, Яэсу, Чуо-ку, г. Токио, 104-0028, ЯПОНИЯ

Register your product on

<http://www.pioneerelectronics.com> (US)

<http://www.pioneerelectronics.ca> (Canada)

<http://www.pioneer.eu> (Europe)

© 2016 Onkyo & Pioneer Corporation. All rights reserved.

© 2016 Onkyo & Pioneer Corporation. Tous droits de reproduction et de traduction réservés.

"Pioneer" is a trademark of Pioneer Corporation, and is used under license.

Printed in Malaysia / Imprimé en Malaisie / Напечатано в Малайзии

SN 29402183

F1601-0



* 2 9 4 0 2 1 8 3 *

Advanced Manual

VSX-831 AV Receiver

Specifications

General Specifications.....	2
About HDMI.....	4

Settings

System Setup.....	5
MCACC.....	17
Network/Bluetooth.....	20
AV Adjust.....	23
Firmware Update.....	25

Listening Modes

Selecting Listening Modes.....	28
Listening Mode Effects.....	29
Selectable Listening Modes.....	31

Playback Function

AM/FM radio.....	36
USB Storage Device.....	38
Internet Radio.....	40
Spotify.....	42
Music Server.....	43

Troubleshooting	46
------------------------------	-----------

Appendix	51
-----------------------	-----------

[The Basic Manual](#) includes information needed when starting up and also instructions for frequently used operations. [The Advanced Manual](#) has more detailed information and advanced settings.

General Specifications

■ Amplifier Section

Rated Output Power (FTC) (North American)

With 8 ohm loads, both channels driven, from 20-20,000 Hz; rated 80 watts per channel minimum RMS power, with no more than 0.08% total harmonic distortion from 250 milliwatts to rated output.

Surround Mode Output Power (*)

(6 ohms, 1 kHz THD 0.9%) 140 W per channel

* Reference output for each speakers.

Depending on the source and the listening mode settings, there may be no sound output.

Rated Output Power (IEC) (Others)

5 ch × 130 W at 6 ohms, 1 kHz, 1 ch driven of 1% THD

Maximum Effective Output Power (JEITA) (Asian and Australian)

5 ch × 160 W at 6 ohms, 1 kHz, 1 ch driven of 10% THD

Dynamic Power (*)

* IEC60268-Short-term maximum output power

160 W (3 Ω, Front)

125 W (4 Ω, Front)

85 W (8 Ω, Front)

THD+N (Total Harmonic Distortion+Noise)

0.08% (20 Hz - 20,000 Hz, half power)

Input Sensitivity and Impedance (1 kHz 100 W/8 Ω)

200 mV/47 kΩ (LINE (Unbalance))

3.5 mV/47 kΩ (PHONO MM)

Rated RCA Output Level and Impedance

1 V/470 Ω (SUBWOOFER PRE OUT)

Phono Overload

70 mV (MM 1 kHz 0.5%)

Frequency Response

10 Hz - 100 kHz/+1 dB, -3 dB (Pure Direct)

Tone Control Characteristics

±10 dB, 90 Hz (BASS)

±10 dB, 7.5 kHz (TREBLE)

Signal to Noise Ratio

106 dB (IHF-A, LINE IN, SP OUT)

80 dB (IHF-A, PHONO IN, SP OUT)

Speaker Impedance

6 Ω - 16 Ω

Headphone Output Impedance

330 Ω

Headphone Rated Output

85 mW (32 Ω, 1 kHz, 10% THD)

■ Video Section

Signal level

1 Vp-p/75 Ω (Composite Video)

■ Tuner Section

FM Tuning Frequency Range

87.5 MHz - 107.9 MHz (North American)

87.5 MHz - 108.0 MHz, RDS (Others)

AM Tuning Frequency Range

530 kHz - 1710 kHz (North American)

522/530 kHz - 1611/1710 kHz (Others)

Preset Channel

40

■ Network Section

Ethernet LAN

10BASE-T/100BASE-TX

Wireless LAN

IEEE 802.11 a/b/g/n standard

(Wi-Fi® standard)

5 GHz/2.4 GHz band

■ BLUETOOTH Section

Communication system

BLUETOOTH Specification version 4.1+LE

Frequency band

2.4 GHz band

Modulation method

FHSS (Freq Hopping Spread Spectrum)

Compatible BLUETOOTH profiles

A2DP 1.2

AVRCP 1.3

HOGP-Host (Client)

HOGP-HID Device (Server)

HID Service (HIDS)

Supported Codecs

SBC

AAC

Transmission range (A2DP)

20 Hz - 20 kHz (Sampling frequency 44.1 kHz)

Maximum communication range

Line of sight approx. 15 m (*)

* The actual range will vary depending on factors such as obstacles between devices, magnetic fields around a microwave oven, static electricity, cordless phone, reception sensitivity, antenna's performance, operating system, software application, etc.

■ General

Power Supply

AC 120 V, 60 Hz (North American)

AC 220 - 240 V, 50/60 Hz (Others)

Power Consumption

380 W (North American)

390 W (Others)

0.1 W (Stand-by, North American)

0.15 W (Stand-by, Others)

45 W (No-sound)

4.9 W (HDMI Standby Through, North American)

5.1 W (HDMI Standby Through, Others)

2.4 W (Network Standby)

Dimensions (W × H × D)

435 mm × 173 mm × 370.5 mm

17-1/8" × 6-13/16" × 14-9/16"

Weight

9.0 kg (19.8 lbs.) (North American)

9.2 kg (20.3 lbs.) (Others)

■ HDMI

Input

IN1 (BD/DVD, HDCP2.2), IN2 (CBL/SAT, HDCP2.2),
IN3 (STRM BOX, HDCP2.2), IN4 (GAME), IN5, IN6

Output

OUT

Supported

Deep Color, x.v.Color™, LipSync, Audio Return
Channel, 3D, 4K 60Hz, CEC, Extended Colorimetry
(sYCC601, Adobe RGB, Adobe YCC601), Content
Type, HDR

Audio Format

Dolby TrueHD, Dolby Digital, Dolby Digital Plus,
DTS, DTS-HD Master Audio, DTS-HD High
Resolution Audio, DTS 96/24, DTS-HD Express,
DSD, PCM

Maximum Video Resolution

4k 60 Hz (YCbCr 4:4:4)

■ Video Inputs

Composite

IN1 (BD/DVD), IN2 (CBL/SAT)

■ Compatible input resolutions

HDMI input

4K, 1080p/24, 1080p, 1080i, 720p, 480p/576p

Composite input

480i/576i

- The output from the HDMI OUT jack to the TV is the same resolution as the input. When using a TV that supports 4K, 1080p HDMI video signals can also be output as 4K.

■ Audio Inputs

Digital

OPTICAL (TV)
COAXIAL (CD)

Analog

BD/DVD, CBL/SAT, PHONO, AUX (front)

■ Audio Outputs

Analog

2 SUBWOOFER PRE OUT

Speaker Outputs

FRONT L/R, CENTER, SURROUND L/R
(North American models are banana plug ready)

Phones

PHONES (Front, ø 6.3 mm, 1/4")

■ Others

Setup Mic : 1 (Front)

USB : 1 (Ver. 2.0, 5 V/1 A)

Ethernet : 1

■ Power consumption in standby mode

- In the following cases, the power consumption in standby mode may reach up to a maximum of 12 W:
 - When "Network Standby" is set to "On"
 - When "HDMI CEC" is set to "On"
 - When "HDMI Standby Through" is set to other than "Off"
 - When "Bluetooth Wakeup" is set to "On"
 - When "USB Power Out at Standby" is set to "On"

Specifications and features are subject to change without notice.

About HDMI

Compatible functions

HDMI (High Definition Multimedia Interface) is a digital interface standard for connecting TVs, projectors, Blu-ray Disc/DVD players, set-top boxes, and other video components. Until now, several separate video and audio cables have been required to connect AV components. With HDMI, a single cable can carry control signals, digital video, and digital audio (2 ch PCM, multichannel digital audio, and multichannel PCM).

HDMI CEC functionality:

By connecting devices and HDMI cables that comply with the CEC (Consumer Electronics Control) specification of the HDMI standard, a variety of linked operation become possible between devices. You can enjoy features such as linking input switching with the input selector and players, control volume using the remote controller of the TV, and automatically switching this unit to standby when the TV is turned off.

The unit is designed to link with products that comply with the CEC standard, and that linked operation is not always guaranteed with all CEC devices. For linked functions to work properly, do not connect more CEC-compliant components than the quantities specified below, to the HDMI jack.

- Blu-ray Disc/DVD players: up to 3 units
- Blu-ray Disc/DVD recorders: up to 3 units
- Cable TV tuner, terrestrial digital tuner, and satellite broadcasting tuner: up to 4 units

Operation has been confirmed on the following devices from other manufacturers: (As of February 2016)

Toshiba brand televisions; Sharp brand televisions; Toshiba brand players and recorders; Sharp brand players and recorders (when used with a Sharp brand television)

ARC (Audio Return Channel) :

By connection a TV that supports ARC with a single HDMI cable, you can not only output the audio and video from this unit to the TV, but also input the audio from the TV to this unit.

HDMI Standby Through:

Even if this unit is in standby, the input signals from AV components are transmitted to the TV.

Deep Color:

By connecting devices supporting Deep Color, video signals input from the devices can be reproduced on the TV with even more colors.

x.v.Color™:

This technology realizes even more realistic colors by broadening the color gamut.

3D:

You can transmit 3D video signals from AV components to the TV.

4K:

This unit supports 4K (3840×2160p) and 4K SMPTE (4096×2160p) video signals.

LipSync:

This setting automatically corrects any desynchronization between the video and audio signals based on data from the HDMI LipSync compatible TV.

Copyright Protection:

The unit supports Revision 1.4 and Revision 2.2 (HDMI OUT and HDMI IN1 to 3 only) of the HDCP (High-bandwidth Digital Content Protection), a copy-protection system for digital video signals. Other devices connected to the unit must also support HDCP.

Supported Audio Formats

2 ch linear PCM:

32 kHz, 44.1 kHz, 48 kHz, 88.2 kHz, 96 kHz, 176.4 kHz, 192 kHz, 16/20/24 bit

Multi-channel linear PCM:

Maximum 5.1 channels, 32 kHz, 44.1 kHz, 48 kHz, 88.2 kHz, 96 kHz, 176.4 kHz, 192 kHz, 16/20/24 bit

Bitstream:

Dolby Digital, Dolby Digital Plus, Dolby TrueHD, DTS, DTS-HD High Resolution Audio, DTS-HD Master Audio

DSD:

Supported sampling rates: 2.8 MHz

Your Blu-ray Disc/DVD player must also support HDMI output of the above audio formats.

Supported resolutions

HDMI IN1 to IN3:

- Copyright protection technology: HDCP1.4/HDCP2.2
- Color space (Color Depth):
 - 720 × 480i 60Hz, 720 × 576i 50Hz, 720 × 480p 60Hz, 720 × 576p 50Hz, 1920 × 1080i 50/60Hz, 1280 × 720p 24/25/30/50/60Hz, 1680 × 720p 24/25/30/50/60Hz, 1920 × 1080p 24/25/30/50/60Hz, 2560 × 1080p 24/25/30/50/60Hz, 4K (3840 × 2160p) 24/25/30Hz, 4K SMPTE (4096 × 2160p) 24/25/30Hz : RGB/YCbCr4:4:4 (8/10/12 bit), YCbCr4:2:2 (12 bit)
 - 4K (3840 × 2160p) 50/60Hz, 4K SMPTE (4096 × 2160p) 50/60Hz : RGB/YCbCr4:4:4 (8 bit), YCbCr4:2:2 (12 bit), YCbCr4:2:0 (8/10/12 bit)

HDMI IN4 to IN6:

- Copyright protection technology: HDCP1.4
- Color space (Color Depth):
 - 720 × 480i 60Hz, 720 × 576i 50Hz, 720 × 480p 60Hz, 720 × 576p 50Hz, 1920 × 1080i 50/60Hz, 1280 × 720p 24/25/30/50/60Hz, 1680 × 720p 24/25/30/50/60Hz, 1920 × 1080p 24/25/30/50/60Hz, 2560 × 1080p 24/25/30/50/60Hz : RGB/YCbCr4:4:4 (8/10/12 bit), YCbCr4:2:2 (12 bit)
 - 4K (3840 × 2160p) 24/25/30Hz, 4K SMPTE (4096 × 2160p) 24/25/30Hz : RGB/YCbCr4:4:4 (8 bit), YCbCr4:2:2 (12 bit)
 - 4K (3840 × 2160p) 50/60Hz, 4K SMPTE (4096 × 2160p) 50/60Hz : YCbCr4:2:0 (8 bit)

System Setup

The unit allows you to configure advanced settings to provide you with an even better experience.

Operation:

Use the on-screen displays (OSD) that appear on the TV to make the settings. Press **Home** on the remote controller to display the Home screen, then select System Setup with the cursors on the remote controller and press ENTER.

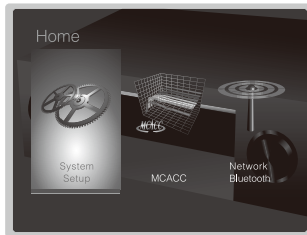

Select the item with the cursor **▲/▼/◀/▶** buttons of the remote controller and press ENTER to confirm your selection.

Use the cursors **◀/▶** to change the default values.

- To return to the previous screen, press **◀**.
- To exit the settings, press **Home**.

Input/Output Assign

Make settings related to output to the TV, change the settings for jack allocations to the various input selectors, and set the feature for displaying operations on the TV (OSD), etc.

■ TV Out/OSD

Setting Item	Default Value	Setting Details
1080p -> 4K Upscaling	Off	When using a TV that supports 4K, video signals input at 1080p can be automatically upscaled to 4K for output. "Off": Do not use this function "Auto": Use this function • Select "Off" if your TV does not support 4K.
Super Resolution	(2)	When you have set "1080p -> 4K Upscaling" to "Auto", you can select the degree of video signal correction from "Off" and between "1" (weak) and "3" (strong).
OSD Language	English	Select the on-screen display language. (North American models) English, German, French, Spanish, Italian, Dutch, Swedish (European, Australian and Asian models) English, German, French, Spanish, Italian, Dutch, Swedish, Russian, Chinese.
Impose OSD	On	Set whether or not to display the information on the TV when the volume is adjusted or input is changed, for example. "On": OSD displayed on the TV. "Off": OSD not displayed on the TV. • OSD may not be displayed depending on the input signal even if "On" is selected. If the operation screen is not displayed, change the resolution of the connected device.
Screen Saver	3 minutes	Set the time to start the screen saver. Select a value from "3 minutes", "5 minutes", "10 minutes" and "Off".

■ **HDMI Input**

You can change input assignment between the input selectors and HDMI IN jacks.

Setting Item	Default Value	Setting Details
BD/DVD	HDMI 1 (HDCP 2.2)	"HDMI 1 (HDCP 2.2)" to "HDMI 4": Assign a desired HDMI IN jack to the BD/DVD input selector. If you do not assign a jack, select "-----". To select an HDMI IN jack already assigned to another input selector, change the input selector setting to "-----" first.
CBL/SAT	HDMI 2 (HDCP 2.2)	"HDMI 1 (HDCP 2.2)" to "HDMI 4": Assign a desired HDMI IN jack to the CBL/SAT input selector. If you do not assign a jack, select "-----". To select an HDMI IN jack already assigned to another input selector, change the input selector setting to "-----" first.
GAME	HDMI 4	"HDMI 1 (HDCP 2.2)" to "HDMI 4": Assign a desired HDMI IN jack to the GAME input selector. If you do not assign a jack, select "-----". To select an HDMI IN jack already assigned to another input selector, change the input selector setting to "-----" first.
STRM BOX	HDMI 3 (HDCP 2.2)	"HDMI 1 (HDCP 2.2)" to "HDMI 4": Assign a desired HDMI IN jack to the STRM BOX input selector. If you do not assign a jack, select "-----". To select an HDMI IN jack already assigned to another input selector, change the input selector setting to "-----" first.

■ **Video Input**

You can change input assignment between the input selectors and the VIDEO IN 1 and 2 jacks. If you do not assign a jack, select "-----".

Setting Item	Default Value	Setting Details
BD/DVD	VIDEO 1	"VIDEO 1", "VIDEO 2": Assign a desired VIDEO IN jack to the BD/DVD input selector.
CBL/SAT	VIDEO 2	"VIDEO 1", "VIDEO 2": Assign a desired VIDEO IN jack to the CBL/SAT input selector.
GAME	-----	"VIDEO 1", "VIDEO 2": Assign a desired VIDEO IN jack to the GAME input selector.
STRM BOX	-----	"VIDEO 1", "VIDEO 2": Assign a desired VIDEO IN jack to the STRM BOX input selector.

■ Digital Audio Input

You can change input assignment between the input selectors and DIGITAL IN COAXIAL/OPTICAL jacks. If you do not assign a jack, select "-----".

Setting Item	Default Value	Setting Details
BD/DVD	-----	"COAXIAL", "OPTICAL ": Assign a desired DIGITAL IN jack to the BD/DVD input selector.
CBL/SAT	-----	"COAXIAL", "OPTICAL ": Assign a desired DIGITAL IN jack to the CBL/SAT input selector.
GAME	-----	"COAXIAL", "OPTICAL ": Assign a desired DIGITAL IN jack to the GAME input selector.
STRM BOX	-----	"COAXIAL", "OPTICAL ": Assign a desired DIGITAL IN jack to the STRM BOX input selector.
CD	COAXIAL	"COAXIAL", "OPTICAL ": Assign a desired DIGITAL IN jack to the CD input selector.
TV	OPTICAL	"COAXIAL", "OPTICAL ": Assign a desired DIGITAL IN jack to the TV input selector.

- Supported sampling rates for PCM signals (stereo, mono) from a digital input are 32kHz, 44.1kHz, 48kHz, 88.2kHz, 96kHz/16bit, 20bit, and 24bit.

■ Analog Audio Input

You can change input assignment between the input selectors and AUDIO IN jacks. If you do not assign a jack, select "-----".

Setting Item	Default Value	Setting Details
BD/DVD	AUDIO 1	"AUDIO 1" to "AUDIO 2": Assign a desired AUDIO IN jack to the BD/DVD input selector.
CBL/SAT	AUDIO 2	"AUDIO 1" to "AUDIO 2": Assign a desired AUDIO IN jack to the CBL/SAT input selector.
GAME	-----	"AUDIO 1" to "AUDIO 2": Assign a desired AUDIO IN jack to the GAME input selector.
STRM BOX	-----	"AUDIO 1" to "AUDIO 2": Assign a desired AUDIO IN jack to the STRM BOX input selector.
CD	-----	"AUDIO 1" to "AUDIO 2": Assign a desired AUDIO IN jack to the CD input selector.
TV	-----	"AUDIO 1" to "AUDIO 2": Assign a desired AUDIO IN jack to the TV input selector.

■ Input Skip

You can skip inputs to which nothing is connected when selecting them with the INPUT SELECTOR dial on the main unit or with the ◀/▶ input selectors on the remote controller.

Setting Item	Default Value	Setting Details
BD/DVD	Use	Set whether to skip the BD/DVD input selector. Select "Skip" to skip this input.
CBL/SAT	Use	Set whether to skip the CBL/SAT input selector. Select "Skip" to skip this input.
GAME	Use	Set whether to skip the GAME input selector. Select "Skip" to skip this input.
STRM BOX	Use	Set whether to skip the STRM BOX input selector. Select "Skip" to skip this input.
HDMI 5	Use	Set whether to skip the HDMI 5 input selector. Select "Skip" to skip this input.
HDMI 6	Use	Set whether to skip the HDMI 6 input selector. Select "Skip" to skip this input.
AUX	Use	Set whether to skip the AUX input selector. Select "Skip" to skip this input.
CD	Use	Set whether to skip the CD input selector. Select "Skip" to skip this input.
TV	Use	Set whether to skip the TV input selector. Select "Skip" to skip this input.
PHONO	Use	Set whether to skip the PHONO input selector. Select "Skip" to skip this input.
TUNER	Use	Set whether to skip the TUNER input selector. Select "Skip" to skip this input.
NET	Use	Set whether to skip the NET input selector. Select "Skip" to skip this input.
USB	Use	Set whether to skip the USB input selector. Select "Skip" to skip this input.
BT AUDIO	Use	Set whether to skip the BT AUDIO input selector. Select "Skip" to skip this input.

Speaker

You can make changes to the connection environment of the speakers and change the volume level. Settings are automatically configured if you use Full Auto MCACC. This setting cannot be selected if headphones are connected or audio is output from the speakers of the TV.

■ Configuration

Setting Item	Default Value	Setting Details
Speaker Channels	5.1 ch	Select "2.1 ch", "3.1 ch", "4.1 ch" or "5.1 ch" to suit the number of speaker channels connected.
Subwoofer	Yes	Set whether a subwoofer is connected or not. "Yes": When subwoofer is connected "No": When subwoofer is not connected

■ Crossover

Setting Item	Default Value	Setting Details
Front	Small	<p>Set the low range capabilities for each channel by setting either small or large.</p> <p>"Small": For small speakers whose low range capabilities may be limited</p> <p>"Large": For full-range speakers with sufficient low range capabilities</p> <ul style="list-style-type: none"> • If "System Setup" - "Speaker" - "Configuration" - "Subwoofer" is set to "No", "Front" will be fixed to "Large" and the low pitched range of the other channels will be output from the front speakers. Refer to the instruction manual of your speakers to make the setting.
Center	Small	<p>Set the low range capabilities for each channel by setting either small or large.</p> <p>"Small": For small speakers whose low range capabilities may be limited</p> <p>"Large": For full-range speakers with sufficient low range capabilities</p> <ul style="list-style-type: none"> • When "Front" is set to "Small", this is set to "Small". • If an item cannot be selected even though connection is correct, check that the settings in "System Setup" - "Speaker" - "Configuration" - "Speaker Channels" matches the number of connected channels.
Surround	Small	<p>Set the low range capabilities for each channel by setting either small or large.</p> <p>"Small": For small speakers whose low range capabilities may be limited</p> <p>"Large": For full-range speakers with sufficient low range capabilities</p> <ul style="list-style-type: none"> • When "Front" is set to "Small", this is set to "Small". • If an item cannot be selected even though connection is correct, check that the settings in "System Setup" - "Speaker" - "Configuration" - "Speaker Channels" matches the number of connected channels.

Setting Item	Default Value	Setting Details
Crossover	80Hz	<p>When there are speakers that have been set to "Small", set the Hz under which you would like other speakers to play bass, and also set Hz under which you would like the LFE (low frequency effect) to play the bass. The value from "50Hz" to "200Hz" can be set.</p>
Double Bass	Off	<p>This can be selected only when "System Setup" - "Speaker" - "Configuration" - "Subwoofer" is set to "Yes" and "Front" is set to "Large".</p> <p>Boost bass output by feeding bass sounds from the front left and right, and center speakers to the subwoofer.</p> <p>"On": Bass output will be boosted</p> <p>"Off": Bass output will not be boosted</p> <ul style="list-style-type: none"> • The setting will not automatically be configured even if you performed Full Auto MCACC.

■ Distance

Set the distance from each speaker to the listening position.

Setting Item	Default Value	Setting Details
Front Left	10.0ft/3.00m	Specify the distance between each speaker and the listening position.
Center	10.0ft/3.00m	Specify the distance between each speaker and the listening position.
Front Right	10.0ft/3.00m	Specify the distance between each speaker and the listening position.
Surround Right	10.0ft/3.00m	Specify the distance between each speaker and the listening position.
Surround Left	10.0ft/3.00m	Specify the distance between each speaker and the listening position.
Subwoofer	10.0ft/3.00m	Specify the distance between each speaker and the listening position.

- Default values vary depending on the regions.
- Distance units can be switched by pressing MODE on the remote controller. When the unit is set as feet, you can set between 0.1 ft and 30.0 ft in increments of 0.1ft. When the unit is set as meters, you can set between 0.03 m and 9.00 m in increments of 0.03 m.

■ Channel Level

Setting Item	Default Value	Setting Details
Front Left	0.0 dB	Select a value between "– 12.0 dB" and "+12.0 dB" (in 0.5 dB increments). A test tone will be output each time you change the value. Select the desired level.
Center	0.0 dB	Select a value between "– 12.0 dB" and "+12.0 dB" (in 0.5 dB increments). A test tone will be output each time you change the value. Select the desired level.
Front Right	0.0 dB	Select a value between "– 12.0 dB" and "+12.0 dB" (in 0.5 dB increments). A test tone will be output each time you change the value. Select the desired level.

Setting Item	Default Value	Setting Details
Surround Right	0.0 dB	Select a value between "– 12.0 dB" and "+12.0 dB" (in 0.5 dB increments). A test tone will be output each time you change the value. Select the desired level.
Surround Left	0.0 dB	Select a value between "– 12.0 dB" and "+12.0 dB" (in 0.5 dB increments). A test tone will be output each time you change the value. Select the desired level.
Subwoofer	0.0 dB	Select a value between "– 15.0 dB" and "+12.0 dB" (in 0.5 dB increments). A test tone will be output each time you change the value. Select the desired level.

Audio Adjust

Make advanced settings such as those related to multiplex audio or those related to the volume of this unit.

■ Dual Mono/Mono

Setting Item	Default Value	Setting Details
Dual Mono	Main	Set the audio channel or language to be output when playing multiplex audio or multilingual TV broadcasts etc. "Main": Main channel only "Sub": Sub channel only "Main/Sub": Main and sub channels will be output at the same time. • If multiplex audio is being played, "1+1" will be displayed when  on the remote controller is pressed.
Mono Input Channel	Left+Right	Set the input channel to use for playing any 2 ch digital source such as Dolby Digital, or 2 ch analog/PCM source in the Mono listening mode. "Left": Left channel only "Right": Right channel only "Left + Right": Left and right channels

■ Dolby

Setting Item	Default Value	Setting Details
Loudness Management	On	When playing Dolby TrueHD, enable the dialog normalization function which keeps the volume of dialog at a certain level. Note that when this setting is Off, the DRC function that allows you to enjoy surround at low volumes is fixed to off when playing Dolby Digital Plus/Dolby TrueHD. "On": Use this function "Off": Do not use this function

■ Volume

Setting Item	Default Value	Setting Details
Mute Level	-∞ dB	Set the volume lowered from the listening volume when muting is on. Select a value from "-∞ dB", "-40 dB", and "-20 dB".
Volume Limit	Off	Set the maximum value to avoid too high volume. Select "Off" or a value between "-32 dB" and "+17 dB".
Power On Level	Last	Set the volume level of when the power is turned on. Select a value from "Last" (volume before entering standby mode), "-∞ dB", and "-81.5 dB" to "+18.0 dB". • You cannot set a higher value than that of "Volume Limit".
Headphone Level	0.0 dB	Adjust the output level of the headphones. Select a value between "-12.0 dB" and "+12.0 dB".

Source

Make settings for input sources, such as volume difference adjustments for each input selector for the connected equipment.

■ Input Volume Absorber

Adjust the volume level difference between the devices connected to the unit. Select the input selector to configure.

Setting Item	Default Value	Setting Details
Input Volume Absorber	0.0 dB	Select a value between "-12.0 dB" and "+12.0 dB". Set a negative value if the volume of the target device is larger than the others and a positive value if smaller. To check the audio, start playback of the connected device.

■ Name Edit

Set an easy name to each input. The set name will be shown on the main unit display. Select the input selector to configure.

Setting Item	Default Value	Setting Details
Name Edit	Input name	<ol style="list-style-type: none"> Select a character or symbol with the cursors and press ENTER. Repeat it to input 10 or less characters. "A/a": Switches between upper and lower cases. (Pressing MODE on the remote controller also toggles between upper and lower cases) "←" "→": Moves the cursor to the arrow direction. "⊞": Removes a character on the left of the cursor. "␣": Enters a space. <ul style="list-style-type: none"> Pressing CLEAR on the remote controller will remove all the input characters. After inputting, select "OK" with the cursors and press ENTER. The input name will be saved.

- To name a preset radio station, press TUNER on the remote controller, select AM/FM and select the preset number.
- This cannot be set if the "NET" "USB" or "BT AUDIO" input is selected.

■ Audio Select

Select the priority for input selection when multiple audio sources are connected to one input selector, such as connections to both the "BD/DVD" HDMI IN jack and the "BD/DVD" AUDIO IN jack. The setting can be separately set to each input selector. Select the input selector to configure.

Setting Item	Default Value	Setting Details
Audio Select	BD/DVD: HDMI CBL/SAT: HDMI GAME: HDMI STRM BOX: HDMI CD: COAXIAL TV: OPTICAL PHONO: Analog	<p>"ARC": When giving priority to input signal from ARC compatible TV.</p> <ul style="list-style-type: none"> The setting can be selected only when "System Setup" - "Hardware" - "HDMI" - "Audio Return Channel" is set to "Auto" and also the "TV" input is selected. <p>"HDMI": When giving priority to input signal from HDMI IN jacks</p> <ul style="list-style-type: none"> The setting can be selected only when the input is assigned to the HDMI jack in the "System Setup" - "Input/Output Assign" - "HDMI Input" setting. <p>"COAXIAL": When giving priority to input signal from DIGITAL IN COAXIAL jacks</p> <ul style="list-style-type: none"> The setting can be selected only when the input is assigned to the COAXIAL jack in the "System Setup" - "Input/Output Assign" - "Digital Audio Input" setting. <p>"OPTICAL": When giving priority to input signal from DIGITAL IN OPTICAL jacks</p> <ul style="list-style-type: none"> The setting can be selected only when the input is assigned to the OPTICAL jack in the "System Setup" - "Input/Output Assign" - "Digital Audio Input" setting. <p>"Analog": To always output analog audio independently of the input signal</p> <ul style="list-style-type: none"> The setting can be selected only when the input is assigned to the AUDIO IN jack in the "System Setup" - "Input/Output Assign" - "Analog Audio Input" setting.

Setting Item	Default Value	Setting Details
Fixed PCM	Off	<p>Select whether to fix input signals to PCM (except multi-channel PCM) when you have selected "HDMI", "COAXIAL", or "OPTICAL" in the "Audio Select" setting. Set this item to "On" if noise is produced or truncation occurs at the beginning of a track when playing PCM sources. Select "Off" normally.</p> <ul style="list-style-type: none"> Changing "Audio Select" changes the setting to "Off".

- The setting cannot be changed when "TUNER", "NET", "USB", or "BT AUDIO" input is selected.

Hardware

Make settings related to the HDMI CEC, HDMI Standby Through, ARC features, settings related to power management of the unit, such as Auto Standby and Network Standby.

■ HDMI

Setting Item	Default Value	Setting Details
HDMI CEC	Off	<p>Setting to "On" enables the input selection link and other link functions with HDMI connected CEC compliant device.</p> <p>"On": Use this function "Off": Do not use this function</p> <p>When changing this setting, turn off and then on again the power of all connected components.</p> <ul style="list-style-type: none"> Depending on the TV set, a link may need to be configured on the TV. Setting to "On" and closing the on-screen menu displays the name of the CEC-compatible components and "CEC On" on the display. Power consumption in standby mode may increase if "On" is set. (Depending on the TV status, the unit will enter the normal standby mode.) If you operate the MASTER VOLUME dial on the main unit when this setting is "On" and audio is output from the TV speakers, audio will be output also from the speakers connected to the unit. If you want to output from only either of them, change the unit or TV settings, or reduce the volume of the unit. If abnormal operation occurs when you set the setting to "On", set it to "Off". When connecting a non-CEC compatible component, or when you are not sure whether it is compatible, set the setting to "Off".

Setting Item	Default Value	Setting Details
HDMI Standby Through	Off	<p>When this is set to anything other than "Off", you can play the video and audio of an HDMI connected player on the TV even if the unit is in standby mode. Only "Auto" and "Auto(Eco)" can be selected if "HDMI CEC" is set to "On". If you select anything else, set "HDMI CEC" to "Off".</p> <ul style="list-style-type: none"> Power consumption in standby mode increases if set to anything other than "Off". <p>"BD/DVD", "CBL/SAT", "GAME", "STRM BOX", "HDMI 5", "HDMI 6": For example, if you select "BD/DVD", you can play the equipment connected to the "BD/DVD" jack on the TV even if the unit is in standby mode. Select this setting if you have decided which player to use with this function.</p> <p>"Last": You can play the video and audio of the input selected immediately prior to the unit being switched to standby on the TV.</p> <p>"Auto", "Auto (Eco)": Select one of these settings when you have connected equipment that conforms to the CEC standard. You can play the video and audio of the input selected on the TV, irrespective of what input was selected immediately prior to the unit being switched to standby, using the CEC link function.</p> <ul style="list-style-type: none"> To play players on the TV that do not conform to the CEC standard, you will need to turn the unit on and switch to the relevant input. When using TV that complies with the CEC standard, you can reduce the power consumption in standby mode by selecting "Auto (Eco)".

Setting Item	Default Value	Setting Details
Audio TV Out	Off	<p>You can enjoy audio through the speakers of the TV while this unit is on.</p> <p>"On": Use this function "Off": Do not use this function</p> <ul style="list-style-type: none"> The setting is fixed to "Auto" if "HDMI CEC" is set to "On". If you change this setting, set "HDMI CEC" to "Off". Listening mode cannot be changed while "Audio TV Out" is set to "On" and audio is being output through the speakers of the TV. Depending on your TV set or input signal of the component, audio may not output through the speakers of the TV even if this setting is set to "On". In such case, audio is output from the speakers of the unit. If you operate the MASTER VOLUME dial on this unit when audio that is being input through this unit for output from the TV speakers, audio is output from this unit. If you do not want to output audio from the unit, change the unit or TV settings, or reduce the volume of the unit.
Audio Return Channel	(Auto) (*)	<p>You can enjoy sound of the HDMI connected ARC compatible TV through the speakers connected to the unit.</p> <p>* To use this function, set "HDMI CEC" to "On" in advance.</p> <p>"Auto": When enjoying the TV sound through the speakers connected to the unit "Off": When not using the ARC function</p>
Auto Delay	On	<p>This setting automatically corrects any desynchronization between the video and audio signals based on data from the HDMI LipSync compatible TV.</p> <p>"On": Automatic correction will be enabled "Off": Automatic correction will be disabled</p>

■ Power Management

Setting Item	Default Value	Setting Details
Sleep Timer	Off	Allows the unit to enter standby automatically when the specified time elapses. Select a value from "30 minutes", "60 minutes", and "90 minutes". "Off": Does not turn the unit to standby automatically
Auto Standby	On/Off	This setting places the unit on standby automatically after 20 minutes of inactivity without any video or audio input. (When "USB Power Out at Standby" or "Network Standby" is on, this becomes the HYBRID STANDBY mode which reduces the increase in power consumption to a minimum.) "On": The unit will automatically enter standby mode ("AUTO STBY" will light.) "Off": The unit will not automatically enter standby mode <ul style="list-style-type: none"> "Auto Standby" is displayed on the display and TV screen 30 seconds before the Auto Standby comes on.
Auto Standby in HDMI Standby Through	(Off)	Enable or disable "Auto Standby" while "HDMI Standby Through" is on. "On": The setting will be enabled "Off": The setting will be disabled <ul style="list-style-type: none"> This setting cannot be set to "On" if "Auto Standby" is set to "Off".
USB Power Out at Standby	Off	Devices connected to the USB port are supplied with electricity even when this unit is in standby mode when this function is "On". <ul style="list-style-type: none"> When using this feature, power consumption increases even when the unit is on standby, however, the increase in power consumption is kept to a minimum by automatically entering the HYBRID STANDBY mode, where only essential circuits are operating.

Setting Item	Default Value	Setting Details
Network Standby	On	When this feature is turned "On", you can turn on the power of the unit via the network using an application such as iControlAV5 that can control this unit. <ul style="list-style-type: none"> When "Network Standby" is used, the power consumption increases even when the unit is on standby. However, the increase in power consumption is kept to a minimum by automatically entering the HYBRID STANDBY mode, where only the essential circuit is operating. "Network Standby", which suppresses power consumption, may be disabled when the network connection is lost. Use the power button on the remote controller or main unit to turn the unit on if this happens.
Bluetooth Wakeup	Off	This function wakes up the unit on standby by connecting a BLUETOOTH enabled device. "On": Use this function "Off": Do not use this function <ul style="list-style-type: none"> Setting to "On" increases the power consumption even when the unit is on standby. However, the increase in power consumption is kept to a minimum by automatically entering the HYBRID STANDBY mode, where only the essential circuit is operating. This setting is fixed to "Off" if "Network/Bluetooth" - "Bluetooth" - "Auto Input Change" is set to "Off".

- Wait for a while if "Network Standby" and "Bluetooth Wakeup" cannot be selected. It will appear when the network feature is started.

Miscellaneous

Change the frequency step for the tuner, update the firmware, and perform Initial Setup, etc.

■ Tuner

Setting Item	Default Value	Setting Details
AM/FM Frequency Step (North American models)	10kHz/0.2MHz	Select a frequency step depending on your area of residence. Select "10kHz/0.2MHz" or "9kHz/0.05MHz". • When this setting is changed, all radio presets are deleted.
AM Frequency Step (European, Australian and Asian models)	9kHz	Select a frequency step depending on your area of residence. Select "10kHz" or "9kHz". • When this setting is changed, all radio presets are deleted.

■ Remote ID

Setting Item	Default Value	Setting Details
Remote ID	1	Select an ID for the unit's remote controller from "1", "2", and "3" to prevent interference between the unit and other Pioneer components that are installed in the same room. After changing the ID on the main unit, change the ID on the remote controller accordingly with the following procedure. While holding down MODE, press the following buttons for about 3 seconds. • To change the remote controller ID to "1": ◀◀ (The remote indicator flashes once.) • To change the remote controller ID to "2": ▶/ (The remote indicator flashes twice.) • To change the remote controller ID to "3": ▶▶ (The remote indicator flashes three times.)

■ Firmware Update

Setting Item	Default Value	Setting Details
Update Notice	Enable	Availability of a firmware update will be notified via network. "Enable": Notify updates "Disable": Do not notify updates
Version	-	The current firmware version will be displayed.
Update via NET	-	Press ENTER to select when you want to update the firmware via network. • You will not be able to select this setting if you do not have Internet access or there is nothing to update.
Update via USB	-	Press ENTER to select when you want to update the firmware via USB. • You will not be able to select this setting if a USB storage device is not connected or there is nothing to update in the USB storage device.

- Wait for a while if "Firmware Update" cannot be selected. It will appear when the network feature is started.

■ Initial Setup

You can make the initial setup from the setup menu.

- Wait for a while if "Initial Setup" cannot be selected. It will appear when the network feature is started.

■ Lock

Setting Item	Default Value	Setting Details
Setup Parameter	Unlocked	Lock the Setup menu to protect the settings. "Locked": The menu is locked. "Unlocked": The menu is unlocked.





MCACC

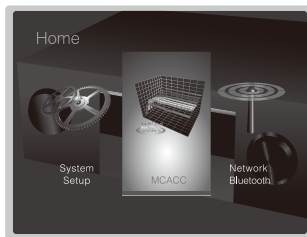

Setup the speakers automatically or make desired changes to the equalizer. You can also check the values set currently for each speaker setting.



Operation:

Use the on-screen displays (OSD) that appear on the TV to make the settings. Press  on the remote controller to display the Home screen, then select MCACC with the cursors on the remote controller and press ENTER.



Select the item with the cursor /// buttons of the remote controller and press ENTER to confirm your selection.

Use the cursors / to change the default values.

- To return to the previous screen, press .
- To exit the settings, press .

Full Auto MCACC

Place the supplied speaker setup microphone in the listening position, measure the test tones emitted by the speakers, then the unit automatically sets the optimum volume level for each speaker, the crossover frequencies, and the distance from the listening position. This also automatically adjusts the equalizers for the speakers and enables correction of distortion caused by the acoustic environment of the room.

- Calibration takes several minutes to be completed. The speakers emit the test tone at high volume during measurement, so be careful of your surroundings. Keep the room as quiet as possible during measurement. If the measurement is interrupted, turn off the household appliances.

1. Place the supplied speaker setup microphone in the listening position, and connect to the MCACC SETUP MIC jack on the main unit.

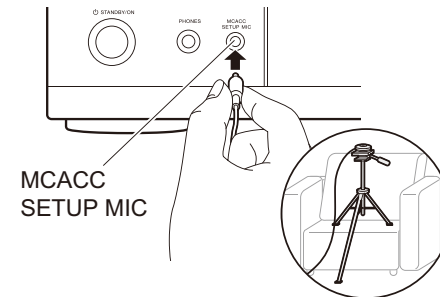

When putting the speaker setup microphone on a tripod, refer to the illustration when putting it in place.

2. Select the connected speaker configuration.



The image on the screen changes as you choose the number of channels in "Speaker Channels", so refer to it when performing the settings. Also use this screen to select

whether you have connected a subwoofer.

- If you have connected a subwoofer, check the power and volume of the subwoofer. The low frequencies played by the subwoofer may not be discernible, so set its volume to at least halfway.
3. Test tones are emitted by the speakers, and firstly the unit detects the speakers connected and the noise in the environment.
 4. After the results of the above measurements are displayed, select "Next", press ENTER on the remote controller, and the test tones are emitted again, and the unit automatically makes settings such as the optimum volume level and the crossover frequency.
 5. When the measurement is completed, the measurement result is displayed. Press the cursors ◀/▶ on the remote controller to check the settings. Press ENTER when "Save" is selected to save the settings.



6. Disconnect the speaker setup microphone.

Manual MCACC

■ EQ Adjust

If you perform Full Auto MCACC then settings are automatic, but you can also adjust the output volume of the range of each connected speaker to suit your own preferences. You can adjust the volume of the different sound ranges for each of the speakers. You can set three different equalizers in Preset 1 to 3. You can select up to 4 bands for the Subwoofer and 9 bands for all other speakers.

Setting Item	Default Value	Setting Details
Front Left	0 dB	After selecting the speaker frequency from between "63 Hz" and "16 kHz" with the cursors ◀/▶, adjust the volume of that frequency between "− 12.0 dB" and "+12.0 dB" with ▲/▼. <ul style="list-style-type: none"> • If an item cannot be selected even though connection is correct, check that the settings in "System Setup" - "Speaker" - "Configuration" - "Speaker Channels" matches the number of connected channels.
Center	0 dB	After selecting the speaker frequency from between "63 Hz" and "16 kHz" with the cursors ◀/▶, adjust the volume of that frequency between "− 12.0 dB" and "+12.0 dB" with ▲/▼. <ul style="list-style-type: none"> • If an item cannot be selected even though connection is correct, check that the settings in "System Setup" - "Speaker" - "Configuration" - "Speaker Channels" matches the number of connected channels.
Front Right	0 dB	After selecting the speaker frequency from between "63 Hz" and "16 kHz" with the cursors ◀/▶, adjust the volume of that frequency between "− 12.0 dB" and "+12.0 dB" with ▲/▼. <ul style="list-style-type: none"> • If an item cannot be selected even though connection is correct, check that the settings in "System Setup" - "Speaker" - "Configuration" - "Speaker Channels" matches the number of connected channels.

Setting Item	Default Value	Setting Details
Surround Right	0 dB	<p>After selecting the speaker frequency from between "63 Hz" and "16 kHz" with the cursors ◀/▶, adjust the volume of that frequency between "− 12.0 dB" and "+12.0 dB" with ▲/▼.</p> <ul style="list-style-type: none"> If an item cannot be selected even though connection is correct, check that the settings in "System Setup" - "Speaker" - "Configuration" - "Speaker Channels" matches the number of connected channels.
Surround Left	0 dB	<p>After selecting the speaker frequency from between "63 Hz" and "16 kHz" with the cursors ◀/▶, adjust the volume of that frequency between "− 12.0 dB" and "+12.0 dB" with ▲/▼.</p> <ul style="list-style-type: none"> If an item cannot be selected even though connection is correct, check that the settings in "System Setup" - "Speaker" - "Configuration" - "Speaker Channels" matches the number of connected channels.
Subwoofer	0 dB	<p>After selecting the speaker frequency from between "31 Hz" and "250 Hz" with the cursors ◀/▶, adjust the volume of that frequency between "− 12.0 dB" and "+12.0 dB" with ▲/▼.</p> <ul style="list-style-type: none"> This cannot be selected if "No" is set in "System Setup" - "Speaker" - "Configuration" - "Subwoofer".

- The result may not be as expected depending on the input source and listening mode setting.
- If you want to make the adjustments while listening to something, press  on the remote controller, and select the Preset you want to adjust in "AV Adjust" - "MCACC" - "Manual EQ Select" first.

MCACC Data Check

You can check the number of speaker channels connected and the content and values you have set for each of the speaker settings.

■ Speaker Setting

You can check the number of speaker channels connected and the large and small settings you have set for the low range reproduction capabilities for each of the speakers.

■ Channel Level

You can check the output level settings for each of the speakers.

■ Speaker Distance

You can check the distance from each speaker to the listening position.

■ Acoustic Calibration EQ

You can check the calibration values for the frequency characteristics of each speaker that were set in "Manual MCACC".

Network/Bluetooth

Make settings related to network connections and BLUETOOTH .

Operation:

Use the on-screen displays (OSD) that appear on the TV to make the settings.

Press **Home** on the remote controller to display the Home screen, select Network/Bluetooth with the cursors on the remote controller, then press ENTER.

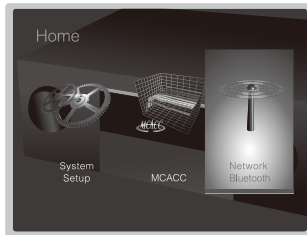

Select the item with the cursor **▲/▼/◀/▶** buttons of the remote controller and press ENTER to confirm your selection.

Use the cursors **◀/▶** to change the default values.

- To return to the previous screen, press **◀**.
- To exit the settings, press **Home**.

Network

- When LAN is configured with a DHCP, set "DHCP" to "Enable" to configure the setting automatically. ("Enable" is set by default.) To assign fixed IP addresses to each components, you must set "DHCP" to "Disable" and assign an address to this unit in "IP Address" as well as set information related to your LAN, such as Subnet Mask and Gateway.

Setting Item	Default Value	Setting Details
Wi-Fi	Off(Wired)	Connect the unit to network via wireless LAN router. "On": Wireless LAN connection "Off (Wired)": Wired LAN connection
Wi-Fi Setup	-	You can configure wireless LAN settings by pressing ENTER when "Start" is displayed.
Wi-Fi Status	-	The information of the connected access point will be displayed. "SSID": SSID of the connected access point. "Signal": Signal strength of the connected access point. "Status": Status of the connected access point.
MAC Address	-	This is the MAC address of this unit. This value is specific to the component and cannot be changed.
DHCP	Enable	"Enable": Auto configuration by DHCP "Disable": Manual configuration without DHCP <ul style="list-style-type: none"> • If selecting "Disable", you must set "IP Address", "Subnet Mask", "Gateway", and "DNS Server" manually.
IP Address	(0.0.0.0)	Displays/Sets the IP address.
Subnet Mask	(0.0.0.0)	Displays/Sets the subnet mask.
Gateway	(0.0.0.0)	Displays/Sets the gateway.
DNS Server	(0.0.0.0)	Displays/Sets the primary DNS server.
Proxy URL	-	Displays/Sets the proxy server URL.
Proxy Port	(8080)	Displays/Sets the proxy server port number when you enter "Proxy URL".

Setting Item	Default Value	Setting Details
Friendly Name	Pioneer VSX-831 XXX	<p>Change the device name for this unit which is shown on other devices connected to the network to an easily recognized name.</p> <ol style="list-style-type: none"> 1. Press ENTER to display the Edit screen. 2. Select a character or symbol with the cursors and press ENTER. Repeat it to input 31 or less characters. "A/a": Switches between upper and lower cases. (Pressing MODE on the remote controller also toggles between upper and lower cases.) "←" "→": Moves the cursor to the arrow direction. "⊞": Removes a character on the left of the cursor. "␣": Enters a space. <ul style="list-style-type: none"> • Pressing CLEAR on the remote controller will remove all the input characters. 3. After inputting, select "OK" with the cursors and press ENTER. The input name will be saved.

Setting Item	Default Value	Setting Details
AirPlay Password		<p>You can set a password of up to 31 characters so that only registered users can use AirPlay®.</p> <ol style="list-style-type: none"> 1. Press ENTER to display the Edit screen. 2. Select a character or symbol with the cursors and press ENTER. Repeat it to input 31 or less characters. "A/a": Switches between upper and lower cases. (Pressing MODE on the remote controller also toggles between upper and lower cases.) "←" "→": Moves the cursor to the arrow direction. "⊞": Removes a character on the left of the cursor. "␣": Enters a space. <ul style="list-style-type: none"> • To select whether to mask the password with "*" or display it in plain text, press +Fav on the remote controller. • Pressing CLEAR on the remote controller will remove all the input characters. 3. After inputting, select "OK" with the cursors and press ENTER. The input password will be saved.
Usage Data	No	<p>As a means of improving the quality of our products and services, Pioneer may collect information about your usage over the network. Select "Yes" if you agree to our collecting this information. Select "No" if you do not want us to collect this information.</p> <ul style="list-style-type: none"> • You can set this after confirming the Privacy Policy. When you select "Usage Data" and press ENTER, the Privacy Policy is displayed. (The same screen is displayed once also when setting up the network connection.) If you agree to the collection of the information, this setting also becomes "Yes". Note that if you agree to the Privacy Policy but select "No" for this setting, the information will not be collected.
Network Check	-	<p>You can check the network connection. Press ENTER when "Start" is displayed.</p>

- Wait for a while if "Network" cannot be selected. It will appear when the network feature is started.

Bluetooth

Setting Item	Default Value	Setting Details
Bluetooth	On	Select whether or not to use the BLUETOOTH function. "On": Enables connection with a BLUETOOTH enabled device by using the BLUETOOTH function. Select "On" also when making various BLUETOOTH settings. "Off": When not using the BLUETOOTH function
Auto Input Change	On	The input of the unit will automatically be switched to "BT AUDIO" when connection is made from a BLUETOOTH enabled device to the unit. "On": The input will automatically become "BT AUDIO" when a BLUETOOTH enabled device is connected. "Off": The function is disabled. <ul style="list-style-type: none"> • If the input is not switched automatically, set to "Off" and change the input manually.
Auto Reconnect	On	This function automatically reconnects to the BLUETOOTH enabled device connected last when you change the input to "BT AUDIO". "On": Use this function "Off": Do not use this function <ul style="list-style-type: none"> • This may not work with some BLUETOOTH enabled devices.

Setting Item	Default Value	Setting Details
Pairing Information	-	You can initialize the pairing information saved on this unit. Pressing ENTER when "Clear" is displayed initializes the pairing information stored in this unit. <ul style="list-style-type: none"> • This function does not initialize the pairing information on the BLUETOOTH enabled device. When pairing the unit again with the device, be sure to clear the pairing information on the BLUETOOTH enabled device in advance. For information on how to clear the pairing information, refer to the BLUETOOTH enabled device's instruction manual.
Device	-	Displays the name of the BLUETOOTH enabled device connected to the unit. <ul style="list-style-type: none"> • The name is not displayed when "Status" is "Ready" and "Pairing".
Status	-	Displays the status of the BLUETOOTH enabled device connected to the unit. "Ready": Not paired "Pairing": Paired "Connected": Successfully connected

- Wait for a while if "Bluetooth" cannot be selected. It will appear when the BLUETOOTH function is started up.

AV Adjust

You can quickly adjust settings you frequently use, such as tone adjustments, etc.

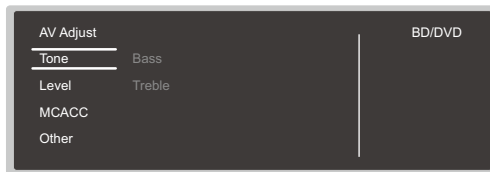

Operation:

You can make the settings on the TV screen while playing something. Press  on the remote controller to display the AV Adjust menu. Note that there is no display on the TV screen when the input selector is "CD", "TV", "PHONO", "FM", or "AM", so follow the main unit's display while doing the operations.



Select the item with the cursor  buttons of the remote controller and press ENTER to confirm your selection.

Use the cursors to change the settings.

- To return to the previous screen, press .
- To exit the settings, press .

■ Tone

Bass :

Enhance or moderate the bass range of the speaker.

Treble :

Enhance or moderate the treble range of the speaker.

- It cannot be set if the listening mode is Direct or Pure Direct.

■ Level

Center :

Adjust the speaker level of the center speaker while listening to some sound.

Subwoofer :

Adjust the speaker level of the subwoofer while listening to some sound.

- The adjustment you made will be reset to the previous status when you turn the unit to standby mode.

■ MCACC

MCACC EQ :

Enable or disable the equalizer function that corrects for distortion caused by the acoustic environment of the room.

- It cannot be set if the listening mode is Pure Direct.

Manual EQ Select :

From the Home screen, select "Preset 1" to "Preset 3" which were set in "MCACC" - "Manual MCACC" - "EQ Adjust". The same sound field setting is applied all ranges when set to "Off".

- It cannot be set if the listening mode is Pure Direct.

Phase Control:

Correct phase disturbance in the low range to enhance the bass. This enables you to achieve powerful bass reproduction that is faithful to the original sound.

- It cannot be set if the listening mode is Pure Direct.

Theater Filter :

Adjust the soundtrack that was processed to enhance

its high pitch range, in order to make it suitable for home theater. This function can be used in the following listening modes: Dolby Digital, Dolby Digital Plus, Dolby PLII Movie, Dolby TrueHD, Multichannel, DTS, DTS 96/24, DTS-HD High Resolution Audio, DTS-HD Master Audio, DTS Express, Neo:6 Cinema, and DSD.

- It cannot be set if the listening mode is Direct or Pure Direct.

■ Other

Sound Delay :

If the video is behind the audio, you can delay the audio to offset the gap. Different settings can be set for each input selector.

- It cannot be set if the listening mode is Pure Direct and the input signal is analog.

Sound Retriever:

Improve the quality of the compressed audio. Playback sound of lossy compressed files such as MP3 will be improved. The setting can be separately set to each input selector. The setting is effective in the signals of 48 kHz or less. The setting is not effective in the bitstream signals.

- It cannot be set if the listening mode is Direct or Pure Direct.

DRC :

Make small sounds easily heard. It is useful when you need to reduce the volume while watching a movie late night. You can enjoy the effect only when playing Dolby series and DTS series input signals.

- It cannot be set if the listening mode is Direct or Pure Direct.
- The setting cannot be used in the following cases.
 - If "Loudness Management" is set to "Off" when playing Dolby Digital Plus or Dolby TrueHD

Panorama :

Broaden the sound field laterally when playing in the Dolby Pro LogicII Music listening mode.

Dimension :

Adjust the depth of the sound field in the front to back

direction when playing in the Dolby Pro LogicII Music listening mode. Set a small number to move the sound towards the front. Set a large number to move the sound back.

Center Width :

Adjust the width of the front sound field when playing in the Dolby Pro LogicII Music listening mode. Set a small number to concentrate sound in the middle. Set a large number to distribute the central sound out to the left and right.

Center Image :

Adjust the width of the front sound field when playing in the DTS Neo:6 Music listening mode. Set a small number to concentrate sound in the middle. Set a large number to distribute the central sound out to the left and right.

Firmware Update

About Firmware Update

There are two methods for updating the firmware: via network and via USB.

Use the one that best suits your environment.

- For the latest information on updates, visit the our company's website. There is no need to update the firmware on this unit if there is no update available.
- Before updating, make sure that the speaker setup microphone is not connected.
- During an update, do not
 - Disconnect and reconnect any cable, USB storage device, speaker setup microphone or headphones, or perform any operation on the component such as turn off its power
 - Accessing this unit from a PC or smartphone using an application
- The update may take about 20 minutes to complete for either method: via network or via USB. Furthermore, existing settings are guaranteed regardless of the method used for update.

Note that when this unit is connected to a network, you may see notifications about firmware updates on the display. To execute updating, select "Update Now" with the cursor buttons of the remote controller and press ENTER. The unit automatically turns itself into standby mode after "Completed!" appears on the display, and updating will be complete.

Disclaimer: The program and accompanying online documentation are furnished to you for use at your own risk.

Our company will not be liable and you will have no remedy for damages for any claim of any kind whatsoever concerning your use of the program or the accompanying

online documentation, regardless of legal theory, and whether arising in tort or contract. In no event will our company be liable to you or any third party for any special, indirect, incidental, or consequential damages of any kind, including, but not limited to, compensation, reimbursement or damages on account of the loss of present or prospective profits, loss of data, or for any other reason whatsoever.

Updating the Firmware via Network

Preparation:

- Check that the unit is turned on, and the connection to the Internet is secured.
 - Turn off the controller component (PC etc.) connected to the network.
 - Stop any playing Internet radio, USB storage device, or server content.
 - If "HDMI CEC" is set to "On", set it to "Off".
 - Press  on the remote controller to display the Home screen. Next, select "System Setup" - "Hardware" - "HDMI", press ENTER, select "HDMI CEC" and select "Off".
- * The description may differ from the on-screen display but that will not change the way to operate or the function.

■ Update

1. Press  on the remote controller. The Home screen is displayed on the TV screen.

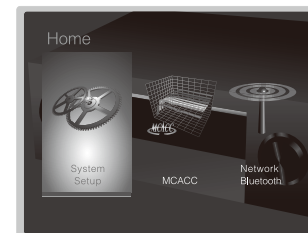

2. Select "System Setup" - "Miscellaneous" - "Firmware Update" - "Update via NET" with the cursors in order, then press ENTER.

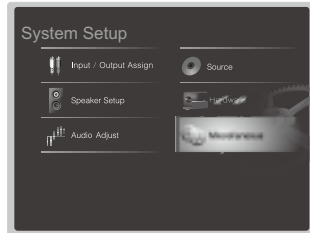

- If "Firmware Update" is grayed out and cannot be selected, wait for a while until it starts up.
 - You will not be able to select "Update via NET" if there is nothing to update.
3. Press ENTER with "Update" selected to start update.
 - During the update, the TV screen may go black depending on the updated program. In that case, check the progress on the display of the unit. The TV screen will remain black until the update is complete and the power is turned on again.
 - "Completed!" is displayed when the update is complete.
 4. Press \odot STANDBY/ON on the main unit to switch the unit to standby. The process is completed and your firmware is updated to the latest version.
 - Do not use \odot on the remote controller.

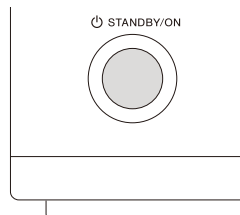

■ If an Error Message is Displayed

When an error occurs, "*-* * Error!" is displayed on the display of the unit. ("*" represents an alphanumeric character.) Check the following:

Error Code

- *-01, *-10: Ethernet cable not found. Connect the Ethernet cable properly.
- *-02, *-03, *-04, *-05, *-06, *-11, *-13, *-14, *-16, *-17, *-18, *-20, *-21: Internet connection error. Check the following:
 - The router is turned on
 - This unit and the router are connected via the network
 Try to disconnect and then connect again the power to the unit and router. This may solve the problem. If you are still unable to connect to the Internet, the DNS server or proxy server may be temporarily down. Check the service status with your ISP provider.
- **Others**
Disconnect then reconnect the AC power cord, then repeat from the beginning.

Updating via USB

Preparation:

- Prepare a 128MB or larger USB storage device. FAT16 or FAT32 file system format.
 - Media inserted in a USB card reader may not be used for this function.
 - USB storage devices with security function are not supported.
 - USB hubs and USB devices with hub function are not supported. Do not connect these devices to the unit.
- Delete any data stored on the USB storage device.
- Turn off the controller component (PC etc.) connected to the network.
- Stop any playing Internet radio, USB storage device, or server content.
- If "HDMI CEC" is set to "On", set it to "Off".
 - Press \uparrow on the remote controller to display the Home screen. Next, select "System Setup" - "Hardware" - "HDMI", press ENTER, select "HDMI CEC" and select "Off".
- * Some USB storage devices may take long to load, may not be loaded correctly, or may not be correctly fed depending on the device or their content.
- * Our company will not be liable whatsoever for any loss or damage of data, or storage failure arising from the use of the USB storage device with this unit. Thank you for your understanding.
- * The description may differ from the on-screen display but that will not change the way to operate or the function.

■ Update

1. Connect the USB storage device to your PC.
2. Download the firmware file from our company's website to your PC and unzip.
Firmware files are named in the following way:
PIOAVR****_*****.zip
Unzip the file on your PC. The number of unzipped files and folders varies depending on the model.
3. Copy all unzipped files and folders to the root folder of the USB storage device.
 - Make sure to copy the unzipped files.

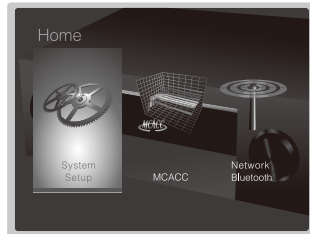

4. Connect the USB storage device to the USB port of the unit.
 - If you connect a USB hard disk drive to the USB port of the unit, we recommend that you use its AC adapter to power it.
 - If the USB storage device has been partitioned, each section will be treated as an independent device.
5. Press  on the remote controller. The Home screen is displayed on the TV screen.

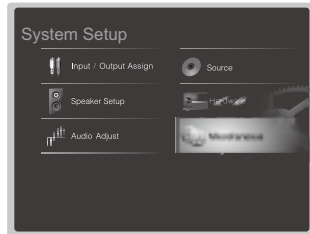

6. Select "System Setup" - "Miscellaneous" - "Firmware Update" - "Update via USB" with the cursors in order, then press ENTER.



- If "Firmware Update" is grayed out and cannot be selected, wait for a while until it starts up.
 - You will not be able to select "Update via USB" if there is nothing to update.
7. Press ENTER with "Update" selected to start update.
 - During the update, the TV screen may go black depending on the updated program. In that case, check the progress on the display of the unit. The TV screen will remain black until the update is

- complete and the power is turned on again.
 - During the update, do not turn off, or disconnect then reconnect the USB storage device.
 - "Completed!" is displayed when the update is complete.
8. Disconnect the USB storage device from the unit.
 9. Press  STANDBY/ON on the main unit to switch the unit to standby. The process is completed and your firmware is updated to the latest version.
 - Do not use  on the remote controller.

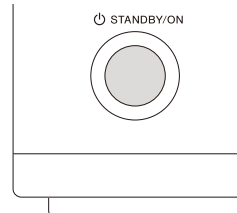

■ If an Error Message is Displayed

When an error occurs, "*-* * Error!" is displayed on the display of the unit. ("*" represents an alphanumeric character.) Check the following:

Error Code

- *-01, *-10 :
USB storage device not found. Check whether the USB storage device or USB cable is correctly inserted to the USB port of the unit.
Connect the USB storage device to an external power source if it has its own power supply.
- *-05, *-13, *-20, *-21 :
The firmware file is not present in the root folder of the USB storage device, or the firmware file is for another model. Retry from the download of the firmware file.
- **Others**
Disconnect then reconnect the AC power cord, then repeat from the beginning.

Selecting Listening Modes

You can change the listening mode during play by pressing repeatedly "AUTO/DIRECT", "SURR", or "STEREO".

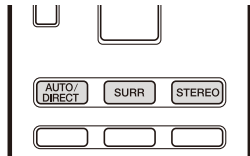

■ AUTO/DIRECT button

Press repeatedly and the listening modes suited to the input signal are switched between "Auto Surround", "Direct", and "Pure Direct". After selecting one of them, "Auto Surround" (or "Direct" or "Pure Direct") is displayed, then the most suitable listening mode for the audio format is selected automatically (Dolby Digital for multi-channel input signals, Stereo for 2 channel input signals, etc.) and an indicator such as "Dolby D" is displayed on the display.

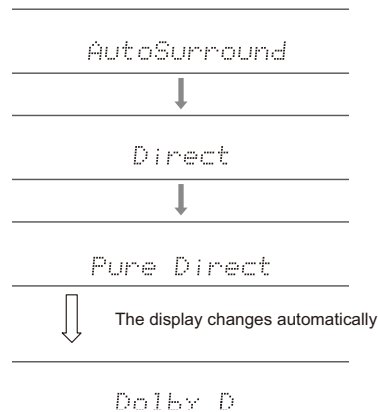

The "Direct" mode shuts down some processing that can affect sound quality, such as the tone control features, so you can enjoy even better sound quality. The "Pure Direct" mode shuts down even more processes that affects sound quality, so you get a more faithful reproduction of the original sound. In this case, the speaker calibration made with MCACC is invalid.

■ SURR button

By pressing repeatedly you can select the audio format of the signals being input and switch between a variety of listening modes. Select the mode that suits your preference. The selected listening mode is displayed on the display.

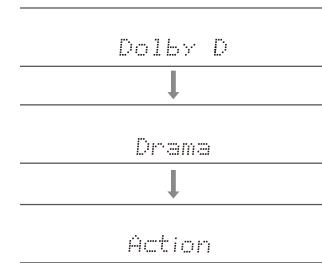

■ STEREO button

You can select the "Stereo" mode to playback only from the front speakers and subwoofer.

For details on the effects of each of the listening modes see "Listening Mode Effects". For listening modes selectable for each of the audio formats in the input signals, refer to "Selectable Listening Modes".

Listening Mode Effects

In alphabetical order

■ Action

Mode suitable for movies with a lot of action scenes.

■ AdvancedGame

Mode suitable for game content.

■ Classical

Suitable for classical or operatic music. This mode emphasizes the surround channels in order to widen the stereo image, and simulates the natural reverberation of a large hall.

■ Dolby D (Dolby Digital)

This mode faithfully reproduces the sound design recorded in the Dolby Digital audio format.

Dolby Digital is a multi-channel digital format developed by Dolby Laboratories, Inc. widely adopted for use in movie production. It is also a standard audio format on DVD-Video and Blu-ray Discs. It is possible to record a maximum of 5.1 channels on a DVD-Video or Blu-ray Disc; two front channels, a center channel, two surround channels, and the LFE channel dedicated to the bass region (sound elements for the subwoofer).

- To enable transfer of this audio format, connect via digital cable and set audio output on the player to bitstream output.

■ Dolby D+ (Dolby Digital Plus)

This mode faithfully reproduces the sound design recorded in the Dolby Digital Plus audio format.

The Dolby Digital Plus format is a revision based on Dolby Digital, increasing the number of channels and endeavoring to improve sound quality by giving more flexibility in data bit rates. Dolby Digital Plus is used as an

optional audio format on Blu-ray Discs, based on 5.1ch, but with additional channels such as the Surround Back channel added for a maximum of 7.1ch.

- To enable transfer of this audio format, connect via HDMI cable and set audio output on the player to bitstream output.

■ Dolby PLII (Dolby Pro Logic II)

These listening modes allow you to expand the playback signal to 5.1 channels to suit the connected speaker configuration when the input signal is 2 channel.

Broadening the sound field provides you with a seamless sound with more depth and realism. Along with CD and movie sources, games can also benefit from the vivid sound localization. Choose from a mode ideal for movies (Movie), a mode ideal for music (Music), and a mode ideal for gaming (Game).

■ Dolby TrueHD

This mode faithfully reproduces the sound design recorded in the Dolby TrueHD audio format.

The Dolby TrueHD audio format is a reversible format expanded based on the lossless compression technology referred to as MLP, and it makes it possible to faithfully reproduce the master audio recorded in the studio. Dolby TrueHD is used as an optional audio format on Blu-ray Discs, based on 5.1ch, but with additional channels such as the Surround Back channel added for a maximum of 7.1ch. 7.1ch is recorded at 96kHz/24bit, and 5.1ch is recorded at 192kHz/24bit.

- To enable transfer of this audio format, connect via HDMI cable and set audio output on the player to bitstream output.

■ Drama

Suitable for TV shows produced in a TV studio. This mode enhances the surround effects to the entire sound to give clarity to voices and create a realistic acoustic image.

■ DSD

Mode suitable for playing sources recorded in DSD.

- This unit supports DSD signals input through HDMI IN. However, depending on the connected player, better sound is possible when output from the PCM output of the player.
- This listening mode cannot be selected if the output setting on your Blu-ray Disc/DVD player is not set to DSD.

■ DTS

This mode faithfully reproduces the sound design recorded in the DTS audio format.

The DTS audio format is a multi-channel digital format developed by DTS, Inc. This format is an optional audio format on DVD-Video and a standard on Blu-ray Discs. It enables recording of 5.1 channels; two front channels, a center channel, two surround channels, and the LFE channel dedicated to the bass region (sound elements for the subwoofer). The content is recorded with a rich volume of data, with maximum sampling rate of 48kHz at a resolution of 24 bits and a bit rate of 1.5 Mbps.

- To enable transfer of this audio format, connect via digital cable and set audio output on the player to bitstream output.

■ DTS 96/24

This mode faithfully reproduces the sound design recorded in the DTS 96/24 audio format.

The DTS 96/24 format is an optional audio format on DVD-Video and Blu-ray Discs. It enables recording of 5.1 channels; two front channels, a center channel, two surround channels, and the LFE channel dedicated to the bass region (sound elements for the subwoofer). Detailed reproduction is achieved by recording the content at a sampling rate of 96kHz at a resolution of 24 bits.

- To enable transfer of this audio format, connect via digital cable and set audio output on the player to bitstream output.

■ DTS Express

This mode faithfully reproduces the sound design recorded in the DTS Express audio format.

DTS Express is used as an optional audio format on Blu-

ray Discs, based on 5.1ch, but with channels such as the surround back channel added for a maximum of 7.1ch. It also supports low bit rates.

- To enable transfer of this audio format, connect via HDMI cable and set audio output on the player to bitstream output.

■ DTS-HD HR (DTS-HD High Resolution Audio)

This mode faithfully reproduces the sound design recorded in the DTS-HD High Resolution Audio audio format. DTS-HD High Resolution Audio is used as an optional audio format on Blu-ray Discs, based on 5.1ch, but with additional channels such as the Surround Back channel added for a maximum of 7.1ch. It can be recorded at a sampling rate of 96kHz with a resolution of 24 bits.

- To enable transfer of this audio format, connect via HDMI cable and set audio output on the player to bitstream output.

■ DTS-HD MSTR (DTS-HD Master Audio)

This mode faithfully reproduces the sound design recorded in the DTS-HD Master Audio audio format. DTS-HD Master Audio is used as an optional audio format on Blu-ray Discs, based on 5.1ch, but with additional channels such as the Surround Back channel added for a maximum of 7.1ch, recorded using lossless audio reproduction technology. 96kHz/24bit is supported with 7.1ch, and 192kHz/24bit is supported with 5.1ch.

- To enable transfer of this audio format, connect via HDMI cable and set audio output on the player to bitstream output.

■ DTS Neo:6

These listening modes allow you to expand the playback signal to 5.1 channels to suit the connected speaker configuration when the input signal is 2 channel. It offers full-bandwidth on all channels, with great independence between the channels. There are two variants for this mode: Neo:6 Cinema which is ideal for movies and Neo:6 Music which is ideal for music.

■ Ent.Show (Entertainment Show)

Suitable for rock or pop music. Listening to music in this mode creates a lively sound field with a powerful acoustic image, like being at a club or rock concert.

■ Ext.Mono (Extended Mono)

In this mode, all speakers output the same sound in mono, so the sound you hear is the same regardless of where you are within the listening room.

■ Ext.Stereo (Extended Stereo)

Ideal for background music, this mode fills the entire listening area with stereo sound from the front, surround, and surround back speakers.

■ F.S.Surround (Front Stage Surround)

In this mode, you can enjoy a virtual playback of multichannel surround sound even with only two or three speakers. This works by controlling how sounds reach the listener's left and right ears.

■ Mono

Use this mode when watching an old movie with a mono soundtrack, or use it to separately reproduce soundtracks in two different languages recorded in the left and right channels of some movies. It is also suitable for DVDs or other sources containing multiplexed audio.

■ Multich PCM (Multichannel PCM)

Mode suitable for playing sources recorded in multichannel PCM.

■ Rock/Pop

Mode suitable for rock content.

■ Sports

Mode suitable for sport content.

■ Stereo

In this mode, sound is output from the front left and right speakers and subwoofer.

■ Unplugged

Suitable for acoustic instruments, vocals and jazz. This mode emphasizes the front stereo image, giving the impression of being right in front of the stage.

Selectable Listening Modes

You can select a variety of listening modes to suit the audio format of the signal being input.

- The Stereo mode can be selected with any audio format.
- When analog signals are being input in the Pure Direct mode, the modes switches to the Analog Direct mode which passes signals directly to the amplifier without passing through the DSP (Digital Signal Processor).
- Listening modes available when headphones are connected are Pure Direct and Stereo only.

■ Selectable listening modes

Input Format	Listening Mode
Analog	Stereo
	Mono
	PL II Movie ^{*1}
	PL II Music ^{*1}
	PL II Game ^{*1}
	Neo:6 Cinema ^{*1}
	Neo:6 Music ^{*1}
	Classical ^{*2}
	Unplugged ^{*2}
	Ent.Show ^{*2}
	Drama ^{*2}
	AdvancedGame ^{*2}
	Action ^{*2}
	Rock/Pop ^{*2}
	Sports ^{*2}
	Ext.Stereo ^{*1}
	Ext.Mono ^{*1}
F.S.Surround	

^{*1} A center speaker or surround speakers need to be installed.

^{*2} Surround speakers need to be installed.

Input Format	Listening Mode
PCM Music files (except DSD/ Dolby TrueHD)	Stereo
	Mono
	PL II Movie ^{*1}
	PL II Music ^{*1}
	PL II Game ^{*1}
	Neo:6 Cinema ^{*1}
	Neo:6 Music ^{*1}
	Classical ^{*2}
	Unplugged ^{*2}
	Ent.Show ^{*2}
	Drama ^{*2}
	AdvancedGame ^{*2}
	Action ^{*2}
	Rock/Pop ^{*2}
	Sports ^{*2}
	Ext.Stereo ^{*1}
	Ext.Mono ^{*1}
F.S.Surround	

^{*1} A center speaker or surround speakers need to be installed.

^{*2} Surround speakers need to be installed.

Input Format	Listening Mode
Multich PCM	Stereo
	Multich PCM ^{*1}
	Classical ^{*2}
	Unplugged ^{*2}
	Ent.Show ^{*2}
	Drama ^{*2}
	AdvancedGame ^{*2}
	Action ^{*2}
	Rock/Pop ^{*2}
	Sports ^{*2}
	Ext.Stereo ^{*1}
	Ext.Mono ^{*1}
	F.S.Surround

*1 A center speaker or surround speakers need to be installed.

*2 Surround speakers need to be installed.

Input Format	Listening Mode
DSD	Stereo
	DSD ^{*1 *2}
	PL II Movie ^{*3}
	PL II Music ^{*3}
	PL II Game ^{*3}
	Neo:6 Cinema ^{*3}
	Neo:6 Music ^{*3}
	Classical ^{*4}
	Unplugged ^{*4}
	Ent.Show ^{*4}
	Drama ^{*4}
	AdvancedGame ^{*4}
	Action ^{*4}
	Rock/Pop ^{*4}
	Sports ^{*4}
	Ext.Stereo ^{*2}
	Ext.Mono ^{*2}
F.S.Surround	

*1 Cannot be selected when the input format is monaural or 2 ch.

*2 A center speaker or surround speakers need to be installed.

*3 Can only be selected when the input format is 2 ch and a center speaker or surround speakers are installed.

*4 Surround speakers need to be installed.

Input Format	Listening Mode
Dolby D	Stereo
	Dolby D ^{*1 *2}
	PL II Movie ^{*3}
	PL II Music ^{*3}
	PL II Game ^{*3}
	Neo:6 Cinema ^{*3}
	Neo:6 Music ^{*3}
	Classical ^{*4}
	Unplugged ^{*4}
	Ent.Show ^{*4}
	Drama ^{*4}
	AdvancedGame ^{*4}
	Action ^{*4}
Rock/Pop ^{*4}	
Sports ^{*4}	
Ext.Stereo ^{*2}	
Ext.Mono ^{*2}	
F.S.Surround	

*1 Cannot be selected when the input format is 2 ch.

*2 A center speaker or surround speakers need to be installed.

*3 Can only be selected when the input format is 2 ch and a center speaker or surround speakers are installed.

*4 Surround speakers need to be installed.

Input Format	Listening Mode
Dolby D+	Stereo
	Dolby D+ ^{*1 *2 *3}
	PL II Movie ^{*4}
	PL II Music ^{*4}
	PL II Game ^{*4}
	Neo:6 Cinema ^{*4}
	Neo:6 Music ^{*4}
	Classical ^{*5}
	Unplugged ^{*5}
	Ent.Show ^{*5}
	Drama ^{*5}
	AdvancedGame ^{*5}
	Action ^{*5}
	Rock/Pop ^{*5}
	Sports ^{*5}
	Ext.Stereo ^{*2}
Ext.Mono ^{*2}	
F.S.Surround	

*1 Cannot be selected when the input format is 2 ch.

*2 A center speaker or surround speakers need to be installed.

*3 Dolby D+ cannot be selected if the input source is Blu-ray Disc. You can select the Dolby D listening mode instead.

*4 Can only be selected when the input format is 2 ch and a center speaker or surround speakers are installed.

*5 Surround speakers need to be installed.

Input Format	Listening Mode
Dolby TrueHD	Stereo
	Dolby TrueHD ^{*1 *2}
	PL II Movie ^{*3}
	PL II Music ^{*3}
	PL II Game ^{*3}
	Neo:6 Cinema ^{*3}
	Neo:6 Music ^{*3}
	Classical ^{*4}
	Unplugged ^{*4}
	Ent.Show ^{*4}
	Drama ^{*4}
	AdvancedGame ^{*4}
	Action ^{*4}
	Rock/Pop ^{*4}
Sports ^{*4}	
Ext.Stereo ^{*2}	
Ext.Mono ^{*2}	
F.S.Surround	

*1 Cannot be selected when the input format is 2 ch.

*2 A center speaker or surround speakers need to be installed.

*3 Can only be selected when the input format is 2 ch and a center speaker or surround speakers are installed.

*4 Surround speakers need to be installed.

Input Format	Listening Mode
DTS	Stereo
	DTS ^{*1 *2}
	PL II Movie ^{*3}
	PL II Music ^{*3}
	PL II Game ^{*3}
	Neo:6 Cinema ^{*3}
	Neo:6 Music ^{*3}
	Classical ^{*4}
	Unplugged ^{*4}
	Ent.Show ^{*4}
	Drama ^{*4}
	AdvancedGame ^{*4}
	Action ^{*4}
	Rock/Pop ^{*4}
Sports ^{*4}	
Ext.Stereo ^{*2}	
Ext.Mono ^{*2}	
F.S.Surround	

*1 Cannot be selected when the input format is 2 ch.

*2 A center speaker or surround speakers need to be installed.

*3 Can only be selected when the input format is 2 ch and a center speaker or surround speakers are installed.

*4 Surround speakers need to be installed.

Input Format	Listening Mode
DTS 96/24	Stereo
	DTS 96/24 ^{*1 *2}
	PL II Movie ^{*3}
	PL II Music ^{*3}
	PL II Game ^{*3}
	Neo:6 Cinema ^{*3}
	Neo:6 Music ^{*3}
	Classical ^{*4}
	Unplugged ^{*4}
	Ent.Show ^{*4}
	Drama ^{*4}
	AdvancedGame ^{*4}
	Action ^{*4}
	Rock/Pop ^{*4}
	Sports ^{*4}
	Ext.Stereo ^{*2}
Ext.Mono ^{*2}	
F.S.Surround	

*1 Cannot be selected when the input format is 2 ch.

*2 A center speaker or surround speakers need to be installed.

*3 Can only be selected when the input format is 2 ch and a center speaker or surround speakers are installed.

*4 Surround speakers need to be installed.

Input Format	Listening Mode
DTS Express	Stereo
	DTS Express ^{*1 *2}
	PL II Movie ^{*3}
	PL II Music ^{*3}
	PL II Game ^{*3}
	Neo:6 Cinema ^{*3}
	Neo:6 Music ^{*3}
	Classical ^{*4}
	Unplugged ^{*4}
	Ent.Show ^{*4}
	Drama ^{*4}
	AdvancedGame ^{*4}
	Action ^{*4}
	Rock/Pop ^{*4}
	Sports ^{*4}
	Ext.Stereo ^{*2}
Ext.Mono ^{*2}	
F.S.Surround	

*1 Cannot be selected when the input format is 2 ch.

*2 A center speaker or surround speakers need to be installed.

*3 Can only be selected when the input format is 2 ch and a center speaker or surround speakers are installed.

*4 Surround speakers need to be installed.

Input Format	Listening Mode
DTS-HD HR	Stereo
	DTS-HD HR ^{*1 *2}
	PL II Movie ^{*3}
	PL II Music ^{*3}
	PL II Game ^{*3}
	Neo:6 Cinema ^{*3}
	Neo:6 Music ^{*3}
	Classical ^{*4}
	Unplugged ^{*4}
	Ent.Show ^{*4}
	Drama ^{*4}
	AdvancedGame ^{*4}
	Action ^{*4}
	Rock/Pop ^{*4}
	Sports ^{*4}
	Ext.Stereo ^{*2}
Ext.Mono ^{*2}	
F.S.Surround	

*1 Cannot be selected when the input format is 2 ch.

*2 A center speaker or surround speakers need to be installed.

*3 Can only be selected when the input format is 2 ch and a center speaker or surround speakers are installed.

*4 Surround speakers need to be installed.

Input Format	Listening Mode
DTS-HD MSTR	Stereo
	DTS-HD MSTR ^{*1 *2}
	PL II Movie ^{*3}
	PL II Music ^{*3}
	PL II Game ^{*3}
	Neo:6 Cinema ^{*3}
	Neo:6 Music ^{*3}
	Classical ^{*4}
	Unplugged ^{*4}
	Ent.Show ^{*4}
	Drama ^{*4}
	AdvancedGame ^{*4}
	Action ^{*4}
	Rock/Pop ^{*4}
	Sports ^{*4}
	Ext.Stereo ^{*2}
Ext.Mono ^{*2}	
F.S.Surround	

*1 Cannot be selected when the input format is 2 ch.

*2 A center speaker or surround speakers need to be installed.

*3 Can only be selected when the input format is 2 ch and a center speaker or surround speakers are installed.

*4 Surround speakers need to be installed.

AM/FM radio

Tuning into a Radio Station

■ Tuning Automatically

1. Press TUNER on the remote controller several times to select either "AM" or "FM".
2. Press MODE on the remote controller so that "TunMode:Auto" appears on the display.
3. Press the cursors $\blacktriangle/\blacktriangledown$ on the remote controller to start automatic tuning.
 - Searching automatically stops when a station is found. When tuned into a radio station, the "TUNED" indicator on the display lights. When tuned into an FM radio station, the "STEREO" indicator lights.
 - No sound is output while the "TUNED" indicator is off.

When FM broadcasts reception is poor:

Radio waves may be weak depending on the building structure and environmental conditions. In that case, perform the procedure as explained below in "Tuning Manually" to manually select the desired station.

■ Tuning Manually

1. Press TUNER on the remote controller several times to select either "AM" or "FM".
2. Press MODE on the remote controller so that "TunMode:Manual" appears on the display.
3. While pressing the cursors $\blacktriangle/\blacktriangledown$ on the remote controller, select the desired radio station.
 - The frequency changes by 1 step each time you press the button. The frequency changes continuously if the button is held down and stops when the button is released. Tune by looking at the display.

To return to the auto tuning mode:

Press MODE on the remote controller again so that "TunMode:Auto" appears on the display. The unit tunes automatically into a radio station.

Presetting a Radio Station

It allows you to register up to 40 of your favorite AM/FM radio stations. Registering radio stations in advance allows you to tune into your radio station of choice directly.

■ Registration Procedure

1. Tune into the AM/FM radio station you want to register.
2. Press +Fav on the remote controller so that the preset number on the display flashes.
3. While the preset number is flashing (about 8 seconds), repeatedly press $\blacktriangle/\blacktriangledown$ on the remote controller to select a number between 1 and 40 .
4. Press +Fav on the remote controller again to register the station.
 - When the station is registered, the preset number stops flashing.
 - Repeat this procedure for all of your favorite AM/FM radio stations.

■ Selecting a Preset Radio Station

1. Press TUNER on the remote controller.
2. Press $\blacktriangle/\blacktriangledown$ on the remote controller to select a preset number.

■ Deleting a Preset Radio Station

1. Press TUNER on the remote controller.
2. Press $\blacktriangle/\blacktriangledown$ on the remote controller to select the preset number to delete.
3. After pressing +Fav on the remote controller, press CLEAR while the preset number is flashing to delete the preset number.
 - When deleted, the number on the display goes off.

Using RDS (European, Australian and Asian models)

RDS stands for Radio Data System and is a method of transmitting data in FM radio signals. In regions using RDS, the radio station name is displayed when you tune into a radio station broadcasting program information. When you press **i** on the remote controller in this state, you can use the following functions.

■ Display text information (Radio Text)

1. While the name of the station is being displayed on the display, press **i** on the remote controller once. Radio Text (RT) broadcast by the station is displayed scrolling across the display. "No Text Data" is displayed when no text information is available.
- Unusual characters may be displayed when the unit receives unsupported characters. However, this is not a malfunction. Also, if the signal from a station is weak, information may not be displayed.

■ Search for stations by Program Type

1. While the name of the station is being displayed on the display, press **i** on the remote controller twice.
2. Press **◀▶** on the remote controller to select the Program Type you want to find, then press ENTER to start the search.

The Program Types displayed are as follows:

None
 News (News reports)
 Affairs (Current affairs)
 Info (Information)
 Sport
 Educate (Education)
 Drama
 Culture
 Science (Science and technology)
 Varied
 Pop M (Pop music)
 Rock M (Rock music)

- Easy M (Middle of the road music)
 Light M (Light classics)
 Classics (Serious classics)
 Other M (Other music)
 Weather
 Finance
 Children (Children's programmes)
 Social (Social affairs)
 Religion
 Phone In
 Travel
 Leisure
 Jazz (Jazz music)
 Country (Country music)
 Nation M (National music)
 Oldies (Oldies music)
 Folk M (Folk music)
 Document (Documentary)
- The information displayed may sometimes not match the content being broadcast by the station.
 3. When a station is found, the station flashes on the display. Press ENTER while this is happening to start receiving that station. If you don't press ENTER, the unit continues to search for another station.
 - If no stations are found, the message "Not Found" is displayed.
 - Unusual characters may be displayed when the unit receives unsupported characters. However, this is not a malfunction. Also, if the signal from a station is weak, information may not be displayed.

USB Storage Device





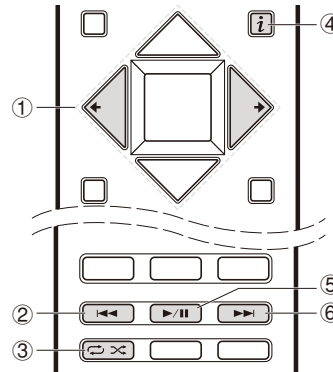

■ Playing Back

Play music files on a USB storage device.

1. Switch the input on the TV to that assigned to the unit.
 2. Plug your USB storage device with the music files into the USB port of this unit.
 3. Press "USB" on the remote controller.
 - If the "USB" indicator flashes on the display, check whether the USB storage device is plugged in properly.
 - Do not unplug the USB storage device while "Connecting..." is appeared on the display. This may cause data corruption or malfunction.
 4. Press ENTER on the remote controller again in the next screen. The list of folders and music files on the USB storage device are displayed. Select the folder with the cursors and press ENTER to confirm your selection.
 5. With the cursors on the remote controller, select the music file, and then press ENTER to start playback.
 - The USB port of this unit conforms with the USB 2.0 standard. The transfer speed may be insufficient for some content you play, which may cause some interruption in sound.
- To return to the previous screen, press .





Operations with the remote controller:



- ① : When the folder or file lists are not shown on one screen, you can change the screen.
- ② : This button plays the previous track.
- ③ : This button lets you start repeat or random playback. Pressing this button repeatedly cycles through the repeat modes.
- ④ : Pressed during play, this button changes the displayed track information. Pressed while a folder or file list is displayed, this button returns you to the play screen.
- ⑤ : Pressed during play this button pauses playback. Pressed while paused, and it restarts play.
- ⑥ : This button plays the next track.

Icons Displayed during Playback:

Icons are displayed on the display during music file playback. The meaning of each icon is as follows:

- : Folder
- : Track
- : Play
- : Pause
- : Artist
- : Album

: Repeat One Track

: Repeat within a folder

: Shuffle

■ USB Storage Device Requirements

- This unit can use USB storage devices that comply with the USB mass storage device class standard.
- FAT16 or FAT32 file system format.
- If the USB storage device has been partitioned, each section will be treated as an independent device.
- Up to 20,000 tracks per folder can be displayed, and folders may be nested up to 16 levels deep.
- USB hubs and USB storage devices with hub functions are not supported. Do not connect these devices to the unit.
- USB storage devices with security function are not supported on this unit.
- If you connect a USB hard disk drive to the USB port of the unit, we recommend that you use its AC adapter to power it.
- Media inserted to the USB card reader may not be available in this function. Depending on the USB storage device, proper reading of the contents may not be possible.
- Our company accepts no responsibility whatsoever for the loss or damage to data stored on a USB storage device when that device is used with this unit. We recommend that you back up your important music files beforehand.

■ Supported Audio Formats

For server playback and playback from a USB storage device, this unit supports the following music file formats. Note that sound files that are protected by copyright cannot be played on this unit.

MP3 (.mp3/.MP3):

- Supported formats: MPEG-1/MPEG-2 Audio Layer 3
- Supported sampling rates: 44.1 kHz, 48 kHz
- Supported bitrates: Between 8 kbps and 320 kbps. Incompatible files cannot be played.

WMA (.wma/.WMA):

- Supported sampling rates: 44.1 kHz, 48 kHz
- Supported bitrates: Between 5 kbps and 320 kbps. Incompatible files cannot be played.
- WMA Pro/Voice/WMA Lossless formats are not supported.

WAV (.wav/.WAV):

WAV files include uncompressed PCM digital audio.

- Supported sampling rates: 44.1 kHz, 48 kHz, 64 kHz, 88.2 kHz, 96 kHz, 176.4 kHz, 192 kHz
- Quantization bit: 8 bit, 16 bit, 24 bit

AIFF (.aiff/.aif/.aifc/.afc/.AIFF/.AIF/.AIFC/.AFC):

AIFF files include uncompressed PCM digital audio.

- Supported sampling rates: 44.1 kHz, 48 kHz, 64 kHz, 88.2 kHz, 96 kHz, 176.4 kHz, 192 kHz
- Quantization bit: 8 bit, 16 bit, 24 bit

AAC (.aac/.m4a/.mp4/.3gp/.3g2/.AAC/.M4A/.MP4/.3GP/.3G2):

- Supported formats: MPEG-2/MPEG-4 Audio
- Supported sampling rates: 44.1 kHz, 48 kHz, 64 kHz, 88.2 kHz, 96 kHz
- Supported bitrates: Between 8 kbps and 320 kbps. Incompatible files cannot be played.

FLAC (.flac/.FLAC):

- Supported sampling rates: 44.1 kHz, 48 kHz, 64 kHz, 88.2 kHz, 96 kHz, 176.4 kHz, 192 kHz
- Quantization bit: 8 bit, 16 bit, 24 bit

Apple Lossless (.m4a/.mp4/.M4A/.MP4):

- Supported sampling rates: 44.1 kHz, 48 kHz, 64 kHz,

88.2 kHz, 96 kHz, 176.4 kHz, 192 kHz

- Quantization bit: 16 bit, 24 bit

DSD (.dsf/.dff/.DSF/.DFF):

- Supported formats: DSF/DSDIFF
- Supported sampling rates: 2.8 MHz, 5.6 MHz

Dolby TrueHD (.vr/.mlp/.VR/.MLP):

- Supported sampling rates: 44.1 kHz, 48 kHz, 88.2 kHz, 96 kHz, 176.4 kHz, 192 kHz
- Variable bit-rate (VBR) files are supported. However, playback times may not be displayed correctly.
- This unit supports the gapless playback of the USB storage device in the following conditions. When playing WAV, FLAC and Apple Lossless, and the same format, sampling frequency, channels and quantization bit rate are played continuously

Internet Radio

TuneIn Radio

With more than 70,000 radio stations and 2 million on-demand programs registered, TuneIn Radio is a service where you can enjoy music, sports and news from all over the world.

■ Playing Back

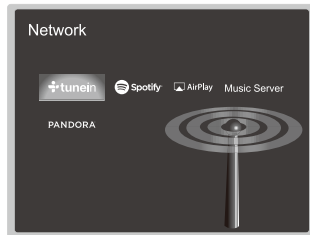

1. Switch the input on the TV to that assigned to the unit.
2. Press NET on the remote controller to display the network service list screen.

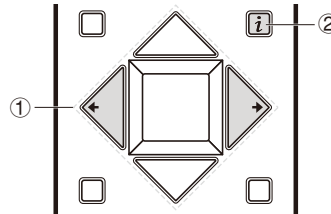

3. Select "TuneIn" with the cursors of the remote controller and press ENTER to confirm your selection.
 4. Follow the on-screen instructions, using the cursors on the remote controller to select radio stations and programs, then press ENTER to play. Play starts when 100% is displayed for buffering.
- To return to the previous screen, press .

Operations with the remote controller:



- ① : When the station or program lists are not shown on one screen, you can change the screen.
- ② : Pressed during play, this button changes the displayed track information. Pressed while a station or program list is displayed, this button returns you to the play screen.

■ Regarding the TuneIn Radio Menu

To display the TuneIn Radio menu during play, press ENTER on the remote controller. Selecting the corresponding menu item with the cursors and pressing ENTER allows you to perform the following operations:

Add to My Presets: Registers radio stations being broadcast and programs in "My Presets". Once registered, "My Presets" is displayed in the level under TuneIn Radio. To play, select the program you like from "My Presets".

Remove from My Presets: Removes a radio station or program from "My Presets".

■ Regarding the TuneIn Radio Account

Creating an account on the TuneIn Radio website (tunein.com) and logging in it from the unit allows you to automatically add your favorite radio stations and programs to your "My Presets" on the unit as you follow them on the website. "My Presets" are displayed in the level under TuneIn Radio.

To display a radio station registered in "My Presets", you must log into TuneIn Radio from the unit. To log in, select "Login" - "I have a Tunein Account" in the "TuneIn Radio"

top list on the unit, and then enter your user name and password.

- If you associate the device on My Page within the TuneIn Radio website using the registration code obtained by selecting "Login" - "Login with a registration code" on the unit, you can log in without entering the user name and password.

■ Icons on the display

 : Folder

 : Radio station

 : Playing

 : Artist

 : Album

Pandora®—Getting Started (U.S., Australia and New Zealand only)

Pandora is a free, personalized Internet radio service that plays the music you know and helps you discover music you'll love.

■ Playing Back

1. Switch the input on the TV to that assigned to the unit.
2. Press NET on the remote controller to display the network service list screen.

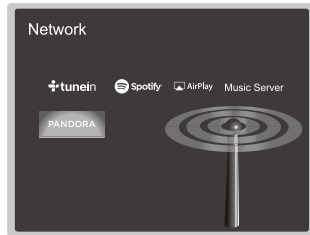

3. With the cursors on the remote controller, select "Pandora", and then press ENTER.
4. Use ▲/▼ on the remote controller to select "I have a Pandora Account" or "I'm new to Pandora" and then press ENTER.
If you are new to Pandora, select "I'm new to Pandora". You will see an activation code on your TV screen. Please write down this code. Go to an Internet connected computer and point your browser to www.pandora.com/pioneer. Enter your activation code and then follow the instructions to create your Pandora account and your personalized Pandora stations. You can create your stations by entering your favorite tracks and artists when prompted. After you have created your account and stations you can return to your receiver and press ENTER to begin listening to your personalized Pandora.
If you have an existing Pandora account, you can add your Pandora account to your receiver by selecting "I

have a Pandora Account" and logging in with your email and password.

5. To play a station, use ▲/▼ on the remote controller to select the station from your station list, and then press ENTER. Playback starts and the playback screen appears.
 - To return to the previous screen, press ⏪.

Operations with the remote controller:

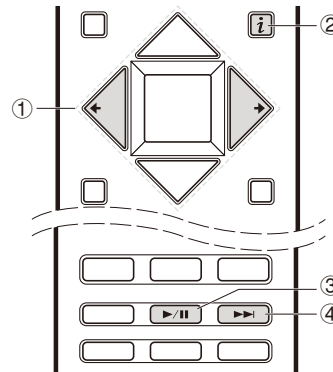

- ① ◀▶: When the station or program lists are not shown on one screen, you can change the screen.
- ② i: Pressed during play, this button changes the displayed track information. Pressed while a station or program list is displayed, this button returns you to the play screen.
- ③ ▶/||: Pressed during play this button pauses playback. Pressed while paused, and it restarts play.
- ④ ▶▶: This button plays the next track.

■ Create new station

Enter the name of a track, artist, or genre and Pandora will create a unique radio station for you based on the musical qualities of that track, artist, or genre.

■ Regarding the Pandora Menu

Icons are displayed at the bottom right of the screen while playing a station. You can do the following by selecting the icon with ▲/▼ on the remote controller and pressing ENTER:

👍 (I like this track): Give a track "thumbs-up" and Pandora will play more music like it.

👎 (I don't like this track): Give a track "thumbs-down" and Pandora will ban that track from the current station.

⋯: Automatically find stations matching your preferences based on genre, specific artists, and songs, and delete those stations you don't need.

■ Icons on the display

📁: Folder

📻: Radio station

🎵: Playing

⏸: Pause

👤: Artist

📀: Album

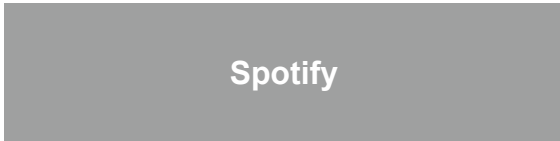

This unit supports Spotify Connect. To enable Spotify Connect, install the Spotify application on your smartphone or tablet and create a Spotify premium account.

- This unit needs to be connected to the same router as the smartphone or tablet.
- Refer to the following for Spotify settings:
www.spotify.com/connect/
- The Spotify software is subject to third party licenses found here:
www.spotify.com/connect/third-party-licenses

■ Playing Back

1. Connect the smartphone to the network that this unit is connected to.
 2. When the power of this unit is on, click the Connect icon in the track play screen of the Spotify app.
 3. Select this unit.
 4. The input selector of this unit automatically changes to NET and streaming of Spotify starts.
- When "System Setup" - "Power Management" - "Network Standby" in the Home screen is set to "On", by clicking the Connect icon and selecting this unit, then even if this unit is in standby mode, the power will come on automatically and streaming starts.

Operations with the remote controller:

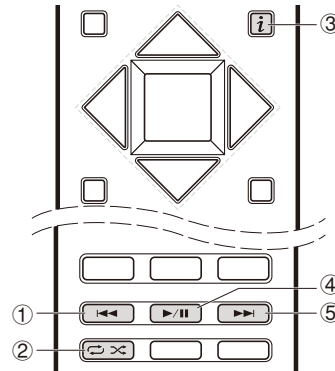

- ① ◀◀: This button plays the previous track.
- ② ↺ ↻: This button lets you start repeat or random playback. Pressing this button repeatedly cycles through the repeat modes.
- ③ ⓘ: Pressed during play, this button changes the displayed track information.
- ④ ▶/⏸: Pressed during play this button pauses playback. Pressed while paused, and it restarts play.
- ⑤ ▶▶: This button plays the next track.

■ Notes for using multi-zone (for compatible models only)

- To enjoy Spotify music in a separate room, manually select "NET" as the input of the separate room. After doing that, select this unit with the Spotify app.
- Volume adjustment with the Spotify app is possible only for speakers connected to the ZONE speaker terminals or when the volume of the audio device in the other room is configured so that its volume can be adjusted on this unit. Adjust the volume on the audio equipment in the other room in any other case.
- To enjoy Spotify music in the main room after playing it in a separate room, select "NET" as the input of the main room.



■ Icons on the display

- ▶ : Playing
- ⏸ : Pause
- 👤 : Artist
- 📀 : Album

Music Server

Overview

Streaming play of music files stored on PCs or NAS devices connected to the same network as this unit is supported.

- The network servers this unit is compatible with are those PCs with players installed that have the server functionality of Windows Media® Player 11 or 12, or NAS that are compatible with home network functionality. You may need to make some settings in advance to use Windows Media® Player 11 or 12. Note that only music files registered in the library of Windows Media® Player can be played.

Configuring the Windows Media® Player

■ Windows Media® Player 11

- Turn on your PC and start Windows Media® Player 11.
- In the "Library" menu, select "Media Sharing" to display a dialog box.
- Select the "Share my media" check box, and then click "OK" to display the compatible devices.
- Select this unit, and then click "Allow".
 - When it is clicked, the corresponding icon is checked.
- Click "OK" to close the dialog.
 - Depending of the version of Windows Media® Player, there may be differences in the names of items you can select.

■ Windows Media® Player 12

- Turn on your PC and start Windows Media® Player 12.
- In the "Stream" menu, select "Turn on media streaming" to display a dialog box.
 - If media streaming is already turned on, select "More streaming options..." in the "Stream" menu to list players in the network, and then go to step 4.
- Click "Turn on media streaming" to list players in the network.
- Select this unit in "Media streaming options" and check that it is set to "Allow".
- Click "OK" to close the dialog.
 - Depending of the version of Windows Media® Player, there may be differences in the names of items you can select.

Play

- Start the server (Windows Media® Player 11, Windows Media® Player 12, or NAS device) containing the music files to play.
- Make sure that the PCs and/or NASs are properly connected to the same network as this unit.
- Press NET on the remote controller to display the network service list screen.
 - If the "NET" indicator flashes in the display, the unit is not properly connected to the network. Check the connection.

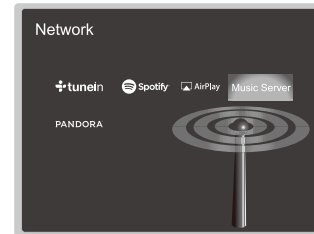

- With the cursors on the remote controller, select "Music Server", and then press ENTER.
- Select the target server with the cursors on the remote controller and press ENTER to display the items list screen.
 - The unit cannot access pictures and videos stored on servers.
 - Contents stored on the server may not be displayed depending on the server sharing settings.
- With the cursors on the remote controller, select the music file to play, and then press ENTER to start playback.
 - If "No Item." is displayed, check whether the network is properly connected.
- To return to the previous screen, press ⏪.

- For music files on a server, there can be up to 20,000 tracks per folder, and folders may be nested up to 16

levels deep.

- Depending on the media server, the unit may not recognize it, or may not be able to play its music files.

Operations with the remote controller:

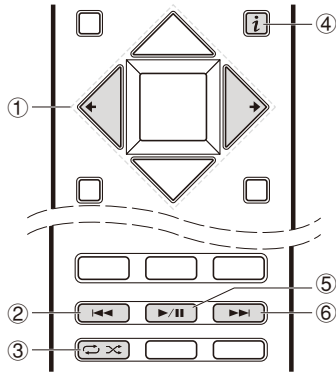

- ① ◀▶: When the folder or file lists are not shown on one screen, you can change the screen.
- ② ◀◀: This button plays the previous track.
- ③ ↺ ∞: This button lets you start repeat or random playback. Pressing this button repeatedly cycles through the repeat modes.
- ④ ⓘ: Pressed during play, this button changes the displayed track information. Pressed while a folder or file list is displayed, this button returns you to the play screen.
- ⑤ ▶▶/||: Pressed during play this button pauses playback. Pressed while paused, and it restarts play.
- ⑥ ▶▶: This button plays the next track.

Icons Displayed during Playback:

Icons are displayed on the display during music file playback. The meaning of each icon is as follows:

- : Folder
- : Track

■: Playing

||: Pause

■: Artist

■: Album

10: Repeat One Track

■ 0: Repeat within a folder

■: Shuffle

Controlling Remote Playback from a PC

You can use this unit to play music files stored on your PC by operating the PC inside your home network. The unit supports remote playback with Windows Media® Player 12. To use the remote playback function with Windows Media® Player 12, it must be configured in advance.

■ **Setting PC**

- Turn on your PC and start Windows Media® Player 12.
- In the "Stream" menu, select "Turn on media streaming" to display a dialog box.
 - If media streaming is already turned on, select "More streaming options..." in the "Stream" menu to list players in the network, and then go to step 4.
- Click "Turn on media streaming" to list players in the network.
- Select this unit in "Media streaming options" and check that it is set to "Allow".
- Click "OK" to close the dialog box.
- Open the "Stream" menu and check that "Allow remote control of my Player..." is checked.
 - Depending of the version of Windows Media® Player, there may be differences in the names of items you can select.

■ **Remote playback**

- Turn on the power of the unit.
- Turn on your PC and start Windows Media® Player 12.
- Select and right-click the music file to play with Windows Media® Player 12.
 - To remotely play a music file on another server, open the target server from "Other Libraries" and select the music file to play.
- Select this unit in "Play to" to open the "Play to" window of Windows Media® Player 12 and start playback on the unit.
 - Operations during remote playback are possible

from the "Play to" window on the PC. The playback screen is displayed on the TV connected to the HDMI output of the unit. If your PC is running on Windows® 8, click "Play to", and then select this unit.

5. Adjust the volume using the volume bar on the "Play to" window.
 - Sometimes, the volume displayed on the remote playback window may differ from that appeared on the display of the unit.
 - When the volume is adjusted from the unit, the value is not reflected in the "Play to" window.
 - This unit cannot play music files remotely in the following conditions.
 - It is using a network service.
 - It is playing a music file on a USB storage device.
 - Depending of the version of Windows Media® Player, there may be differences in the names of items you can select.

Supported Audio Formats

This unit supports the following music file formats. Note that playback via wireless LAN of sampling rates of 88.2 kHz or higher, DSD, and Dolby TrueHD are not supported. Remote play of FLAC, DSD, and Dolby TrueHD is also not supported.

MP3 (.mp3/.MP3):

- Supported formats: MPEG-1/MPEG-2 Audio Layer 3
- Supported sampling rates: 44.1 kHz, 48 kHz
- Supported bitrates: Between 8 kbps and 320 kbps. Incompatible files cannot be played.

WMA (.wma/.WMA):

- Supported sampling rates: 44.1 kHz, 48 kHz
- Supported bitrates: Between 5 kbps and 320 kbps. Incompatible files cannot be played.
- WMA Pro/Voice/WMA Lossless formats are not supported

WAV (.wav/.WAV):

WAV files include uncompressed PCM digital audio.

- Supported sampling rates: 44.1 kHz, 48 kHz, 64 kHz, 88.2 kHz, 96 kHz, 176.4 kHz, 192 kHz
- Quantization bit: 8 bit, 16 bit, 24 bit

AIFF (.aiff/.aif/.aifc/.aifc/.AIFF/.AIF/.AIFC/.AFC):

AIFF files include uncompressed PCM digital audio.

- Supported sampling rates: 44.1 kHz, 48 kHz, 64 kHz, 88.2 kHz, 96 kHz, 176.4 kHz, 192 kHz
- Quantization bit: 8 bit, 16 bit, 24 bit

AAC (.aac/.m4a/.mp4/.3gp/.3gp/.AAC/.M4A/.MP4/.3GP/.3G2):

- Supported formats: MPEG-2/MPEG-4 Audio
- Supported sampling rates: 44.1 kHz, 48 kHz, 64 kHz, 88.2 kHz, 96 kHz
- Supported bitrates: Between 8 kbps and 320 kbps. Incompatible files cannot be played.

FLAC (.flac/.FLAC):

- Supported sampling rates: 44.1 kHz, 48 kHz, 64 kHz, 88.2 kHz, 96 kHz, 176.4 kHz, 192 kHz
- Quantization bit: 8 bit, 16 bit, 24 bit

LPCM (Linear PCM) :

- Supported sampling rates: 44.1 kHz, 48 kHz
- Quantization bit: 16 bit

Apple Lossless (.m4a/.mp4/.M4A/.MP4):

- Supported sampling rates: 44.1 kHz, 48 kHz, 64 kHz, 88.2 kHz, 96 kHz
- Quantization bit: 16 bit, 24 bit

DSD (.dsf/.dff/.DSF/.DFF):

- Supported formats: DSF/DSDIFF
- Supported sampling rates: 2.8 MHz, 5.6 MHz
- Variable bit-rate (VBR) files are supported. However, playback times may not be displayed correctly.
- Remote playback does not support the gapless playback.

Troubleshooting

Before starting the procedure

Problems may be solved by simply turning the power on/off or disconnecting/connecting the power cord, which is easier than working on the connection, setting and operating procedure. Try the simple measures on both the unit and the connected device. If the problem is that the video or audio is not output or the HDMI linked operation does not work, disconnecting/connecting the HDMI cable may solve it. When reconnecting, be careful not to wind the HDMI cable since if wound the HDMI cable may not fit well. After reconnecting, turn off and on the unit and the connected device.

- This unit contains a microPC for signal processing and control functions. In very rare situations, severe interference, noise from an external source, or static electricity may cause it to lockup. In the unlikely event that this happens, unplug the power cord from the wall outlet, wait at least 5 seconds, and then plug it back in.
- Our company is not responsible for reparations for damages (such as CD rental fees) due to unsuccessful recordings caused by the unit's malfunction. Before you record important data, make sure that the material will be recorded correctly.

Power

■ Cannot turn on the unit

- Make sure that the power cord is properly plugged into the wall outlet.
- Unplug the power cord from the wall outlet, wait 5 seconds or more, then plug it in again.

■ The unit turns off unexpectedly

- The unit automatically switches to standby when the "System Setup" - "Hardware" - "Power Management" - "Auto Standby" setting in the Home screen functions.
- The protective circuit function may have been activated. If this has occurred, "AMP Diag Mode" appears on the display when the unit is turned on again, and the unit enters diagnostic mode. If the results of the diagnosis is that there is no problem, the "AMP Diag Mode" display disappears and you can use the unit normally again. If "CHECK SP WIRE" appears on the display, the speaker cables may be short-circuited. Make sure bare speaker wires are not touching each other or the back panel of the unit, then turn the unit on again. If "NG" is displayed, immediately unplug the power cord from the wall outlet and contact your dealer.
- The protective circuit function may have been activated because the temperature of the unit rose abnormally. If this happens, then the power will continue to turn off after you have turned the unit on again. Make sure the unit has plenty of space for ventilation around it, wait for the unit to cool down sufficiently, and then try turning it on again.

WARNING: If smoke, smell or abnormal noise is produced by the unit, unplug the power cord from the wall outlet immediately and contact the dealer or our company's support.

Audio

- Make sure that the speaker setup microphone is not still connected.
- Confirm that the connection between the output jack on the device and the input jack on this unit is correct.
- Make sure that none of the connecting cables are bent, twisted, or damaged.
- If the MUTE indicator on the display flashes, press  on the remote controller to cancel muting.
- While headphones are connected to the PHONES jack, no sound is output from the speakers.
- When "System Setup" - "Source" - "Audio Select" - "Fixed PCM" in the Home Menu is set to "On", no sound is played when signals other than PCM are input. Change the setting to Off.

Check the following if the above does not fix the problem:

■ There is no sound from the TV

- Change the input selector on this unit to the position of the terminal to which the TV is connected.
- If the TV doesn't support the ARC function, along with connection by HDMI, connect the TV and this unit using a digital optical cable, digital coaxial cable, or analog audio cable.

■ No sound from a connected player

- Change the input selector on this unit to the position of the terminal to which the player is connected.
- Check the digital audio output setting on the connected component. On some game consoles, such as those that support DVD, the default setting is off.
- With some DVD-Video discs, you need to select an audio output format from a menu.

■ A speaker produces no sound

- Make sure that the polarity of the speaker cables (+/−) is correct, and that no bare wires are in contact with the metal part of speaker terminals.
- Make sure that the speaker cables are not shorting.
- Check in "Connect the Speakers" in the Basic Manual that the speaker connections have been made correctly. Settings for the speaker connection environment need

to be made in "Full Auto MCACC" in Initial Setup. Check in "Initial Setup" in the Basic Manual.

- Depending on the source and current listening mode, not much sound may be produced by the surround speakers. Select another listening mode to see if sound is output.
- If you are installing surround back speakers (for compatible models only), surround speakers are required.
- A maximum of 5.1 ch playback is possible when Bi-Amping connection is used (for compatible models only). Further, make sure you remove the jumper bar on the speakers when using Bi-Amping connection.

■ **The subwoofer produces no sound**

- When you play source material that contains no information in the LFE channel, the subwoofer produces no sound.

■ **Noise can be heard**

- Using cable ties to bundle audio cables with power cords, speaker cables, etc. may degrade the audio performance, so refrain from doing it.
- An audio cable may be picking up interference. Try repositioning your cables.

■ **The beginning of audio received by an HDMI IN cannot be heard**

- Since it takes longer to identify the format of an HDMI signal than it does for other digital audio signals, audio output may not start immediately.

■ **Sound suddenly reduces**

- When the temperature inside the unit exceeds a certain temperature for extended periods, the volume may be reduced automatically to protect the circuits.

Listening Modes

- To enjoy digital surround playback, such as Dolby Digital, the audio signals need to pass through a connection via HDMI cable, digital coaxial cable, or digital optical cable. Audio output should be set to bitstream output on the connected Blu-ray Disc player

or other device.

- Press **i** on the remote controller several times to switch the display of the main unit to check the input format.

Check the following if the above does not fix the problem:

■ **Cannot select a desired listening mode**

- Depending on the connecting status of the speaker, some listening modes may not be selected. Check in "Selectable Listening Modes" in "Listening Modes" in the Advanced Manual.

■ **There is no sound with Dolby TrueHD, Dolby Atmos, and DTS-HD Master Audio (for compatible models only)**

- You need to connect surround back speakers or height speakers to enjoy Dolby Atmos. Furthermore, Dolby Atmos can only be enjoyed when the input signals are Dolby Atmos.
- If you cannot output formats such as Dolby TrueHD, Dolby Atmos, or DTS-HD Master Audio according to the format of the source, in the Blu-ray Disc player settings try setting "BD video supplementary sound" (or re-encode, secondary sound, video additional audio, etc.) to "Off". Change the listening mode for each source after changing the setting to confirm.

■ **About DTS signals**

- With media that switches suddenly from DTS to PCM, PCM playback may not start immediately. In such cases, you should stop your player for about 3 seconds and then resume playback.
- With some CD and LD players, you will not be able to playback DTS material properly even though your player is connected to a digital input on the unit. This is usually because the DTS bitstream has been processed (e.g., output level, sampling rate, or frequency response changed) and the unit does not recognize it as a genuine DTS signal. In such cases, you may hear noise.
- Playing DTS program material, using the pause, fast forward, or fast reverse function on your player may produce a short audible noise. This is not a malfunction.

Video

- Confirm that the connection between the output jack on the device and the input jack on this unit is correct.
- Make sure that none of the connecting cables are bent, twisted, or damaged.
- When the TV image is blurry or unclear, power cord or connection cables of the unit may have interfered. In that case, keep distance between TV antenna cable and cables of the unit.
- Make sure the switching of input screens is proper at the monitor side such as a TV.

Check the following if the above does not fix the problem:

■ **There is no video**

- Change the input selector on this unit to the position of the terminal to which the player is connected.

■ **There is no picture from a source connected to an HDMI IN terminal.**

- To display video from the connected player on the TV screen while the unit is in standby, you need to enable "System Setup" - "Hardware" - "HDMI" - "HDMI Standby Through" in the Home screen. Refer to "HDMI Setup" in "Setup" in the Basic Manual for information about HDMI Standby Through.
- To output video to a TV connected to the HDMI OUT SUB jack (for compatible models only), in the "AV Adjust" menu displayed when **f** is pressed on the remote controller select the HDMI OUT jack for output in "Other" - "HDMI Out".
- If you connect a player supporting HDCP2.2, be sure to connect it to one of the HDMI IN1 to IN3 jacks of the unit.
- Check if "Resolution Error" is displayed on the main unit display when video input via HDMI IN jack is not displayed. In this case, the TV does not support the resolution of the video input from the player. Change the setting on the player. Reliable operation with an HDMI-DVI adapter is not guaranteed. In addition, video signals from a PC are not supported.

■ **Images flicker**

- It is possible that the resolution of the player is not compatible with the TV's resolution. If you have connected the player to this unit with an HDMI cable, try changing the output resolution on the player. There also may be an improvement if you change the screen mode on the TV.

■ **Video and audio are out of synch**

- Video may be delayed relative to audio depending on the settings and connections with your television. To adjust, press  on the remote controller, and adjust in "Other" - "Sound Delay" in "AV Adjust".

Linked operation

■ **There is no linked operation with CEC compliant devices, such as a TV.**

- Set "System Setup" - "Hardware" - "HDMI" - "HDMI CEC" in the Home screen of the unit to "On".
- It is also necessary to set HDMI linking on the CEC compliant device. Check the instruction manual.
- When connecting a Sharp brand player or recorder to the HDMI IN 1 to 3 jacks, set "System Setup" - "Hardware" - "HDMI" - "HDMI Standby Through" to "Auto".

Tuner

■ **Radio reception is poor or there is a lot of noise.**

- Re-check the antenna connection.
- Relocate your antenna.
- Move the unit away from your TV or PC.
- Passing cars and airplanes can cause interference.
- Concrete walls weaken radio signals.
- Listen to the station in mono.
- When listening to an AM station, operating the remote controller may cause noise.
- FM reception may become clearer if you use the antenna jack on the wall used for the TV.

BLUETOOTH function

- Try plugging/unplugging the power of the unit and try turning on/off the BLUETOOTH enabled device. Restartup of the BLUETOOTH enabled device may be effective.
- The BLUETOOTH enabled devices must support the A2DP profile.
- Near components such as microwave oven or cordless phone, which use the radio wave in the 2.4 GHz range, a radio wave interference may occur, which disables the use of this unit.
- If there is a metallic object near the unit, BLUETOOTH connection may not be possible as the metal can effect on the radio waves.

Check the following if the above does not fix the problem:

■ **Cannot connect with this unit**

- Check that the BLUETOOTH function of the BLUETOOTH enabled device is enabled.

■ **Music playback is unavailable on the unit even after successful BLUETOOTH connection**

- When the audio volume of your BLUETOOTH enabled device is set low, the playback of audio may be unavailable. Volume up the BLUETOOTH enabled device.
- Depending on the BLUETOOTH enabled device, Send/Receive selector switch may be provided. Select Send mode.
- Depending on the characteristics or specifications of your BLUETOOTH enabled device, playback on the unit is not guaranteed.

■ **Sound is interrupted**

- Problem may be occurring at the BLUETOOTH enabled device. Check the information on the internet.

■ **The audio quality is poor after connection with a BLUETOOTH enabled device**

- The BLUETOOTH reception is poor. Move the BLUETOOTH enabled device closer to the unit or remove any obstacle between the BLUETOOTH enabled device and this unit.

Network function

- If you cannot select a network service, it will become selectable when the network function is started. It may take about a minute to start up.
- When NET is blinking, this unit is not properly connected to the home network.
- Try plugging/unplugging the power supply of this unit and the router, and try rebooting the router.
- If the desired wireless LAN router is not in the access point list, it may be set to hide SSID or the ANY connection may be off. Change the setting and try again.

Check the following if the above does not fix the problem:

■ Cannot access the Internet radio

- Certain network service or contents available through the unit may not be accessible in case the service provider terminates its service.
- Make sure that your modem and router are properly connected, and make sure they are both turned on.
- Make sure that the LAN side port on the router is properly connected to this unit.
- Make sure that connecting to Internet from other components is possible. If connecting is not possible, turn off all components connected to the network, wait for a while, and then turn on the components again.
- If a specific radio station is unavailable for listening, make sure the registered URL is correct, or whether the format distributed from the radio station is supported by this unit.
- Depending on ISP, setting the proxy server is necessary.
- Make sure that the used router and/or modem is supported by your ISP.

■ Cannot access the network server

- This unit needs to be connected to the same router as the network server.
- This unit is compatible with Windows Media® Player 11 or 12 network servers or NAS that are compatible with home network functionality.
- You may need to make some settings on Windows Media® Player. Check in "Music Server" in "Playback Function" in the Advanced Manual.
- When using a PC, only music files registered in the Windows Media® Player library can be played.

■ Playback stops while listening to music files on the network server

- Make sure the network server is compatible with this unit.
- When the PC is serving as the network server, try quitting any application software other than the server software (Windows Media® Player 12, etc.).
- If the PC is downloading or copying large files, the playback may be interrupted.

USB storage device

■ USB storage device is not displayed

- Check whether the USB storage device or USB cable is correctly inserted to the USB port of the unit.
- Disconnect the USB storage device from the unit, and then try reconnecting.
- Performance of the hard disk that receive power from the USB port of the unit is not guaranteed.
- Depending on the type of format, the playback may not be performed normally. Check the type of the file formats that is supported.
- USB storage devices with security functions may not be played.

Wireless LAN Network

- Try plugging/unplugging the power supply of wireless LAN router and the unit, check the wireless LAN router power-on status, and try reboot of the wireless LAN router.

Check the following if the above does not fix the problem:

■ Cannot access wireless LAN network

- The wireless LAN router setting may be switched to Manual. Return the setting to Auto.
- Try the manual set-up. The connection may succeed.
- When the wireless LAN router setting is at stealth mode (mode to hide the SSID key) or when ANY connection is off, the SSID is not displayed. Change the setting and try again.
- Check that the setting of SSID and encryption (WEP, etc.) is correct. Make sure the network settings of the unit is properly set.
- Connection to an SSID that includes multi-byte characters is not supported. Name the SSID of the wireless LAN router using single-byte alphanumeric characters only and try again.

■ Connected to an SSID different to the SSID selected

- Some wireless LAN routers allow you to set multiple SSIDs for one unit. If you use the automatic setting button on such a router, you may end up connecting with a different SSID from the SSID you wanted to connect to. Use the connection method requiring you to enter a password if this happens.

■ Playback is interrupted and communication does not work

- You may not receive radio waves due to bad radio wave conditions. Shorten the distance from the wireless LAN access point or remove obstacles to improve visibility, and try again. Place the unit away from microwave ovens or other access points. It is recommended to place the wireless LAN router (access point) and the unit in the same room.
- If there is a metallic object near the unit, wireless LAN connection may not be possible as the metal can effect

on the radio wave.

- When other wireless LAN devices are used near the unit, several issues such as interrupted playback and communication may occur. You can avoid these issues by changing the channel of your wireless LAN router. For instructions on changing channels, see the instruction manual provided with your wireless LAN router.

Multi-zone function (for compatible models only)

■ Cannot ZONE output audio of external AV component

- Depending on the model, input by HDMI cable may not be supported. Check in "Multi-zone Connection" in the Basic Manual, and if input by HDMI cable is not supported, connect using a cable that is supported.
- The audio from externally connected AV components can only be output when the audio is analog or 2ch PCM audio signals. If you have connected the AV component to this unit with a digital cable, the audio output of the AV component needs to be set to PCM.

■ Others

- Settings are required in Initial Setup, "Multi Zone Setup" to use the multi-zone feature. Check in "Initial Setup" in the Basic Manual.
- If the audio signal is from the NET input selector, zone output is not possible for DSD and Dolby TrueHD audio signals.

Remote Controller

- Make sure that the batteries are installed with the correct polarity.
- Install new batteries. Do not mix different types of batteries, or old and new batteries.
- Make sure that the unit is not subjected to direct sunshine or inverter-type fluorescent lights. Relocate if necessary.
- If the unit is installed in a rack or cabinet with colored-glass doors or if the doors are closed, the remote

controller may not work reliably.

- After operating the Multi-zone function (for compatible models only), the remote controller may have switched to the mode for operating ZONE output audio. Check "Multi-zone" in "Playback" in the Basic Manual to switch the remote controller back to the mode for operating in the main room.

Display, OSD

■ The display doesn't light

- The display may go dim while the Dimmer is working, and may also turn off (for compatible models only). Press DIMMER button and change the brightness level of the display.

Others

■ Strange noises can be heard from the unit

- If you have connected another unit to the same wall outlet as this unit, this noise may be an effect from the other unit. If the symptoms improve by unplugging the power cord of the other unit, use different wall outlets for this unit and the other unit.

■ When performing Full Auto MCACC, the message "Noise Error" appears

- This can be caused by a malfunction in your speaker unit. Check if the unit produces normal sounds.

■ DRC function does not work

- Make sure the source material is Dolby Digital, Dolby Digital Plus, Dolby TrueHD, or DTS.

Reference Information

Radio Wave Caution

This unit uses radio waves in the 2.4 GHz and 5GHz frequency bands.

There are nations and regions where the use of particular 5 GHz bands are prohibited outdoors, so do not use this unit outside in those places.

2.4 GHz radio waves are used by a variety of devices, as shown in lists 1 and 2 below.

1. Devices which use a 2.4 GHz radio wave frequency

- Cordless phones
- Cordless facsimiles
- Microwave ovens
- Wireless LAN devices (IEEE802.11b/g/n)
- Wireless AV equipment
- Wireless controllers for game systems
- Microwave oven-based health aids
- Video transmitter
- Specific type of external monitor and LCD display

2. Less common devices which use a 2.4 GHz radio wave frequency

- Anti-theft systems
- Amateur radio stations (HAM)
- Warehouse logistic management systems
- Discrimination systems for train or emergency vehicles

If these devices and the AV receiver are used at the same time, the audio may be undesirably stopped or disturbed due to a radio wave interference.

Suggestions for improvement

- Switch off the devices which emit the radio wave.
- Place the interfering devices away from the AV receiver.
- The AV receiver uses radio wave, and a third person can receive the wave on purpose or accidentally. Do not use the communication for important or fatal matters.

- We assume no responsibility whatsoever for any error or damage of network environment or access device resulting from the use of this apparatus. Confirm with the provider or access device maker for more information.

Scope of Operation

Use of the AV receiver is limited to home use.

(Transmission distances may be reduced depending on communication environment.)

In the following locations, poor condition or inability to receive radio waves may cause the audio to be interrupted or stopped:

- In reinforced concrete buildings or steel framed or iron framed buildings.
- Near large metallic furniture.
- In a crowd of people or near a building or obstacle.
- In a location exposed to the magnetic field, static electricity or radio wave interference from radio communication equipment using the same frequency band (2.4 GHz) as the AV receiver, such as a 2.4 GHz wireless LAN device (IEEE802.11b/g/n) or microwave oven.
- If you live in a heavily populated residential area (apartment, townhouse, etc.) and if your neighbor's microwave oven is placed near your AV receiver, you may experience radio wave interference. If this occurs, move your AV receiver to a different place. When the microwave oven is not in use, there will be no radio wave interference.

Radio Wave Reflections

The radio waves received by the AV receiver include the radio wave coming directly from the devices and waves coming from various directions due to reflections by walls, furniture and building (reflected waves). The reflected waves (due to obstacles and reflecting objects) further produce a variety of reflected waves as well as variation in reception condition depending on locations. If the audio cannot be received properly due to this phenomenon, try moving the location of the wireless LAN device a little. Also note that audio may be interrupted due to the reflected waves when a person crosses or approaches the space between the AV receiver and the wireless LAN device.

- We assume no responsibility whatsoever for any damages resulting from the use of this apparatus except in the cases deemed acceptable under the applicable laws and regulations.
- Operation in all environment is not guaranteed for wireless LAN. The communication may not be possible or have desirable communication speed.

Precautions

- Do not use this apparatus near an electronic device handling high-accuracy controls or weak signals. Doing so may cause an accident due to a malfunction of the device.
- Do not use this apparatus in use prohibited location such as an aircraft equipment or a hospital. Doing so may cause an accident due to a malfunction of an electronic device or an electro-medical apparatus. Follow the instructions of the medical facilities.

■ Electronic device which requires cautions

Hearing aid, pace maker, other medical electronic devices, fire alarm, automatic door, and other automatic control device.

When using a pace maker or other medical electronic devices, confirm with the medical electronic device maker or dealer for the effect of the radio wave.

Pioneer

2-3-12 Yaesu, Chuo-ku, Tokyo 104-0028 JAPAN

<U.S.A.>

18 PARK WAY, UPPER SADDLE RIVER, NEW JERSEY 07458, U.S.A.

Tel: 1-201-785-2600 Tel: 1-844-679-5350

<Germany>

Hanns-Martin-Schleyer-Straße 35, 47877 Willich, Germany

Tel: +49(0)2154 913222

<UK>

Anteros Building, Odyssey Business Park, West End Road, South Ruislip,
Middlesex, HA4 6QQ United Kingdom

Tel: +44(0)208 836 3612

<France>

6, Avenue de Marais F - 95816 Argenteuil Cedex FRANCE

Tel: +33(0)969 368 050

Корпорация О энд Пи

2-3-12, Яэсу, Чуо-ку, г. Токио, 104-0028, ЯПОНИЯ

Register your product on

<http://www.pioneerelectronics.com> (US)

<http://www.pioneerelectronics.ca> (Canada)

<http://www.pioneer.eu> (Europe)

© 2016 Onkyo & Pioneer Corporation. All rights reserved.

© 2016 Onkyo & Pioneer Corporation. Tous droits de reproduction et de traduction réservés.

Onkyo group has established its Privacy Policy, available at [<http://www.pioneer-audiovisual.com/privacy/>].

"Pioneer" is a trademark of Pioneer Corporation, and is used under license.

SN 29402300PDF_EN

F1603-0



* 2 9 4 0 2 3 0 0 *