

Pioneer

AV Receiver

VSX-1022-K

VSX-822-K

Register your product on

<http://www.pioneerelectronics.com> (US)

<http://www.pioneerelectronics.ca> (Canada)

• **Protect your new investment**

The details of your purchase will be on file for reference in the event of an insurance claim such as loss or theft.

• **Receive free tips, updates and service bulletins on your new product**

• **Improve product development**

Your input helps us continue to design products that meet your needs.

• **Receive a free Pioneer newsletter**

Registered customers can opt in to receive a monthly newsletter.

Operating Instructions

IMPORTANT



The lightning flash with arrowhead symbol, within an equilateral triangle, is intended to alert the user to the presence of uninsulated "dangerous voltage" within the product's enclosure that may be of sufficient magnitude to constitute a risk of electric shock to persons.

CAUTION

RISK OF ELECTRIC SHOCK
DO NOT OPEN

CAUTION:
TO PREVENT THE RISK OF ELECTRIC SHOCK, DO NOT REMOVE COVER (OR BACK). NO USER-SERVICEABLE PARTS INSIDE. REFER SERVICING TO QUALIFIED SERVICE PERSONNEL.



The exclamation point within an equilateral triangle is intended to alert the user to the presence of important operating and maintenance (servicing) instructions in the literature accompanying the appliance.

D3-4-2-1-1_A1_En

NOTE:

This equipment has been tested and found to comply with the limits for a Class B digital device, pursuant to Part 15 of the FCC Rules. These limits are designed to provide reasonable protection against harmful interference in a residential installation. This equipment generates, uses, and can radiate radio frequency energy and, if not installed and used in accordance with the instructions, may cause harmful interference to radio communications. However, there is no guarantee that interference will not occur in a particular installation. If this equipment does cause harmful interference to radio or television reception, which can be determined by turning the equipment off and on, the user is encouraged to try to correct the interference by one or more of the following measures:

- Reorient or relocate the receiving antenna.
- Increase the separation between the equipment and receiver.
- Connect the equipment into an outlet on a circuit different from that to which the receiver is connected.
- Consult the dealer or an experienced radio/TV technician for help.

D8-10-1-2_A1_En

Information to User

Alterations or modifications carried out without appropriate authorization may invalidate the user's right to operate the equipment.

D8-10-2_A1_En

WARNING

This equipment is not waterproof. To prevent a fire or shock hazard, do not place any container filled with liquid near this equipment (such as a vase or flower pot) or expose it to dripping, splashing, rain or moisture.

D3-4-2-1-3_A1_En

WARNING

To prevent a fire hazard, do not place any naked flame sources (such as a lighted candle) on the equipment.

D3-4-2-1-7a_A1_En

WARNING

Before plugging in for the first time, read the following section carefully.

The voltage of the available power supply differs according to country or region. Be sure that the power supply voltage of the area where this unit will be used meets the required voltage (e.g., 230 V or 120 V) written on the rear panel.

D3-4-2-1-4*_A1_En

VENTILATION CAUTION

When installing this unit, make sure to leave space around the unit for ventilation to improve heat radiation (at least 40 cm at top, 20 cm at rear, and 20 cm at each side).

WARNING

Slots and openings in the cabinet are provided for ventilation to ensure reliable operation of the product, and to protect it from overheating. To prevent fire hazard, the openings should never be blocked or covered with items (such as newspapers, table-cloths, curtains) or by operating the equipment on thick carpet or a bed.

D3-4-2-1-7b*_A1_En

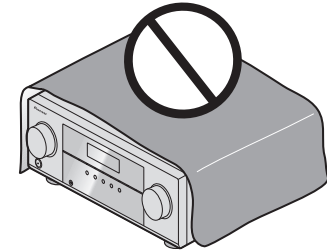

Operating Environment

Operating environment temperature and humidity:
+5 °C to +35 °C (+41 °F to +95 °F); less than 85 %RH (cooling vents not blocked)

Do not install this unit in a poorly ventilated area, or in locations exposed to high humidity or direct sunlight (or strong artificial light)

D3-4-2-1-7c*_A1_En

Caution

To prevent fire hazard, the Class 2 Wiring Cable should be used for connection with speaker, and should be routed away from hazards to avoid damage to the insulation of the cable.

D3-7-13-67*_A1_En

IMPORTANT SAFETY INSTRUCTIONS

- 1) Read these instructions.
- 2) Keep these instructions.
- 3) Heed all warnings.
- 4) Follow all instructions.
- 5) Do not use this apparatus near water.
- 6) Clean only with dry cloth.
- 7) Do not block any ventilation openings. Install in accordance with the manufacturer's instructions.
- 8) Do not install near any heat sources such as radiators, heat registers, stoves, or other apparatus (including amplifiers) that produce heat.
- 9) Do not defeat the safety purpose of the polarized or grounding-type plug. A polarized plug has two blades with one wider than the other. A grounding type plug has two blades and a third grounding prong. The wide blade or the third prong are provided for your safety. If the provided plug does not fit into your outlet, consult an electrician for replacement of the obsolete outlet.
- 10) Protect the power cord from being walked on or pinched particularly at plugs, convenience receptacles, and the point where they exit from the apparatus.

- 11) Only use attachments/accessories specified by the manufacturer.
- 12) Use only with the cart, stand, tripod, bracket, or table specified by the manufacturer, or sold with the apparatus. When a cart is used, use caution when moving the cart/apparatus combination to avoid injury from tip-over.



- 13) Unplug this apparatus during lightning storms or when unused for long periods of time.
- 14) Refer all servicing to qualified service personnel. Servicing is required when the apparatus has been damaged in any way, such as power-supply cord or plug is damaged, liquid has been spilled or objects have fallen into the apparatus, the apparatus has been exposed to rain or moisture, does not operate normally, or has been dropped.

D3-7-13-69_En

This Class B digital apparatus complies with Canadian ICES-003.

D8-10-1-3_A1_En

CAUTION

This product satisfies FCC regulations when shielded cables and connectors are used to connect the unit to other equipment. To prevent electromagnetic interference with electric appliances such as radios and televisions, use shielded cables and connectors for connections.

D8-10-3a_A1_En

IMPORTANT NOTICE

THE MODEL NUMBER AND SERIAL NUMBER OF THIS EQUIPMENT ARE ON THE REAR OR BOTTOM. RECORD THESE NUMBERS ON YOUR ENCLOSED WARRANTY CARD AND KEEP IN A SAFE PLACE FOR FUTURE REFERENCE.

D36-AP9-1_A1_En

WARNING: Handling the cord on this product or cords associated with accessories sold with the product may expose you to chemicals listed on proposition 65 known to the State of California and other governmental entities to cause cancer and birth defect or other reproductive harm.

Wash hands after handling.

D36-P5_B1_En

If the AC plug of this unit does not match the AC outlet you want to use, the plug must be removed and appropriate one fitted. Replacement and mounting of an AC plug on the power supply cord of this unit should be performed only by qualified service personnel. If connected to an AC outlet, the cut-off plug can cause severe electrical shock. Make sure it is properly disposed of after removal. The equipment should be disconnected by removing the mains plug from the wall socket when left unused for a long period of time (for example, when on vacation).

D3-4-2-2-1a_A1_En

CAUTION

The **STANDBY/ON** switch on this unit will not completely shut off all power from the AC outlet. Since the power cord serves as the main disconnect device for the unit, you will need to unplug it from the AC outlet to shut down all power. Therefore, make sure the unit has been installed so that the power cord can be easily unplugged from the AC outlet in case of an accident. To avoid fire hazard, the power cord should also be unplugged from the AC outlet when left unused for a long period of time (for example, when on vacation).

D3-4-2-2-2a*_A1_En

This product is for general household purposes. Any failure due to use for other than household purposes (such as long-term use for business purposes in a restaurant or use in a car or ship) and which requires repair will be charged for even during the warranty period.

K041_A1_En

(Symbol examples for batteries)

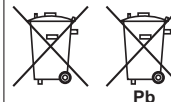

These symbols are only valid in the European Union.

K058c_A1_En

Contents

Thank you for buying this Pioneer product. Please read through these operating instructions so you will know how to operate your model properly.

| | |
|---|----------|
| Before you start | 6 |
| Checking what's in the box | 6 |
| Installing the receiver | 6 |
| Flow of settings on the receiver | 6 |
| 01 Controls and displays | |
| Front panel | 7 |
| Display | 8 |
| Remote control | 9 |
| Loading the batteries | 10 |
| Operating range of remote control | 10 |
| 02 Connecting your equipment | |
| Determining the speakers' application | 11 |
| Some tips for improving sound quality | 11 |
| Connecting the speakers | 12 |
| Connect the surround back or front height speakers (In case of VSX-1022) | 12 |
| Connect the surround back or front height speakers (In case of VSX-822) | 12 |
| Switching the speaker terminal | 14 |
| Making cable connections | 14 |
| HDMI cables | 14 |
| About HDMI | 14 |
| Analog audio cables | 15 |
| Digital audio cables | 15 |
| Video cables | 15 |
| About the video converter (VSX-1022 only) | 16 |
| About video outputs connection (VSX-822 only) | 16 |
| Connecting a TV and playback components | 17 |
| Connecting using HDMI | 17 |
| Connecting your TV with no HDMI input | 18 |
| Connecting your DVD player with no HDMI output (VSX-1022 only) | 19 |
| Connecting optional <i>Bluetooth</i> [®] ADAPTER | 20 |
| Connecting to the network through LAN interface | 20 |
| Connecting antennas | 21 |
| Using external antennas | 21 |
| Connecting an iPod | 21 |
| Connecting a USB device | 22 |
| Plugging in the receiver | 22 |

| | |
|--|----|
| 03 Basic Setup | |
| Canceling the demo display | 23 |
| Automatically setting up for surround sound (MCACC) .. | 23 |
| Other problems when using the Auto MCACC setup .. | 24 |
| 04 Basic playback | |
| Playing a source | 25 |
| Selecting the audio input signal | 25 |
| Playing an iPod | 27 |
| Playing back files stored on an iPod | 27 |
| Basic playback controls | 27 |
| Watching photos and video content | 27 |
| Playing a USB device | 28 |
| Playing back audio files stored on a USB memory device | 28 |
| Playing back photo files stored on a USB memory device | 28 |
| About playable file formats | 29 |
| <i>Bluetooth</i> [®] ADAPTER for Wireless Enjoyment of Music .. | 30 |
| Wireless music play | 30 |
| Pairing the <i>Bluetooth</i> ADAPTER and <i>Bluetooth</i> wireless technology device | 30 |
| Listening to Music Contents of <i>Bluetooth</i> wireless technology device with Your System | 31 |
| AIR JAM | 31 |
| Listening to the radio | 32 |
| Improving FM sound | 32 |
| Saving station presets | 32 |
| Listening to station presets | 32 |
| Naming preset stations | 32 |
| 05 Listening to your system | |
| Choosing the listening mode | 33 |
| Auto playback | 33 |
| Listening in surround sound | 33 |
| Using the Advanced surround | 34 |
| Using Stream Direct | 34 |
| Using the Sound Retriever | 34 |
| Listening with Acoustic Calibration EQ | 34 |
| Better sound using Phase Control | 35 |
| Using surround back channel processing | 35 |
| Setting the Up Mix function | 35 |
| Setting the Audio options | 36 |

| | |
|---|----|
| 06 Playback with NETWORK features | |
| Introduction | 38 |
| About playable DLNA network devices | 38 |
| Using AirPlay on iPod touch, iPhone, iPad, and iTunes .. | 38 |
| About the DHCP server function | 38 |
| Authorizing this receiver | 38 |
| Playback with Network functions | 39 |
| Basic playback controls | 39 |
| Listening to Internet radio stations | 39 |
| Listening to Pandora Internet Radio | 40 |
| Playing back audio files stored on components on the network | 40 |
| Playing back your favorite songs | 40 |
| The Network Setup menu | 41 |
| Network Configuration | 41 |
| Language | 42 |
| Firmware Update | 42 |
| Factory Reset | 42 |
| System Information | 42 |
| About network playback | 43 |
| Content playable over a network | 43 |
| About playback behavior over a network | 44 |
| Glossary | 44 |
| About playable file formats | 45 |
| 07 Home Menu | |
| Using the Home Menu | 46 |
| Manual speaker setup | 46 |
| Speaker Setting | 46 |
| X.Over | 47 |
| Channel Level | 48 |
| Speaker Distance | 48 |
| The Input Assign menu | 49 |
| Analog Input | 49 |
| Component Input (VSX-1022 only) | 49 |
| The Speaker System setting (VSX-1022 only) | 49 |
| The Video Parameter setting (VSX-1022 only) | 49 |
| Video Converter | 49 |
| Resolution | 50 |
| Aspect | 50 |
| The Pre Out Setting (VSX-822 only) | 50 |
| The Auto Power Down menu | 51 |
| The Network Standby menu | 51 |
| The FL Demo Mode menu | 51 |

08 Control with HDMI function

| | |
|--|----|
| Making Control with HDMI connections..... | 52 |
| HDMI Setup | 52 |
| Before using synchronization..... | 53 |
| About synchronized operations | 53 |
| Cautions on the Control with HDMI function | 53 |

09 Controlling the rest of your system

| | |
|--|----|
| Setting the remote to control other components | 54 |
| Selecting preset codes directly..... | 54 |
| Clearing all the remote control settings | 54 |
| Controls for TVs | 55 |
| Controls for other components..... | 55 |
| Preset Code List | 55 |

10 Additional information

| | |
|--|----|
| Troubleshooting | 59 |
| General | 59 |
| NETWORK feature..... | 60 |
| HDMI | 61 |
| Important information regarding the HDMI connection | 61 |
| Windows 7 | 62 |
| About iPod/iPhone/iPad | 62 |
| About FLAC | 62 |
| About messages displayed when using network functions | 63 |
| Resetting the main unit | 63 |
| Cleaning the unit | 63 |
| Specifications..... | 64 |

Before you start

Checking what's in the box

Please check that you've received the following supplied accessories:

- Setup microphone
- Remote control
- AAA size IEC R03 dry cell batteries (to confirm system operation) x2
- AM loop antenna
- FM wire antenna
- iPod cable
- Warranty card
- Quick start guide
- Safety Brochure
- These operating instructions (CD-ROM)

Installing the receiver

- When installing this unit, make sure to put it on a level and stable surface.

Don't install it on the following places:

- on a color TV (the screen may distort)
- near a cassette deck (or close to a device that gives off a magnetic field). This may interfere with the sound.
- in direct sunlight
- in damp or wet areas
- in extremely hot or cold areas
- in places where there is vibration or other movement
- in places that are very dusty
- in places that have hot fumes or oils (such as a kitchen)

Flow of settings on the receiver

The unit is a full-fledged AV receiver equipped with an abundance of functions and terminals. It can be used easily after following the procedure below to make the connections and settings.

The colors of the steps indicate the following:

Required setting item

Setting to be made as necessary

1 Connecting the speakers

Where you place the speakers will have a big effect on the sound.

- Determining the speakers' application ([page 11](#))
- Connecting the speakers ([page 12](#))
- Switching the speaker terminal ([page 14](#))



2 Connecting the components

For surround sound, you'll want to hook up using a digital connection from the Blu-ray Disc/DVD player to the receiver.

- About the video converter (VSX-1022 only) ([page 16](#))
- About video outputs connection (VSX-822 only) ([page 16](#))
- Connecting a TV and playback components ([page 17](#))
- Connecting antennas ([page 21](#))
- Plugging in the receiver ([page 22](#))



3 Power On

Make sure you've set the video input on your TV to this receiver. Check the manual that came with the TV if you don't know how to do this.



4 The Speaker System setting (VSX-1022 only) ([page 49](#))

(Specify either using the surround back or front height speaker.)

The Pre Out Setting (VSX-822 only) ([page 50](#))

(When connecting the front height speakers.)

The Input Assign menu ([page 49](#))

(When using connections other than the recommended connections.)

HDMI Setup ([page 52](#))

(When the connected TV supports the HDMI Audio Return Channel function.)



5 Use the on-screen automatic MCACC setup to set up your system

- Automatically setting up for surround sound (MCACC) ([page 23](#))



6 Basic playback ([page 25](#))

- Selecting the audio input signal ([page 25](#))
- Playing an iPod ([page 27](#))
- Playing a USB device ([page 28](#))
- Choosing the listening mode ([page 33](#))



7 Adjusting the sound as desired

- Using the Sound Retriever ([page 34](#))
- Better sound using Phase Control ([page 35](#))
- Listening with Acoustic Calibration EQ ([page 34](#))
- Using surround back channel processing ([page 35](#))
- Setting the Up Mix function ([page 35](#))
- Setting the Audio options ([page 36](#))
- Manual speaker setup ([page 46](#))



8 Making maximum use of the remote control

- Setting the remote to control other components ([page 54](#))

Front panel

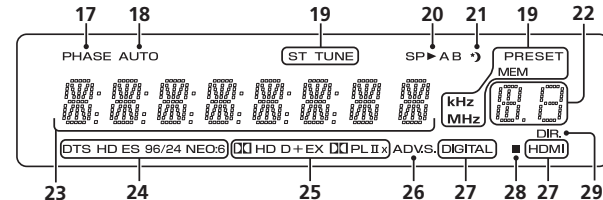
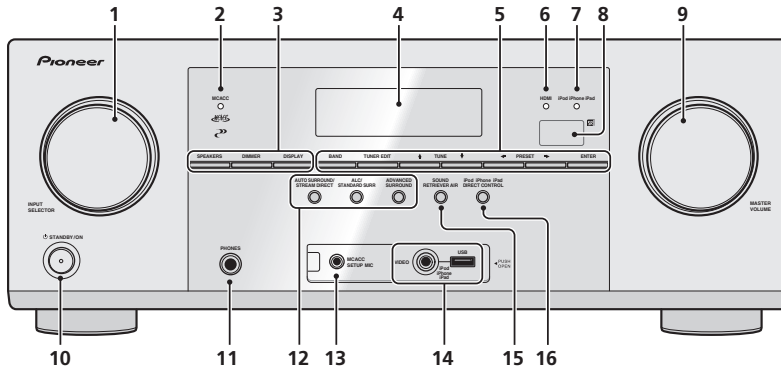
**1 INPUT SELECTOR dial**

Selects an input source ([page 25](#)).

2 MCACC indicator

Lights when Acoustic Calibration EQ ([page 34](#)) is on (Acoustic Calibration EQ is automatically set to on after the Auto MCACC setup ([page 23](#))).

3 Receiver control buttons

SPEAKERS – See [Switching the speaker terminal on page 14](#).

DIMMER – Dims or brightens the display. The brightness can be controlled in four steps.

DISPLAY – Switches the display of this unit. The listening mode, sound volume, Speaker System (*V SX-1022*)/Pre Out (*V SX-822*) setting or input name can be checked by selecting an input source.

- The Speaker System/Pre Out setting may or may not be displayed, depending on the input source you have selected.

4 Character display

See [Display on page 8](#).

5 Tuner control buttons

BAND – Switches between AM, FM ST (stereo) and FM MONO radio bands ([page 32](#)).

TUNER EDIT – Use with **TUNE** \uparrow/\downarrow . **PRESET** \leftarrow/\rightarrow and **ENTER** to memorize and name stations for recall ([page 32](#)).

TUNE \uparrow/\downarrow – Used to find radio frequencies ([page 32](#)).

PRESET \leftarrow/\rightarrow – Used to select preset radio stations ([page 32](#)).

6 HDMI indicator

Blinks when connecting an HDMI-equipped component; lights when the component is connected ([page 17](#)).

7 iPod iPhone iPad indicator

Lights when an iPod/iPhone/iPad is connected and **iPod/USB** input is selected ([page 27](#)).

8 Remote sensor

Receives the signals from the remote control (see [Operating range of remote control on page 10](#)).

9 MASTER VOLUME dial**10 \odot STANDBY/ON****11 PHONES jack**

Use to connect headphones. When the headphones are connected, there is no sound output from the speakers. The listening mode when the sound is heard from the headphone can be selected only from **PHONES SURR. STEREO** or **STEREO ALC mode (S.R AIR mode can be also selected with ADAPTER input)**.

12 Listening mode buttons

AUTO SURROUND/STREAM DIRECT – Switches between Auto surround mode ([page 33](#)) and Stream Direct playback ([page 34](#)).

ALC/STANDARD SURR – Press for standard decoding and to switch between the modes of $\square\square$ Pro Logic II, $\square\square$ Pro Logic IIx, $\square\square$ Pro Logic IIz and NEO:6, and the Auto level control stereo mode ([page 33](#)).

ADVANCED SURROUND – Switches between the various surround modes ([page 34](#)).

13 MCACC SETUP MIC jack

Use to connect a microphone when performing Auto MCACC setup ([page 23](#)).

14 iPod iPhone iPad/USB terminal

Use to connect your Apple iPod or USB mass storage device as an audio source ([page 21](#)).

15 SOUND RETRIEVER AIR

When the button is pressed, the input switches to **ADAPTER** and the listening mode is automatically set to **S.R AIR** ([page 31](#)).

16 iPod iPhone iPad DIRECT CONTROL

Change the receiver's input to the iPod and enable iPod operations on the iPod ([page 28](#)).

Display

17 PHASE

Lights when the Phase Control is switched on ([page 35](#)).

18 AUTO

Lights when the Auto Surround feature is switched on ([page 33](#)).

19 Tuner indicators

ST – Lights when a stereo FM broadcast is being received in auto stereo mode ([page 32](#)).

TUNE – Lights when a normal broadcast channel.

PRESET – Shows when a preset radio station is registered or called.

MEM – Blinks when a radio station is registered.

kHz/MHz – Lights when the character display is showing the currently received AM/FM broadcast frequency.

20 Speaker indicators

Shows if the speaker system is on or not ([page 14](#)).

21 Sleep timer indicator

Lights when the receiver is in sleep mode ([page 9](#)).

22 PRESET information or input signal indicator

Shows the preset number of the tuner or the input signal type, etc.

23 Character display

Displays various system information.

24 DTS indicators

DTS – Lights when a source with DTS encoded audio signals is detected.

HD – Lights when a source with DTS-EXPRESS or DTS-HD encoded audio signals is detected.

ES – Lights to indicate DTS-ES decoding.

96/24 – Lights when a source with DTS 96/24 encoded audio signals is detected.

NEO:6 – When one of the NEO:6 modes of the receiver is on, this lights to indicate NEO:6 processing ([page 33](#)).

25 Dolby Digital indicators

D – Lights when a Dolby Digital encoded signal is detected.

D+ – Lights when a source with Dolby Digital Plus encoded audio signals is detected.

HD – Lights when a source with Dolby TrueHD encoded audio signals is detected.

EX – Lights to indicate Dolby Digital EX decoding.

PLII(x) – Lights to indicate **D** Pro Logic II/**D** Pro Logic IIx decoding. Light will go off during **D** Pro Logic IIz decoding (see [Listening in surround sound on page 33](#) for more on this).

26 ADV.S.

Lights when one of the Advanced Surround modes has been selected (see [Using the Advanced surround on page 34](#) for more on this).

27 SIGNAL SELECT indicators

DIGITAL – Lights when a digital audio signal is selected. Blinks when a digital audio signal is selected and selected audio input is not provided.

HDMI – Lights when an HDMI signal is selected. Blinks when an HDMI signal is selected and selected HDMI input is not provided.

28 Up Mix/DIMMER indicator

Lights when the Up Mix function is set to **ON** ([page 35](#)). Also, lights when DIMMER is set to off.

29 DIR.

Lights when the **DIRECT** or **PURE DIRECT** mode is switched on ([page 34](#)).

Removing the front cover

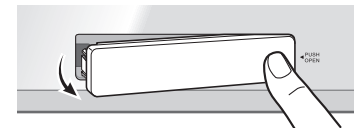

Attaching the front cover



Remote control

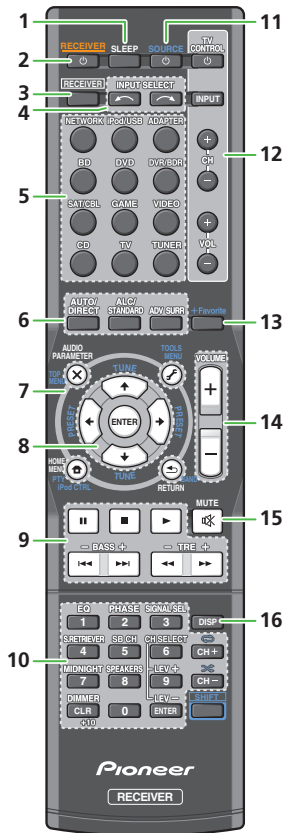

• The following buttons are not used with this receiver:

– **PTY**, **[SHIFT]**

1 SLEEP

Press to change the amount of time before the receiver switches into standby (**30 min – 60 min – 90 min – Off**). You can check the remaining sleep time at any time by pressing **SLEEP** once.

2 **RECEIVER**

Switches the receiver between standby and on.

3 **RECEIVER**

Switches the remote to control the receiver (used to select the white commands above the number buttons (**MIDNIGHT**, etc)). Also use this button to set up surround sound ([page 46](#)) or Audio parameters ([page 36](#)).

4 **INPUT SELECT**

Use to select the input source ([page 25](#)).

5 **Input function buttons**

Use to select the input source to this receiver ([page 25](#)). This will enable you to control other components with the remote control ([page 54](#)).

6 **Listening mode buttons**

AUTO/DIRECT – Switches between Auto surround mode ([page 33](#)) and Stream Direct playback ([page 34](#)).

ALC/STANDARD SURR – Press for standard decoding and to switch between the modes of **PRO** Pro Logic II, **PRO** Pro Logic IIx, **PRO** Pro Logic IIz and NEO:6, and the Auto level control stereo mode ([page 33](#)).

ADV SURR – Switches between the various surround modes ([page 34](#)).

7 **Receiver and component control buttons**

The following button controls can be accessed after you have selected the corresponding input function button (**BD**, **DVD**, etc.).

Press **RECEIVER** first to access:

AUDIO PARAMETER – Use to access the Audio options ([page 36](#)).

HOME MENU – Press to access the Home Menu ([page 46](#)).

RETURN – Confirm and exit the current menu screen.

Press **BD**, **DVD** or **DVR/BDR** first to access:

TOP MENU – Displays the disc 'top' menu of a Blu-ray Disc/DVD.

HOME MENU – Displays the HOME MENU screen.

RETURN – Confirm and exit the current menu screen.

MENU – Displays the TOOLS menu of Blu-ray Disc player.

Press **TUNER** first to access:

TOOLS – Memorizes stations for recall ([page 32](#)), also used to change the name ([page 32](#)).

BAND – Switches between AM, FM ST (stereo) and FM MONO radio bands ([page 32](#)).

Press **iPod/USB** first to access:

iPod CTRL – Switches between the iPod controls and the receiver controls ([page 27](#)).

8 **↑/↓/←/→ (TUNE ↑/↓, PRESET ←/→), ENTER**

Use the arrow buttons when setting up your surround sound system ([page 46](#)). Also used to control Blu-ray Disc/DVD menus/options.

Use **TUNE ↑/↓** can be used to find radio frequencies and **PRESET ←/→** can be used to select preset radio stations ([page 32](#)).

9 **Component control buttons**

The main buttons (**▶**, **■**, etc.) are used to control a component after you have selected it using the input function buttons. The controls above these buttons can be accessed after you have selected the corresponding input function button (**BD**, **DVD** and **CD**). These buttons also function as described below.

Press **RECEIVER** first to access:

BASS +/-, **TRE +/-** – Use to adjust Bass or Treble.

- These controls are disabled when the listening mode is set to **DIRECT** or **PURE DIRECT**.

- When the front speaker is set at **SMALL** in the Speaker Setting (or automatically via the Auto MCACC setup) and the X.Over is set above 150 Hz, the subwoofer channel level will be adjusted by pressing **BASS +/-** ([page 47](#)).

10 Number buttons and other component controls

Use the number buttons to directly select a radio frequency (page 32) or the tracks on a CD, etc. There are other buttons that can be accessed after **RECEIVER** is pressed. (For example **MIDNIGHT**, etc.)

EQ – Press to switch on/off Acoustic Calibration EQ setting (page 34).

PHASE – Press to switch on/off Phase Control (page 35).

SIGNAL SEL – Press to select the audio input signal of the component to play back (page 25).

S.RETRIEVER – Press to restore CD quality sound to compressed audio sources (page 34).

SB CH – Press to select **ON**, **AUTO** or **OFF** the surround back channel (page 35).

CH SELECT – Press repeatedly to select a channel, then use **LEV +/-** to adjust the level (page 48).

LEV +/- – Use to adjust the channel level.

MIDNIGHT – Switches to Midnight or Loudness listening (page 36).

SPEAKERS – See [Switching the speaker terminal on page 14](#).

DIMMER – Dims or brightens the display. The brightness can be controlled in four steps.

11 SOURCE

Press to turn on/off other components connected to the receiver (page 54).

12 TV CONTROL buttons

These buttons are dedicated to control the TV assigned to the **TV** button. Thus if you only have one TV to hook up to this system assign it to the **TV** button (page 55).

⏻ – Use to turn on/off the power of the TV.

INPUT – Use to select the TV input signal.

CH +/- – Use to select channels.

VOL +/- – Use to adjust the volume on your TV.

13 +Favorite

Press while a song is being played back or stopped. The selected song is then registered in the Favorites folder (page 40).

14 VOLUME +/-

Use to set the listening volume.

15 MUTE

Mutes/unmutes the sound.

16 DISP

Switches the display of this unit. The listening mode, sound volume, Speaker System (*V SX-1022*)/Pre Out (*V SX-822*) setting or input name can be checked by selecting an input source.

- The Speaker System/Pre Out setting may or may not be displayed, depending on the input source you have selected.

Loading the batteries

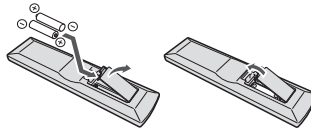

The batteries included with the unit are to check initial operations; they may not last over a long period. We recommend using alkaline batteries that have a longer life.

CAUTION

- Incorrect use of batteries may result in such hazards as leakage and bursting. Observe the following precautions:
 - Never use new and old batteries together.
 - Insert the plus and minus sides of the batteries properly according to the marks in the battery case.
 - Batteries with the same shape may have different voltages. Do not use different batteries together.
 - When disposing of used batteries, please comply with governmental regulations or environmental public institution's rules that apply in your country or area.
 - Do not use or store batteries in direct sunlight or other excessively hot place, such as inside a car or near a heater. This can cause batteries to leak, overheat, explode or catch fire. It can also reduce the life or performance of batteries.

Operating range of remote control

The remote control may not work properly if:

- There are obstacles between the remote control and the receiver's remote sensor.
- Direct sunlight or fluorescent light is shining onto the remote sensor.
- The receiver is located near a device that is emitting infrared rays.
- The receiver is operated simultaneously with another infrared remote control unit.

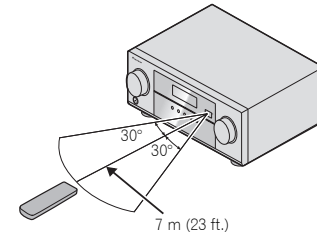

Determining the speakers' application

By connecting the left and right front speakers (L/R), the center speaker (C), the left and right surround speakers (SL/SR), the left and right surround back speakers (SBL/SBR) (or the left and right front height speakers (FHL/FHR)), and the subwoofer (SW), a surround sound system up to 7.1 channel can be enjoyed.

The 5.1 channel surround system is the most commonly-used in home theaters. To achieve the best possible surround sound, install your speakers as shown below.

5.1 channel surround system:

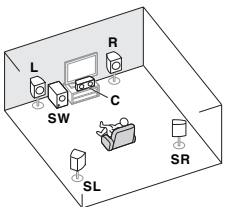

6.1 channel surround (Surround back) system:

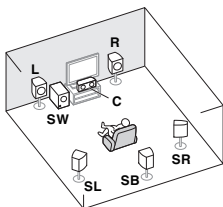

7.1 channel surround (Surround back) system:

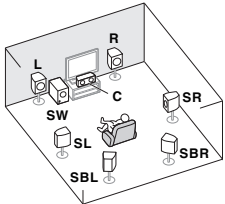

7.1 channel surround (Front height) system:

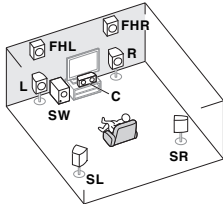

Important

- VSX-1022 only:** Both the surround back speakers and the front height speakers can be connected at the same time. In this case, sound will be output from either the front height speaker or the surround back speaker depending on which one was selected in the **Speaker System** setting (see [The Speaker System setting \(VSX-1022 only\) on page 49](#)).
- VSX-822 only:** **To connect the surround back or front height speakers, an additional amplifier is required.** Connect the additional amplifier to the **PRE OUT SURR BACK/FRONT HEIGHT** outputs of this unit and connect the surround back or front height speakers to the additional amplifier (see [Connect the surround back or front height speakers \(In case of VSX-822\) on page 12](#)).

VSX-1022 only: Another way, you can use the speakers connected to the B speaker terminals to listen to stereo playback in another room. See [Switching the speaker terminal on page 14](#) for the listening options with this setup.

- You will not be able to connect the B speakers if you connect the front height speakers in the main zone.** Further, if you use the B speakers, a 5.1 ch playback will be the maximum in the main zone. (No sound is output from the surround back speaker.)

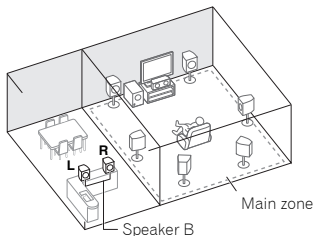

Some tips for improving sound quality

Where you put your speakers in the room has a big effect on the quality of the sound. The following guidelines should help you to get the best sound from your system.

- It is best to angle the speakers towards the listening position. The angle depends on the size of the room. Use less of an angle for bigger rooms.
- Refer to the chart below for placement of speakers you intend to connect.

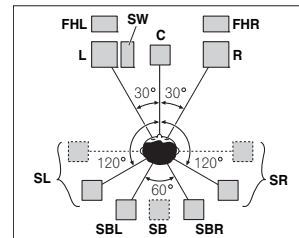

- Place the surround speakers at 120° from the center. If you, (1) use the surround back speaker, and, (2) don't use the front height speakers, we recommend placing the surround speaker right beside you.
- If you intend to connect only one surround back speakers, place it directly behind you.
- If the surround speakers cannot be set directly to the side of the listening position with a 7.1-channel system, the surround effect can be enhanced by turning off the Up Mix function (see [Setting the Up Mix function on page 35](#)).
- For the best stereo effect, place the front speakers 2 m to 3 m apart, at equal distance from the TV.
- If you're using a center speaker, place the front speakers at a wider angle. If not, place them at a narrower angle.
- Place the center speaker above or below the TV so that the sound of the center channel is localized at the TV screen. Also, make sure the center speaker does not cross the line formed by the leading edge of the front left and right speakers.

- Surround and surround back speakers should be positioned 60 cm to 90 cm higher than your ears and tilted slightly downward. Make sure the speakers don't face each other. For DVD-Audio, the speakers should be more directly behind the listener than for home theater playback.
- Try not to place the surround speakers farther away from the listening position than the front and center speakers. Doing so can weaken the surround sound effect.
- Place the left and right front height speakers at least one meter directly above the left and right front speakers.
- If you're going to place speakers around your CRT TV, use shielded speakers or place the speakers at a sufficient distance from your CRT TV.
- The subwoofer can be placed on the floor. Ideally, the other speakers should be at about ear-level when you're listening to them. Putting the speakers on the floor (except the subwoofer), or mounting them very high on a wall is not recommended.
- When not connecting a subwoofer, connect speakers with low frequency reproduction capabilities to the front channel. (The subwoofer's low frequency component is played from the front speakers, so the speakers could be damaged.)
- **After connecting, be sure to conduct the Auto MCACC (speaker environment setting) procedure.**
See [Automatically setting up for surround sound \(MCACC\) on page 23](#).

CAUTION

- Make sure that all speakers are securely installed. This not only improves sound quality, but also reduces the risk of damage or injury resulting from speakers being knocked over or falling in the event of external shocks such as earthquakes.

Connecting the speakers

The receiver will work with just two stereo speakers (the front speakers in the diagram) but using at least three speakers is recommended, and a complete setup is best for surround sound.

Make sure you connect the speaker on the right to the right (R) terminal and the speaker on the left to the left (L) terminal. Also make sure the positive and negative (+/-) terminals on the receiver match those on the speakers.

You can use speakers with a normal impedance between 6 Ω and 16 Ω .

Be sure to complete all connections before connecting this unit to the AC power source.

Bare wire connections

- 1 Twist exposed wire strands together.
- 2 Loosen terminal and insert exposed wire.
- 3 Tighten terminal.

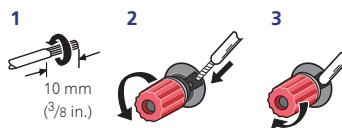

Connect the wires to the B-Speakers terminals of the VSX-1022 as shown below:

- 1 Twist exposed wire strands together.
- 2 Push open the tabs and insert exposed wire.
- 3 Release the tabs.

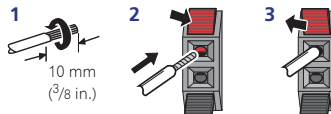

CAUTION

- These speaker terminals carry **HAZARDOUS LIVE voltage**. To prevent the risk of electric shock when connecting or disconnecting the speaker cables, disconnect the power cord before touching any uninsulated parts.
- Make sure that all the bare speaker wire is twisted together and inserted fully into the speaker terminal. If any of the bare speaker wire touches the back panel it may cause the power to cut off as a safety measure.

Connect the surround back or front height speakers (In case of VSX-1022)

The Speaker System setting must be set if the above connections are performed. Select **Surr.Back** if the surround back speaker is connected and **Height** if the front height speaker is connected (If neither the surround back speaker nor the front height speaker is connected, either setting will suffice) (see [The Speaker System setting \(VSX-1022 only\) on page 49](#)).

- When using only one surround back speaker, connect it to the **SURROUND BACK L (Single)** terminals.

Connect the surround back or front height speakers (In case of VSX-822)

Connect the **PRE OUT SURR BACK/FRONT HEIGHT** outputs of the unit and additional amplifier to add a surround back or front height speaker.

The Pre Out setting must be set if the above connections are performed. Select **Surr.Back** if the surround back speaker is connected and **Height** if the front height speaker is connected (If neither the surround back speaker nor the front height speaker is connected, either setting will suffice) (see [The Pre Out Setting \(VSX-822 only\) on page 50](#)).

- You can use the additional amplifier on the surround back channel pre-outs for a single speaker as well. In this case plug the amplifier into the left (**L (Single)**) terminal only.

VSX-1022 connection diagram

The front height terminals can also be used for Speaker B.

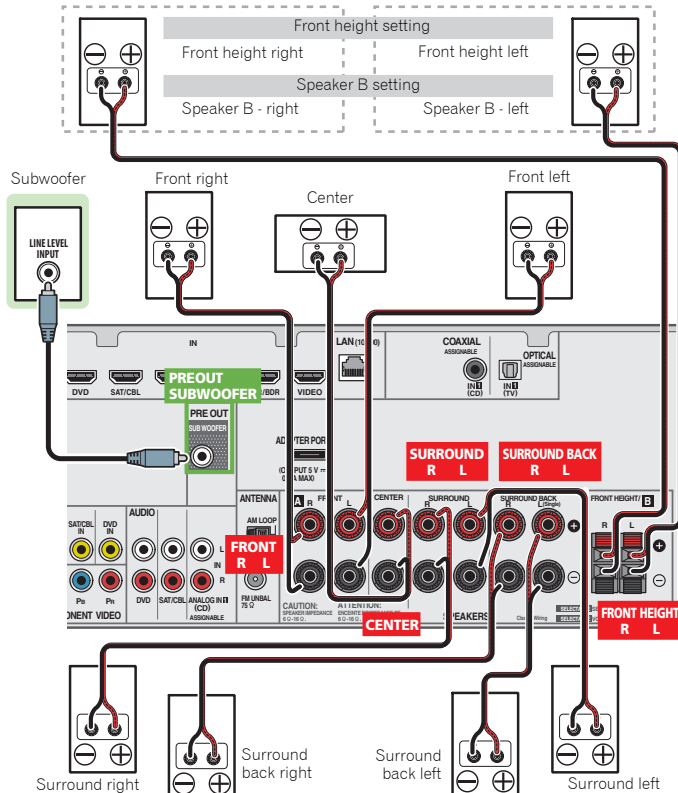

When using only one surround back speaker, connect it to the **SURROUND BACK L (Single)** terminals.

VSX-822 connection diagram

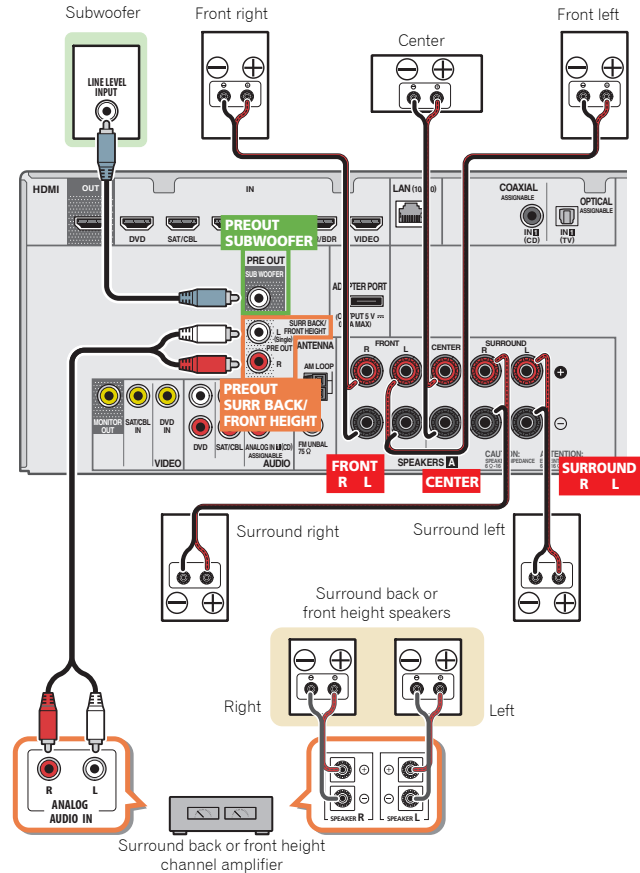

Switching the speaker terminal

Use **SPEAKERS** button to change the speaker system on or off. When the **SP OFF** is selected, no sound is output from the speakers connected to this receiver.

VSX-1022 only: If you selected **Surr.Back** in [The Speaker System setting \(VSX-1022 only\)](#) on page 49, you can switch between speakers using the **SPEAKERS** button. If you selected **Height**, the button will simply switch your main speaker terminal on or off. The options below are for the **Surr.Back** setting only.

- ▶ Use the **SPEAKERS** button on the front panel to select a speaker terminal setting.



Press repeatedly to choose a speaker terminal option:

- **SP▶A** – Sound is output from the speakers connected to the A-speaker terminals and **PRE OUT SURR BACK/FRONT HEIGHT** (*VSX-822 only*) (multichannel playback is possible).
- **SP▶B** (*VSX-1022 only*) – Sound is output from the two speakers connected to the B-speaker terminals (only stereo playback is possible).
- **SP▶AB** (*VSX-1022 only*) – Sound is output from the A-speaker terminals, the two speakers in the B-speaker terminals, and the subwoofer. Multichannel sources are downmixed only when the **STEREO** or **STEREO ALC** mode is selected for stereo output from A- and B-speaker terminals.
- **SP▶** – No sound is output from the speakers.

Note

- *VSX-1022 only:* The subwoofer output depends on the settings you made in [Speaker Setting on page 46](#). However, if **SP▶B** is selected above, no sound is heard from the subwoofer (the LFE channel is not downmixed).
- All speaker terminals are switched off (**SP▶**) when headphones are connected. **SP▶B** can be selected even when headphones are connected for VSX-1022.

Making cable connections

Make sure not to bend the cables over the top of this unit (as shown in the illustration). If this happens, the magnetic field produced by the transformers in this unit may cause a humming noise from the speakers.

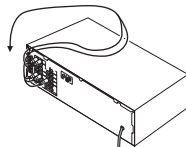

Important

- Before making or changing connections, switch off the power and disconnect the power cord from the AC outlet.
- Before unplugging the power cord, switch the power into standby.

HDMI cables

Both video and sound signals can be transmitted simultaneously with one cable. If connecting the player and the TV via this receiver, for both connections, use HDMI cables.

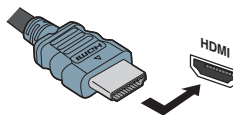

Be careful to connect the terminal in the proper direction.

Note

- Set the HDMI parameter in [Setting the Audio options on page 36](#) to **THRU** (THROUGH) and set the input signal in [Selecting the audio input signal on page 25](#) to **HDMI**, if you want to hear HDMI audio output from your TV (no sound will be heard from this receiver).

- If the video signal does not appear on your TV, try adjusting the resolution settings on your component or display. Note that some components (such as video game units) have resolutions that may not be displayed. In this case, use a (analog) composite connection.
- When the video signal from the HDMI is 480i, 480p, 576i or 576p, Multi Ch PCM sound and HD sound cannot be received.

About HDMI

The HDMI connection transfers uncompressed digital video, as well as almost every kind of digital audio that the connected component is compatible with, including DVD-Video, DVD-Audio, SACD, Dolby Digital Plus, Dolby TrueHD, DTS-HD Master Audio (see below for limitations), Video CD/ Super VCD and CD.

This receiver incorporates High-Definition Multimedia Interface (HDMI[®]) technology. This receiver supports the functions described below through HDMI connections.

- Digital transfer of uncompressed video (contents protected by HDCP (1080p/24, 1080p/60, etc.))
- 3D signal transfer
- Deep Color signal transfer
- x.v.Color signal transfer
- Audio Return Channel
- Input of multi-channel linear PCM digital audio signals (192 kHz or less) for up to 8 channels
- Input of the following digital audio formats:
 - Dolby Digital, Dolby Digital Plus, DTS, High bitrate audio (Dolby TrueHD, DTS-HD Master Audio), DVD-Audio, CD, SACD (DSD 2 ch only), Video CD, Super VCD
- Synchronized operation with components using the **Control** with HDMI function (see [Control with HDMI function on page 52](#))

Note

- Use a High Speed HDMI® cable. If HDMI cable other than a High Speed HDMI® cable is used, it may not work properly.
- When an HDMI cable with a built-in equalizer is connected, it may not operate properly.
- 3D, Deep Color, x.v.Color signal transfer and Audio Return Channel are only possible when connected to a compatible component.
- HDMI format digital audio transmissions require a longer time to be recognized. Due to this, interruption in the audio may occur when switching between audio formats or beginning playback.
- Turning on/off the device connected to this unit's HDMI OUT terminal during playback, or disconnecting/connecting the HDMI cable during playback, may cause noise or interrupted audio.

HDMI, the HDMI Logo and High-Definition Multimedia Interface are trademarks or registered trademarks of HDMI Licensing, LLC in the United States and other countries.

"x.v.Color" and **x.v.Color** are trademarks of Sony Corporation.

Analog audio cables

Use stereo RCA phono cables to connect analog audio components. These cables are typically red and white, and you should connect the red plugs to R (right) terminals and white plugs to L (left) terminals.

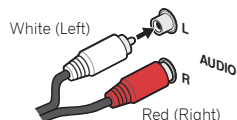
**Digital audio cables**

Commercially available coaxial digital audio cables or optical cables should be used to connect digital components to this receiver.

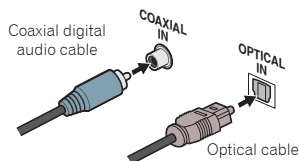
**Note**

- When connecting optical cables, be careful when inserting the plug not to damage the shutter protecting the optical socket.
- When storing optical cable, coil loosely. The cable may be damaged if bent around sharp corners.
- You can also use a standard RCA video cable for coaxial digital connections.

Video cables**Standard RCA video cables**

These cables are the most common type of video connection and are used to connect to the composite video terminals. The yellow plugs distinguish them from cables for audio.

**Component video cables (VSX-1022 only)**

Use component video cables to get the best possible color reproduction of your video source. The color signal of the TV is divided into the luminance (Y) signal and the color (Pb and Pr) signals and then output. In this way, interference between the signals is avoided.

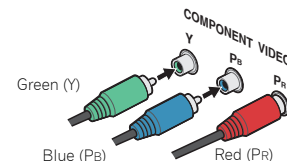

About the video converter (VSX-1022 only)

The video converter ensures that all video sources are output from the **HDMI OUT** terminal.

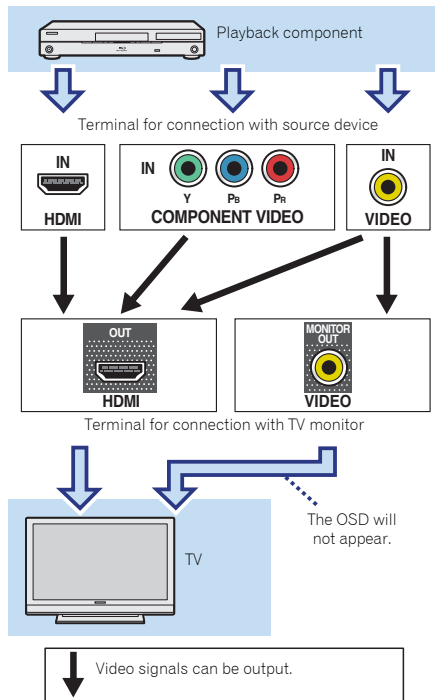

- If the video signal does not appear on your TV, try adjusting the resolution settings on your component or display. Note that some components (such as video game units) have resolutions that may not be converted. In this case, try switching Video Converter **OFF** (see [Video Converter on page 49](#)).
- The signal input resolutions that can be converted from the component video input for the HDMI output are 480i/576i, 480p/576p, 720p and 1080i. 1080p signal cannot be converted.

This item incorporates copy protection technology that is protected by U.S. patents and other intellectual property rights of Rovi Corporation. Reverse engineering and disassembly are prohibited.

Note

- If several video components are assigned to the same input function, the converter gives priority to HDMI, component, then composite (in that order).

About video outputs connection (VSX-822 only)

This receiver is not loaded with a video converter. When you use HDMI cables for connecting to the input device, the same cables should be used for connecting to the TV.

The signals input from the analog (composite) video inputs of this unit will not be output from the **HDMI OUT** terminal.

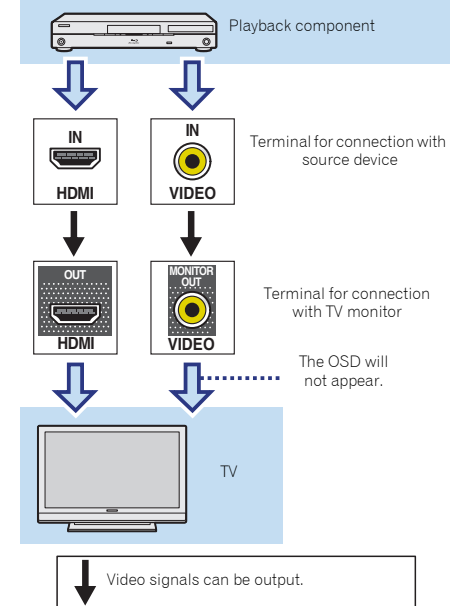

Connecting a TV and playback components

Connecting using HDMI

If you have an HDMI or DVI (with HDCP) equipped component (Blu-ray Disc player, etc.), you can connect it to this receiver using a commercially available HDMI cable.

If the TV and playback components support the **Control** with HDMI feature, the convenient **Control** with HDMI functions can be used (see [Control with HDMI function on page 52](#)).

- The following connection/setting is required to listen to the sound of the TV over this receiver.
 - If the TV does not support the HDMI Audio Return Channel function, connect the receiver and TV with audio cables (as shown).
 - If the TV supports the HDMI Audio Return Channel function, the sound of the TV can be input to the receiver via the HDMI terminal, so there is no need to connect an audio cable. In this case, set **ARC** at **HDMI Setup** to **ON** (see [HDMI Setup on page 52](#)).

Note

- In order to listen to the audio from the TV that is connected to this receiver using an analog audio cables, set-up for analog audio input is required (see [The Input Assign menu on page 49](#)).

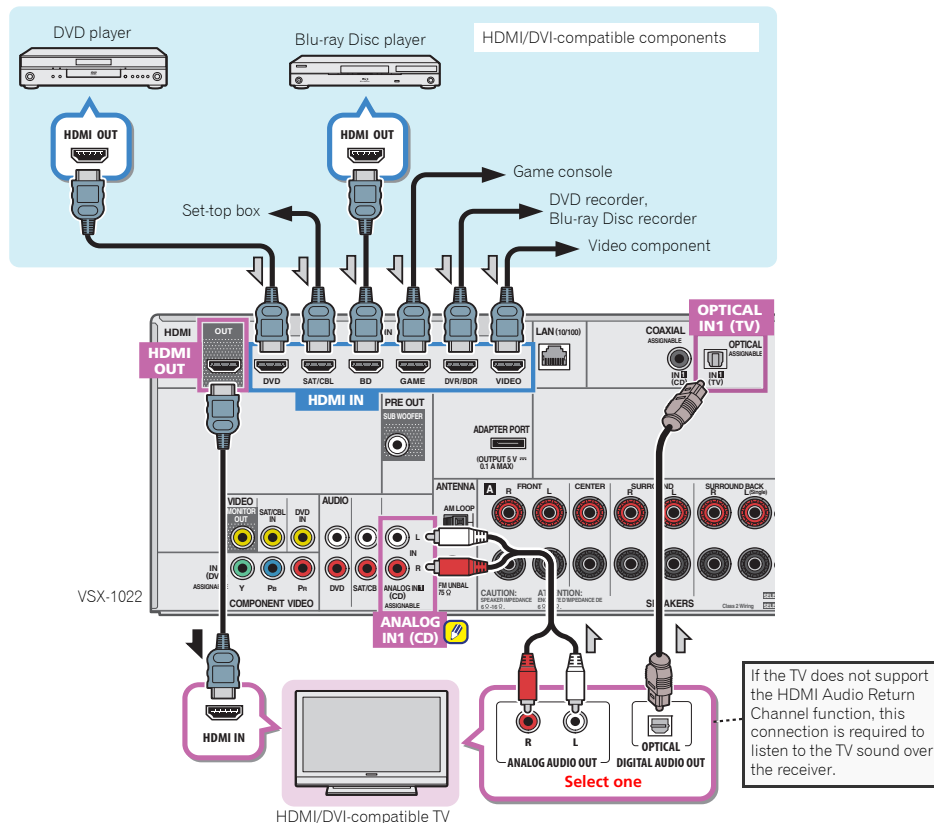

Connecting your TV with no HDMI input

This diagram shows connections of a TV (with no HDMI input) and DVD player (or other playback component) to the receiver.

- With these connections, the picture is not output to the TV even if the DVD player is connected with an HDMI cable. Connect the DVD player's video signals using a composite cable.
- In order to listening to HD audio with this receiver, connect an HDMI cable, and use analog video cable for video signal input. Depending on the player, it may not be possible to output video signals to both HDMI and other video output (composite, etc.) simultaneously, and it may be necessary to make video output settings. Please refer to the operating instructions supplied with your player for more information.

Important

- When the receiver and TV are connected by composite cable, the OSD function allowing display of the receiver's settings, operations, etc., on the TV's screen cannot be used. In this case, watch the receiver's front panel display while performing the various operations and making settings.

Note

- In order to listen to the audio from the TV that is connected to this receiver using an analog audio cables, set-up for analog audio input is required (see [The Input Assign menu on page 49](#)).
- Only one component can be connected to both the optical input terminal and coaxial input terminal. If connecting other devices, please use a different method to connect the audio.

In order to listen to the audio from the source component that is connected to this receiver using an optical cable or a coaxial cable, first, switch to the **DVD** (DVD player) or **SAT/CBL** (set-top box), then use **RECEIVER** and **SIGNAL SEL** to choose the audio signal **O1** (OPTICAL1) or **C1** (COAXIAL1) (see [Selecting the audio input signal on page 26](#)).

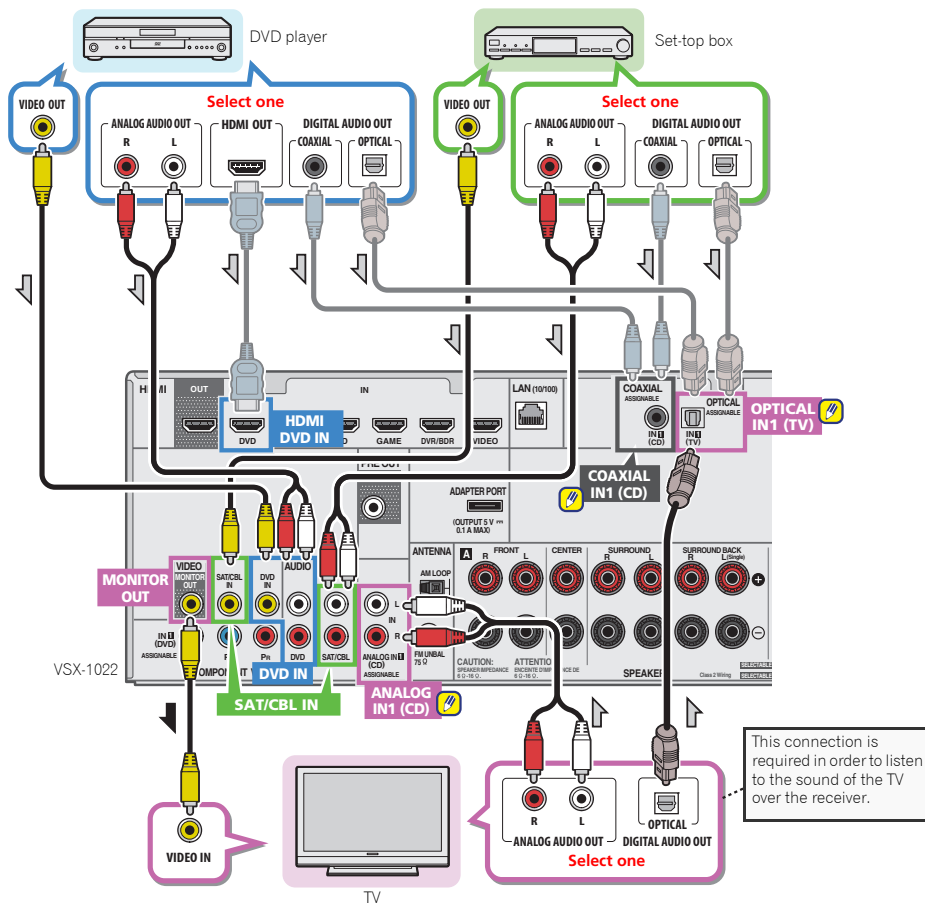

Connecting your DVD player with no HDMI output (VSX-1022 only)

This diagram shows connections of a TV (with HDMI input) and DVD player (or other playback component with no HDMI output) to the receiver.

- The following connection/setting is required to listen to the sound of the TV over this receiver.
 - If the TV does not support the HDMI Audio Return Channel function, connect the receiver and TV with audio cables (as shown).
 - If the TV supports the HDMI Audio Return Channel function, the sound of the TV can be input to the receiver via the HDMI terminal, so there is no need to connect an audio cable. In this case, set **ARC at HDMI Setup to ON** (see [HDMI Setup on page 52](#)).

Note

- In order to listen to the audio from the TV that is connected to this receiver using an analog audio cables, set-up for analog audio input is required (see [The Input Assign menu on page 49](#)).
- Only one component can be connected to both the optical input terminal and coaxial input terminal. If connecting other devices, please use a different method to connect the audio.

In order to listen to the audio from the source component that is connected to this receiver using an optical cable or a coaxial cable, first, switch to the **DVD** (DVD player) or **SAT/CBL** (set-top box), then use **RECEIVER** and **SIGNAL SEL** to choose the audio signal **O1** (OPTICAL1) or **C1** (COAXIAL1) (see [Selecting the audio input signal on page 25](#)).

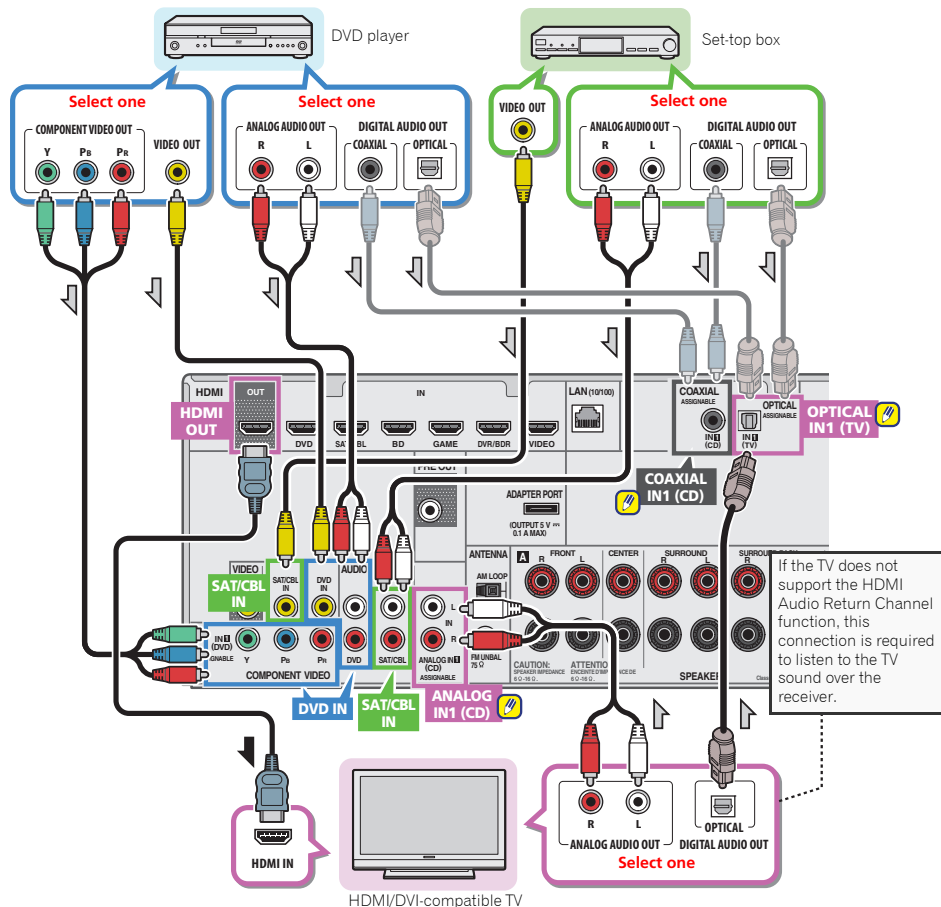

Connecting optional Bluetooth® ADAPTER

When the *Bluetooth* ADAPTER (Pioneer Model No. AS-BT100 or AS-BT200) is connected to this unit, a product equipped with *Bluetooth* wireless technology (portable cell phone, digital music player, etc.) can be used to listen to music wirelessly.

▶ Connect a Bluetooth ADAPTER to the ADAPTER PORT terminal on the rear panel.

- For instructions on playing the *Bluetooth* wireless technology device, see [Pairing the Bluetooth ADAPTER and Bluetooth wireless technology device on page 30](#).

🔔 Important

- Do not move the receiver with the *Bluetooth* ADAPTER connected. Doing so could cause damage or faulty contact.

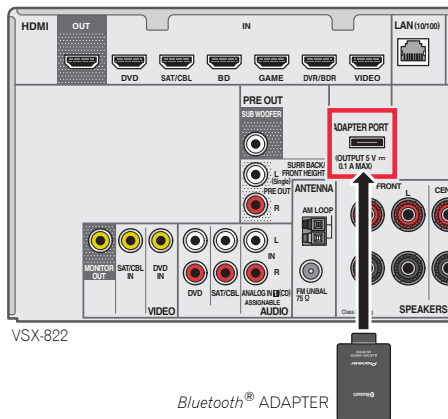

Connecting to the network through LAN interface

By connecting this receiver to the network via the LAN terminal, you can listen to Internet radio stations. To listen to Internet radio stations, you must sign a contract with an ISP (Internet Service Provider) beforehand.

When connected in this way, you can play audio files stored on the components on the local network, including your computer.

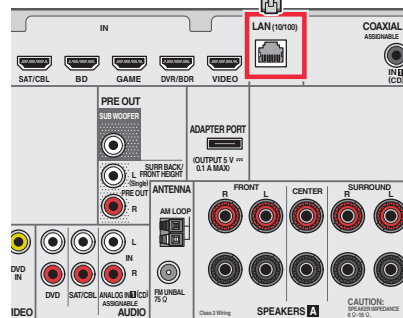
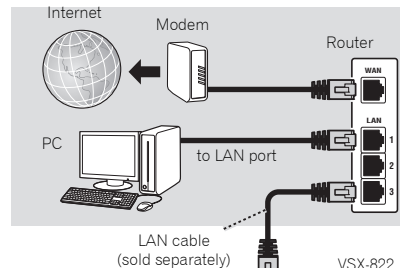

Connect the LAN terminal on this receiver to the LAN terminal on your router (with or without the built-in DHCP server function) with a straight LAN cable (CAT 5 or higher).

Turn on the DHCP server function of your router. In case your router does not have the built-in DHCP server function, it is necessary to set up the network manually. For details, see [The Network Setup menu on page 41](#).

Note

- Refer to the operation manual of the equipment you have as the connected equipment and connection method may differ depending on your Internet environment.
- When using a broadband Internet connection, a contract with an Internet service provider is required. For more details, contact your nearest Internet service provider.

Connecting antennas

Connect the AM loop antenna and the FM wire antenna as shown below. To improve reception and sound quality, connect external antennas (see [Using external antennas](#) below).

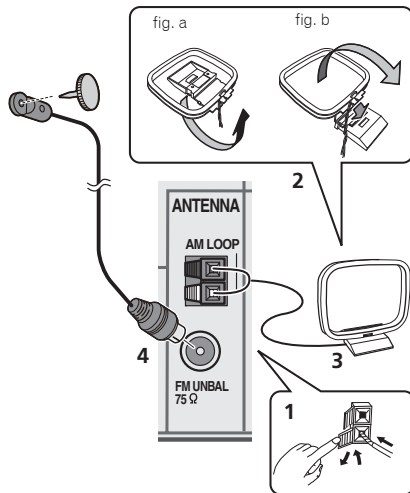

1 Push open the tabs, then insert one wire fully into each terminal, then release the tabs to secure the AM antenna wires.

2 Fix the AM loop antenna to the attached stand. To fix the stand to the antenna, bend in the direction indicated by the arrow (fig. a) then clip the loop onto the stand (fig. b).

3 Place the AM antenna on a flat surface and in a direction giving the best reception.

4 Connect the FM wire antenna into the FM antenna socket.

For best results, extend the FM antenna fully and fix to a wall or door frame. Don't drape loosely or leave coiled up.

Using external antennas

To improve FM reception

Use an F connector (not supplied) to connect an external FM antenna.

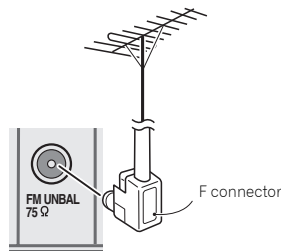

To improve AM reception

Connect a 5 m to 6 m (16 ft. to 20 ft.) length of vinyl-coated wire to the AM antenna terminal without disconnecting the supplied AM loop antenna.

For the best possible reception, suspend horizontally outdoors.

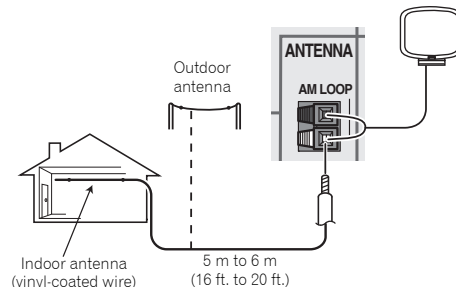

Connecting an iPod

This receiver has a dedicated iPod terminal that will allow you to control playback of audio content from your iPod using the controls of this receiver.

► **Switch the receiver into standby, and then use the iPod cable to connect your iPod to the iPod iPhone iPad USB terminal on the front panel of this receiver.**

- For the cable connection, refer to also the operating instructions for iPod.
- For instructions on playing the iPod, see [Playing an iPod on page 27](#).

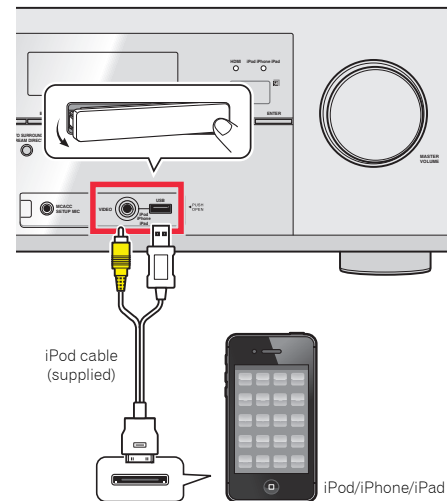

Connecting a USB device

It is possible to play audio and photo files by connecting USB devices to this receiver.

► **Switch the receiver into standby then connect your USB device to the USB terminal on the front panel of this receiver.**

- This receiver does not support a USB hub.
- For instructions on playing the USB device, see [Playing a USB device on page 28](#).

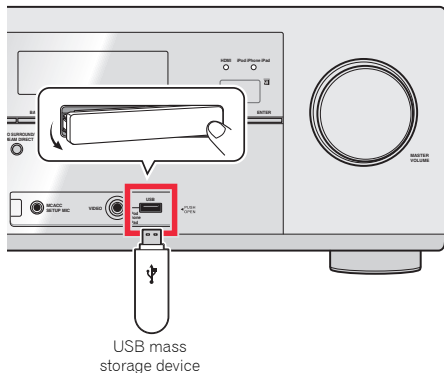

Plugging in the receiver

Only plug in after you have connected all your components to this receiver, including the speakers.

► **Plug the AC power cord into a convenient AC power outlet.**

⚠ CAUTION

- Handle the power cord by the plug part. Do not pull out the plug by tugging the cord, and never touch the power cord when your hands are wet, as this could cause a short circuit or electric shock. Do not place the unit, a piece of furniture, or other object on the power cord or pinch the cord in any other way. Never make a knot in the cord or tie it with other cables. The power cords should be routed so that they are not likely to be stepped on. A damaged power cord can cause a fire or give you an electric shock. Check the power cord once in a while. If you find it damaged, ask your nearest Pioneer authorized independent service company for a replacement.
- The receiver should be disconnected by removing the mains plug from the wall socket when not in regular use, e.g., when on vacation.

📖 Note

- After this receiver is connected to an AC outlet, a 2 second to 10 second HDMI initialization process begins. You cannot carry out any operations during this process. The **HDMI** indicator in the front panel display blinks during this process, and you can turn on this receiver once it has stopped blinking. When you set the **Control** with HDMI to **OFF**, you can skip this process. For details about the **Control** with HDMI feature, see [HDMI Setup on page 52](#).

Canceling the demo display

The display on the front panel shows various information (demo displays) when the receiver is not operating. You can turn off the demo display. For details, see [The FL Demo Mode menu on page 51](#).

- The demo mode is canceled automatically when the Auto MCACC setup is performed (see below).

Automatically setting up for surround sound (MCACC)

The Auto Multi-Channel Acoustic Calibration (MCACC) setup measures the acoustic characteristics of your listening area, taking into account ambient noise, speaker size and distance, and tests for both channel delay and channel level. After you have set up the microphone provided with your system, the receiver uses the information from a series of test tones to optimize the speaker settings and equalization for your particular room.

CAUTION

- The test tones used in the Auto MCACC setup are output at high volume.

Important

- The OSD will not appear if you have connected using the composite output to your TV. Use HDMI connection for Auto MCACC setup.
- The Auto MCACC setup will overwrite any existing speaker settings you've made.
- Before using the Auto MCACC setup, the **NETRADIO**, **PANDORA**, **M.SERVER**, **FAVORITE**, **iPod/USB** or **ADAPTER** input should not be selected as an input source.
- VSX-1022 only:* When both the surround back speaker and the front height speaker are connected, conduct Auto MCACC setup twice: once with the Speaker System setting is in **Surr.Back** and once with the Speaker System setting is in **Height**. (There is no need to conduct Auto MCACC setup every time the Speaker System setting is changed.)

- VSX-822 only:* If you connected either the surround back speaker or the front height speaker, make sure that the Pre Out setting is correctly set before performing the Auto MCACC setup (see [page 50](#)). (Here is an explanation using the OSD screen for a surround back speaker connection.)

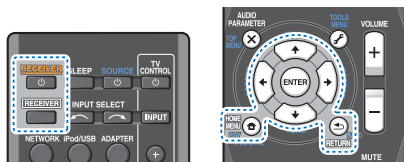

- Switch on the receiver and your TV.
- Switch the TV input to the input that connects this receiver to the TV through the corresponding HDMI cable.
- Connect the microphone to the MCACC SETUP MIC jack on the front panel.

Make sure there are no obstacles between the speakers and the microphone.

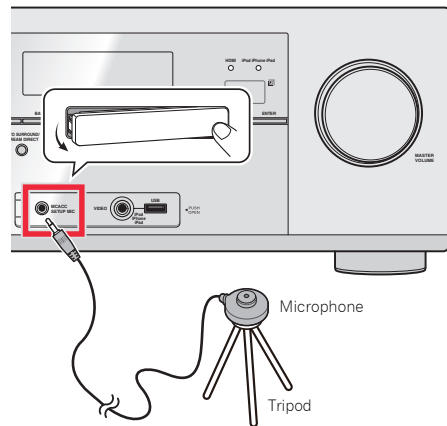

If you have a tripod, use it to place the microphone so that it's about ear level at your normal listening position. Otherwise, place the microphone at ear level using a table or a chair.

- Press **RECEIVER** on the remote control, then press the **HOME MENU** button.

The Home Menu appears on your TV. Use **↑/↓/←/→** and **ENTER** on the remote control to navigate through the screens and select menu items. Press **RETURN** to exit the current menu.

- Press **HOME MENU** at any time to exit the Home Menu. If you cancel the Auto MCACC setup at any time, the receiver automatically exits and no settings will be made.
- The screensaver automatically starts after three minutes of inactivity.

5 Select 'Auto MCACC' from the Home Menu, then press ENTER.

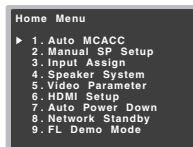

VSX-1022

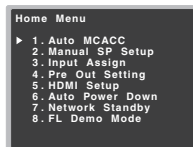

VSX-822

- **Mic In!** blinks when the microphone is not connected to MCACC SETUP MIC jack.

Try to be as quiet as possible after pressing **ENTER**. The system outputs a series of test tones to establish the ambient noise level.

6 Follow the instructions on-screen.

- Make sure the microphone is connected.
- Make sure the subwoofer is on and the volume is turned up.
- When using surround back or front height speakers, turn on the power to the amplifier to which the surround back or front height speakers are connected, and adjust the sound level to the desired level.
- See below for notes regarding background noise and other possible interference.

7 Wait for the test tones to finish.

A progress report is displayed on-screen while the receiver outputs test tones to determine the speakers present in your setup. Try to be as quiet as possible while it's doing this.

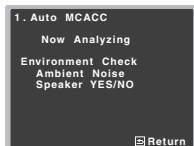

- For correct speaker settings, do not adjust the volume during the test tones.

8 Confirm the speaker configuration.

The configuration shown on-screen should reflect the actual speakers you have.

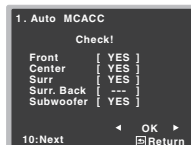

- With error messages (such as **Too much ambient noise**) select **RETRY** after checking for ambient noise (see [Other problems when using the Auto MCACC setup below](#)).

If the speaker configuration displayed isn't correct, use **↑/↓** to select the speaker and **←/→** to change the setting. When you're finished, go to the next step. If you see an error message (**ERR**) in the right side column, there may be a problem with the speaker connection. If selecting **RETRY** doesn't fix the problem, turn off the power and check the speaker connections.

9 Make sure 'OK' is selected, then press ENTER.

If the screen in step 8 is left untouched for 10 seconds and **ENTER** is not pressed in step 9, the Auto MCACC setup will start automatically as shown.

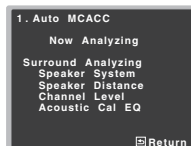

A progress report is displayed on-screen while the receiver outputs more test tones to determine the optimum receiver settings for channel level, speaker distance, and Acoustic Calibration EQ.

Again, try to be as quiet as possible while this is happening. It may take 1 to 3 minutes.

10 The Auto MCACC setup has finished! You return to the Home Menu.

The settings made in the Auto MCACC setup should give you excellent surround sound from your system, but it is also possible to adjust these settings manually using the Home Menu (starting on [page 46](#)).

Note

- Depending on the characteristics of your room, sometimes identical speakers with cone sizes of around 12 cm (5 inches) will end up with different size settings. You can correct the setting manually using the [Speaker Setting on page 46](#).
- The subwoofer distance setting may be farther than the actual distance from the listening position. This setting should be accurate (taking delay and room characteristics into account) and generally does not need to be changed.

Other problems when using the Auto MCACC setup

If the room environment is not optimal for the Auto MCACC setup (too much background noise, echo off the walls, obstacles blocking the speakers from the microphone) the final settings may be incorrect. Check for household appliances (air conditioner, fridge, fan, etc.), that may be affecting the environment and switch them off if necessary. If there are any instructions showing in the front panel display, please follow them.

- Some older TVs may interfere with the operation of the microphone. If this seems to be happening, switch off the TV when doing the Auto MCACC setup.

Playing a source

Here are the basic instructions for playing a source (such as a DVD disc) with your home theater system.

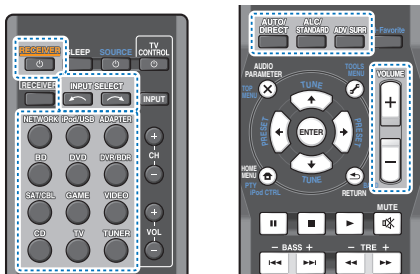

1 Switch on your system components and receiver.

Start by switching on the playback component (for example a DVD player), your TV and subwoofer (if you have one), then the receiver (press **RECEIVER**).

- Make sure the setup microphone is disconnected.

2 Switch the TV input to the input that connects this receiver.

For example, if you connected this receiver to the **VIDEO** jacks on your TV, make sure that the **VIDEO** input is now selected.

3 Press input function buttons to select the input function you want to play.

- The input of the receiver will switch over, and you will be able to operate other components using the remote control. To operate the receiver, first press **RECEIVER** on the remote control, then press the appropriate button to operate.
- The input source can also be selected by using **INPUT SELECT** buttons on the remote control, or by using the front panel **INPUT SELECTOR** dial. In this case, the remote control won't switch operational modes.

If you selected the proper input source and there is still no sound, select the audio input signal for playback (see [Selecting the audio input signal below](#)).

4 Press **AUTO/DIRECT** to select 'AUTO SURROUND' and start playback of the source.

If you're playing a Dolby Digital or DTS surround sound DVD disc, with a digital audio connection, you should hear surround sound. If you're playing a stereo source or if the connection is an analog audio connection, you will only hear sound from the front left/right speakers in the default listening mode.

It is possible to check on the front panel display whether or not surround sound playback is being performed properly.

When using a surround back speaker, **DD+PLIIx** is displayed when playing Dolby Digital 5.1-channel signals, and **DTS+NEO:6** is displayed when playing DTS 5.1-channel signals.

When not using a surround back speaker, **DD** is displayed when playing Dolby Digital signals.

If the display does not correspond to the input signal and listening mode, check the connections and settings.

Note

- You may need to check the digital audio output settings on your DVD player or digital satellite receiver. It should be set to output Dolby Digital, DTS and 88.2 kHz/96 kHz PCM (2 channel) audio, and if there is an MPEG audio option, set this to convert the MPEG audio to PCM.
- Depending on your DVD player or source discs, you may only get digital 2 channel stereo and analog sound. In this case, the receiver must be set to a multichannel listening mode if you want multichannel surround sound.

5 Use **VOLUME +/-** to adjust the volume level.

Turn down the volume of your TV so that all sound is coming from the speakers connected to this receiver.

Selecting the audio input signal

The audio input signal can be selected for each input source. Once it is set, the audio input that was selected will be applied whenever you select the input source using the input function buttons.

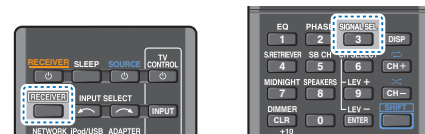

Press **RECEIVER**, then press **SIGNAL SEL** to select the audio input signal corresponding to the source component.

Each press cycles through the following:

- **H** – Selects an HDMI signal. **H** can be selected for **BD**, **DVD**, **SAT/CBL**, **DVR/BDR**, **VIDEO** or **GAME** input. For other inputs, **H** cannot be selected.
 - When the **HDMI** option in [Setting the Audio options on page 36](#) is set to **THRU**, the sound will be heard through your TV, not from this receiver.
- **A** – Selects the analog inputs.
- **C1/O1** – Selects the digital input. The coaxial 1 input is selected for **C1**, and the optical 1 audio input is selected for **O1**.

When **H** (HDMI) or **C1/O1** (digital) is selected and the selected audio input is not provided, **A** (analog) is automatically selected.

Note

- **BD**, **DVR/BDR**, **VIDEO** and **GAME** inputs are fixed to **H** (HDMI). It cannot be changed.
- For the **TV** input, only **A** (analog) or **C1/O1** (digital) can be selected. However, if the **ARC at HDMI Setup** is set to **ON**, the input is fixed to **H** (HDMI) and cannot be changed.
- When set to **H** (HDMI) or **C1/O1** (digital), **DD** lights when a Dolby Digital signal is input, and **DTS** lights when a DTS signal is input.
- When the **H** (HDMI) is selected, the **A** and **DIGITAL** indicators are off (see [page 8](#)).

- When digital input (optical or coaxial) is selected, this receiver can only play back Dolby Digital, PCM (32 kHz to 96 kHz) and DTS (including DTS 96 kHz/24 bit) digital signal formats. The compatible signals via the HDMI terminals are: Dolby Digital, DTS, SACD (DSD 2 ch only), PCM (32 kHz to 192 kHz sampling frequencies), Dolby TrueHD, Dolby Digital Plus, DTS-EXPRESS, DTS-HD Master Audio and DVD Audio (including 192 kHz). With other digital signal formats, set to **A** (analog).
- You may get digital noise when a LD or CD player compatible with DTS is playing an analog signal. To prevent noise, make the proper digital connections ([page 15](#)) and set the signal input to **C1/O1** (digital).
- Some DVD players don't output DTS signals. For more details, refer to the instruction manual supplied with your DVD player.



Tip

- In order to enjoy the picture and/or sound from devices connected to each terminal, select the input by doing the following.

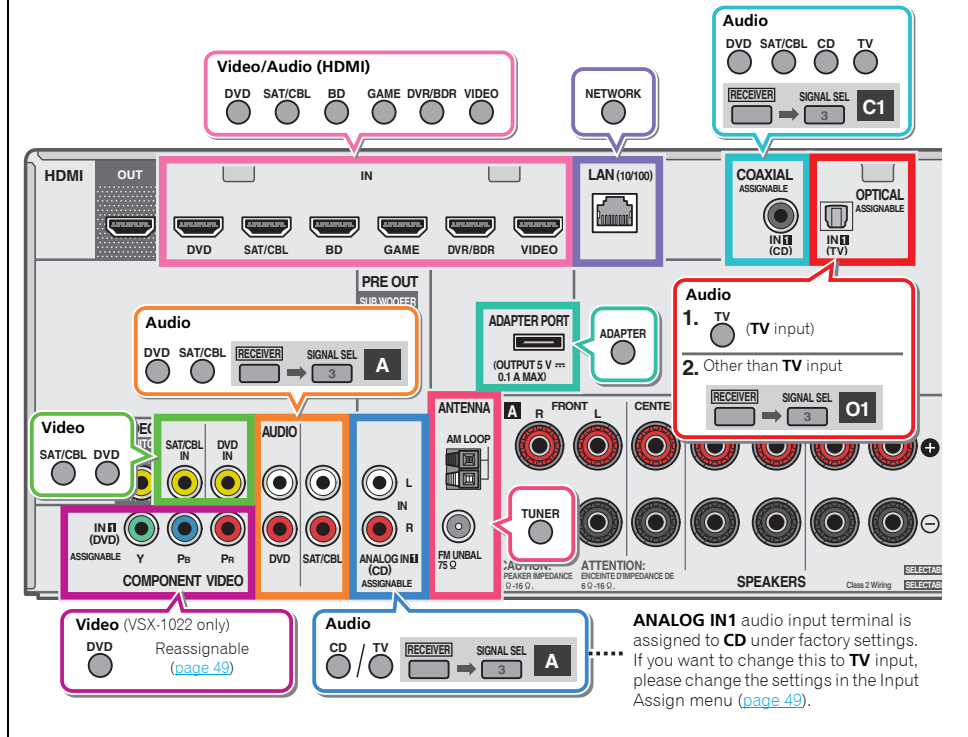

Playing an iPod

This receiver has the **iPod iPhone iPad USB** terminal that will allow you to control playback of audio content from your iPod using the controls of this receiver.

Important

- Pioneer cannot under any circumstances accept responsibility for any direct or indirect loss arising from any inconvenience or loss of recorded material resulting from the iPod failure.
- About one minute is required between turning the power on and completion of startup.

Note

- This receiver is compatible with the audio and video of the iPod nano 3G/4G/5G/6G (audio only for the iPod nano 6G), iPod touch (1G/2G/3G/4G), iPhone, iPhone 3G, iPhone 3GS, iPhone 4, iPhone 4S, iPad and iPad 2. However, some of the functions may be restricted for some models. The receiver is not compatible with the iPod shuffle.
- This receiver has been developed and tested for the software version of iPod/iPhone/iPad indicated on the website of Pioneer (<http://pioneer.jp/homeav/support/ios/na/>).
- Installing software versions other than indicated on the website of Pioneer to your iPod/iPhone/iPad may result in incompatibility with this receiver.
- iPod, iPhone and iPad are licensed for reproduction of non-copyrighted materials or materials the user is legally permitted to reproduce.
- Features such as the equalizer cannot be controlled using this receiver, and we recommend switching the equalizer off before connecting.
- Make sure the receiver is in standby when disconnecting the iPod/iPhone/iPad.

1 Switch on the receiver and your TV.

See [Connecting an iPod on page 21](#).

2 Switch the TV input so that it connects to the receiver.

- Switch the TV input to the input that connects this receiver to the TV through the corresponding HDMI cable.

3 Press iPod/USB to switch the receiver to the iPod/USB input.

When the display shows the names of folders and files, you're ready to play music from the iPod.

- If after pressing **iPod/USB** the display shows **NO DEVICE**, try switching off the receiver and reconnecting the iPod to the receiver.
- The controls of your iPod will be inoperable when connected to this receiver.

Playing back files stored on an iPod

To navigate songs on your iPod, you can take advantage of the OSD of your TV connected to this receiver.

- Note that non-roman characters in the title are displayed as '#'.
#
- This feature is not available for photos or video clips on your iPod.

Finding what you want to play

When your iPod is connected to this receiver, you can browse songs stored on your iPod by playlist, artist, album name, song name, genre or composer, similar to using your iPod directly.

1 Use **↑/↓** to select a category, then press **ENTER** to browse that category.

- To return to the previous level any time, press **RETURN**.

2 Use **←/→** to browse the selected category (e.g., albums).

- Use **←/→** to move to previous/next levels.

3 Continue browsing until you arrive at what you want to play, then press **▶** to start playback.

Tip

- If you're in the song category, you can also press **ENTER** to start playback.
- You can play all of the songs in a particular category by selecting the **All** item at the top of each category list. For example, you can play all the songs by a particular artist.

Basic playback controls

This receiver's remote control buttons can be used for basic playback of files stored on an iPod.

- Press **iPod/USB** to switch the remote control to the iPod/USB operation mode.

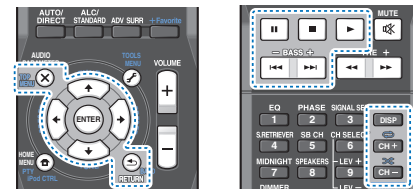

Watching photos and video content

To view photos or video on your iPod, since video control is not possible using this receiver, you must use the main controls of your iPod instead.

Important

- VX-822 only:**
 - In order to display the images or video on the iPod on the receiver, an iPod cable sold separately is required.
 - To play photos or video on your iPod, you must connect the composite **MONITOR OUT** jack and TV. The photos and video content will not appear if you have connected using the HDMI output to your TV.
- iPod photos and video content can be viewed only when the iPod is connected to the **iPod VIDEO** input on the front panel.
- This feature can only be used with an iPod having video output.

1 Press iPod CTRL to switch to the iPod controls for photo and video playback.

The receiver controls will be unavailable while you are watching iPod videos or browsing photos.

2 Press iPod CTRL again to switch back to the receiver controls when you're done.

Tip

- Change the receiver's input to the iPod in one action by pressing **iPod iPhone iPad DIRECT CONTROL** on the front panel to enable **iPod** operations on the iPod.

Playing a USB device

It is possible to play files using the USB interface on the front of this receiver.

Important

- Pioneer cannot guarantee compatibility (operation and/or bus power) with all USB mass storage devices and assumes no responsibility for any loss of data that may occur when connected to this receiver.
- About one minute is required between turning the power on and completion of startup.

Note

- Compatible USB devices include external magnetic hard drives, portable flash memory (particularly keydrives) and digital audio players (MP3 players) of format FAT16/32.
- Copyrighted audio files cannot be played back on this receiver.
- With large amounts of data, it may take longer for the receiver to read the contents of a USB device.
- If the file selected cannot be played back, this receiver automatically skips to the next file playable.
- When the file currently being played back has no title assigned to it, the file name is displayed in the OSD instead; when neither the album name nor the artist name is present, the row is displayed as a blank space.
- Note that non-roman characters in the playlist are displayed as '#'.
- Make sure the receiver is in standby when disconnecting the USB device.

1 Switch on the receiver and your TV.

See [Connecting a USB device on page 22](#).

2 Switch the TV input so that it connects to the receiver.

- Switch the TV input to the input that connects this receiver to the TV through the corresponding HDMI cable.

3 Press iPod/USB on the remote control to switch the receiver to the iPod/USB input.

When the display shows the names of folders and files, you're ready to play from the USB device.

If a **USB Error** message lights in the display, try following the points below:

- Switch the receiver off, then on again.
- Reconnect the USB device with the receiver switched off.
- Select another input source (like **BD**), then switch back to **iPod/USB**.
- Use a dedicated AC adapter (supplied with the device) for USB power.

If this doesn't remedy the problem, it is likely your USB device is incompatible.

Playing back audio files stored on a USB memory device

The maximum number of levels that you can select in Step 1 (below) is 9.

- Note that non-Roman characters in the playlist are displayed as '#'.

1 Use ↑/↓ to select a folder, then press ENTER to browse that folder.

- To return to the previous level any time, press **RETURN**.

2 Continue browsing until you arrive at what you want to play, then press ► to start playback.

Basic playback controls

This receiver's remote control buttons can be used for basic playback of files stored on USB devices.

- Press **iPod/USB** to switch the remote control to the iPod/USB operation mode.

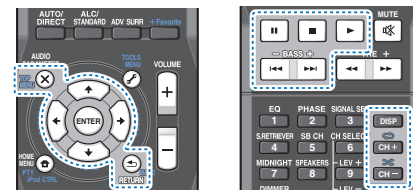

Playing back photo files stored on a USB memory device

1 Use ↑/↓ to select a folder, then press ENTER to browse that folder.

- For high resolution files, some time may be required for the photo to appear.
- To return to the previous level any time, press **RETURN**.

2 Continue browsing until you arrive at what you want to play, then press ► to start playback.

The selected content is displayed in full screen and a slideshow starts.

Basic playback controls

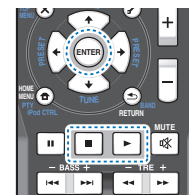

ENTER, ► – Starts displaying a photo and playing a slideshow.

■ – Stops the player and returns to the previous menu.

Tip

- Slideshows of photo files can be played while listening to music files by returning to the folder/file list display while playing a music file on a USB device then playing the photo files.

About playable file formats

The USB function of this receiver supports the following file formats. Note that some file formats are not available for playback although they are listed as playable file formats.

Music files

Extension Stream

MP3 (MPEG-1 Audio Layer 3)

| | | |
|-------------------|----------------------|--------------------------|
| .mp3 ^a | Sampling frequency | 32 kHz, 44.1 kHz, 48 kHz |
| | Quantization bitrate | 16 bit |
| | Channel | 2 ch |
| | Bitrate | 8 kbps to 320 kbps |
| | VBR/CBR | Supported/Supported |

WAV (LPCM)

| | | |
|------|----------------------|--|
| .wav | Sampling frequency | 32 kHz, 44.1 kHz, 48 kHz, 88.2 kHz, 96 kHz, 176.4 kHz, 192 kHz |
| | Quantization bitrate | 16 bit, 24 bit |
| | Channel | 2 ch |

WMA (WMA2/7/8/9)

| | | |
|-------------------|----------------------|--------------------------|
| .wma ^b | Sampling frequency | 32 kHz, 44.1 kHz, 48 kHz |
| | Quantization bitrate | 16 bit |
| | Channel | 2 ch |
| | Bitrate | 5 kbps to 320 kbps |
| | VBR/CBR | Supported/Supported |

AAC (MPEG-4 AAC LC, MPEG-4 HE AAC (aacPlus v1/2))

| | | |
|---|----------------------|--------------------------|
| .m4a ^c .aac .3gp .3g2 | Sampling frequency | 32 kHz, 44.1 kHz, 48 kHz |
| | Quantization bitrate | 16 bit |
| | Channel | 2 ch |
| | Bitrate | 16 kbps to 320 kbps |
| | VBR/CBR | Supported/Supported |

FLAC

| | | |
|--------------------|----------------------|--|
| .flac ^d | Sampling frequency | 32 kHz, 44.1 kHz, 48 kHz, 88.2 kHz, 96 kHz, 176.4 kHz, 192 kHz |
| | Quantization bitrate | 16 bit, 24 bit |
| | Channel | 2 ch |

- MPEG Layer-3 audio decoding technology licensed from Fraunhofer IIS and Thomson multimedia.
- Files encoded using Windows Media Codec 9 may be playable but some parts of the specification are not supported; specifically, Pro, Lossless, Voice.
- Apple lossless encoding is not supported.
- Uncompressed FLAC files are not supported. Pioneer does not guarantee playback.

Photo files

Extension Format

JPEG

| | |
|------|---|
| .jpg | Meeting the following conditions: |
| | <ul style="list-style-type: none"> Baseline JPEG format Y:Cb:Cr - 4:2:2 |

Bluetooth® ADAPTER for Wireless Enjoyment of Music

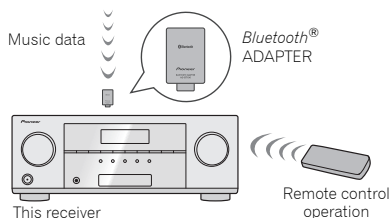
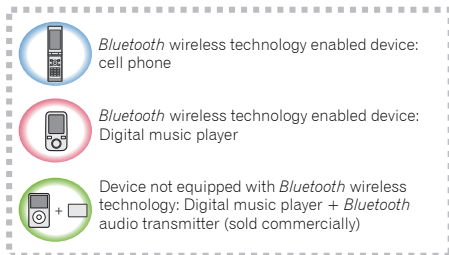

Wireless music play

When the *Bluetooth* ADAPTER (Pioneer Model No. AS-BT100 or AS-BT200) is connected to this unit, a product equipped with *Bluetooth* wireless technology (portable cell phone, digital music player, etc.) can be used to listen to music wirelessly. Also, by using a commercially available transmitter supporting *Bluetooth* wireless technology, you can listen to music on a device not equipped with *Bluetooth* wireless technology. The AS-BT100 and AS-BT200 model supports SCMS-T contents protection, so music can also be enjoyed on devices equipped with SCMS-T type *Bluetooth* wireless technology.

- With the AS-BT100, some functions may not be available on this receiver.

- It must be necessary that the *Bluetooth* wireless technology enabled device supports A2DP profiles.

Important

- Pioneer does not guarantee proper connection and operation of this unit with all *Bluetooth* wireless technology enabled devices.
- About one minute is required between turning the power on and completion of startup.

Remote control operation

The remote control supplied with this unit allows you to play and stop media, and perform other operations.

- It must be necessary that the *Bluetooth* wireless technology enabled device supports AVRCP profiles.
- Remote control operations cannot be guaranteed for all *Bluetooth* wireless technology enabled devices.

Pairing the Bluetooth ADAPTER and Bluetooth wireless technology device

"Pairing" must be done before you start playback of *Bluetooth* wireless technology content using *Bluetooth* ADAPTER. Make sure to perform pairing first time you operate the system or any time pairing data is cleared. "Pairing" is the step necessary to register *Bluetooth* wireless technology device to enable *Bluetooth* communications. For more details, see also the operating instructions of your *Bluetooth* wireless technology device.

- Pairing is required when you first use *Bluetooth* wireless technology device and *Bluetooth* ADAPTER.
- To enable *Bluetooth* communication, pairing should be done with both of your system and *Bluetooth* wireless technology device.
- If the *Bluetooth* wireless technology device's security code is "0000", there is no need to make the security code setting on the receiver. Press **ADAPTER** to switch the **ADAPTER** input, then conduct the pairing operation on the *Bluetooth* wireless technology device. If pairing is successful, there is no need to performing the pairing operation below.
- When using the AS-BT200 only: This unit complies with *Bluetooth* Specifications Ver. 2.1. When this unit and another device equipped with *Bluetooth* wireless technology both comply with *Bluetooth* Specification Ver. 2.1, pairing of the two may be possible without the need for

inputting a password.

In this case, a passcode may be displayed on this receiver and on the device equipped with *Bluetooth* wireless technology. If this happens, check that the same passcode is displayed on this receiver and the device equipped with *Bluetooth* wireless technology, then press **ENTER**. After this, also perform the connection operation on the *Bluetooth* device to be connected. If the passcode does not match the code displayed on the *Bluetooth* device to be connected, press **RETURN** to cancel pairing, then try starting over.

Press **ADAPTER** to set the **ADAPTER** input, then conduct the pairing operation on the *Bluetooth* wireless technology device. If pairing is successful, there is no need to performing the pairing operation below.

- Pair one unit at a time.
- When connecting this receiver by *Bluetooth* connections with a device equipped with the *Bluetooth* function to listen to music, do not connect any devices other than this receiver by *Bluetooth* connection to the *Bluetooth*-equipped device. If a *Bluetooth* connection is already established with a device other than this receiver, disconnect the other device before connecting this receiver.

- 1 Press **ADAPTER** to switch the receiver to **ADAPTER** input.
- 2 Press **TOP MENU** to select Bluetooth Setup.
- 3 Use **↑/↓** to select PIN, then press **ENTER**.
- 4 Use **↑/↓** to select one of PIN codes 0000, 1234 or 8888, then press **ENTER**.
- 5 Switch on the *Bluetooth* wireless technology device that you want to make pairing, place it near the system and set it into the pairing mode.
- 6 Check to see that the *Bluetooth* ADAPTER is detected by the *Bluetooth* wireless technology device.

When *Bluetooth* wireless technology device is connected: *Bluetooth* wireless technology device name appears in the receiver display.

- The system can display alphanumeric characters only. Other characters may not be displayed correctly.

When *Bluetooth* wireless technology device is not connected:

WAITING appears in the receiver display. In this case, perform the connection operation from the side of the *Bluetooth* wireless technology device.

- From the *Bluetooth* wireless technology device list, select **Bluetooth ADAPTER** and enter the PIN code selected in the step 4.

- PIN code may in some case be referred to as **PASSKEY**.

Listening to Music Contents of *Bluetooth* wireless technology device with Your System

- Press **ADAPTER** to switch the receiver to **ADAPTER** input.

The **ADAPTER** input can also be selected by pressing **SOUND RETRIEVER AIR** on the front panel. In this case, **S.R AIR**, the optimum listening mode, is selected automatically.

- Perform the connection operation from the side of the *Bluetooth* wireless technology device to the *Bluetooth* **ADAPTER**.

- When the *Bluetooth* **ADAPTER** is not plugged into the **ADAPTER PORT** terminal, **NO ADP** will be displayed if **ADAPTER** input is selected.

- Start playback of music contents stored in *Bluetooth* wireless technology device.

This receiver's remote control buttons can be used for basic playback of files stored on the *Bluetooth* wireless technology device.

- Bluetooth* wireless technology device should be compatible with **AVRCP** profile.

- Depending on *Bluetooth* wireless technology device you use, operation may differ from what is shown in the remote control buttons.

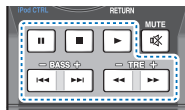

- While listening to a source, press **RECEIVER** then press **ADV SURR** repeatedly to select **S.R AIR**.

AIR JAM

Air Jam – a Pioneer-exclusive application and available for free.

Air Jam lets you connect multi compatible devices to this unit using *Bluetooth* wireless technology. With it, you can make a group playlist directly on a supported device to play in your home theater through the unit. You and your friends can add songs from your devices to the playlist. Also Air Jam lets you delete the song before anyone has to hear it.

- Press **ADAPTER** to switch the receiver to **ADAPTER** input.
- Press **TOP MENU** to select **Bluetooth Setup**.
- Use **↑/↓** to select '**Air Jam**', then press **ENTER**.
- Use **↑/↓** to select '**Air Jam ON**', then press **ENTER**.

For more details on using Air Jam, access our website.
http://pioneer.jp/support/soft/iapp_airjam/en.html

The *Bluetooth*® word mark and logos are registered trademarks owned by Bluetooth SIG, Inc. and any use of such marks by PIONEER CORPORATION is under license. Other trademarks and trade names are those of their respective owners.

Listening to the radio

The following steps show you how to tune in to FM and AM radio broadcasts using the automatic (search) and manual (step) tuning functions. Once you are tuned to a station you can memorize the frequency for recall later—see [Saving station presets below](#) for more on how to do this.

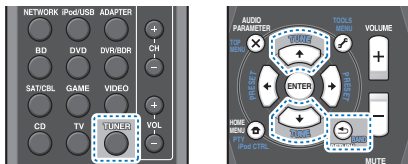

1 Press TUNER to select the tuner.

2 Use BAND to change the band (FM or AM), if necessary.

Each press switches the band between FM (stereo or mono) and AM.

3 Tune to a station.

There are three ways to do this:

❖ Automatic tuning

To search for stations in the currently selected band, press and hold **TUNE** \uparrow/\downarrow for about a second. The receiver will start searching for the next station, stopping when it has found one. Repeat to search for other stations.

❖ Manual tuning

To change the frequency one step at a time, press **TUNE** \uparrow/\downarrow .

❖ High speed tuning

Press and hold **TUNE** \uparrow/\downarrow for high speed tuning. Release the button at the frequency you want.

Improving FM sound

If the **TUNE** or **ST** indicators don't light when tuning to an FM station because the signal is weak, set the receiver to the mono reception mode.

▶ **Press BAND to select FM MONO.**

This should improve the sound quality and allow you to enjoy the broadcast.

Saving station presets

If you often listen to a particular radio station, it's convenient to have the receiver store the frequency for easy recall whenever you want to listen to that station. This saves the effort of manually tuning in each time. This unit can memorize up to 30 stations.

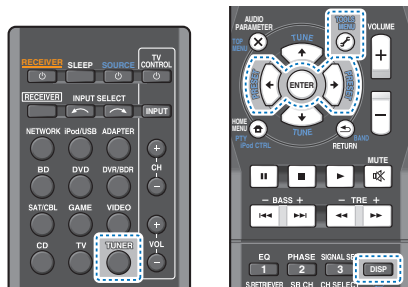

1 Tune to a station you want to memorize.

See [Listening to the radio above](#) for more on this.

2 Press TOOLS.

The display shows **PRESET**, then a blinking **MEM** and station preset.

3 Press PRESET \leftarrow/\rightarrow **to select the station preset you want.**

You can also use the number buttons.

4 Press ENTER.

The preset number stop blinking and the receiver stores the station.

Note

- If the receiver is left disconnected from the AC power outlet for over a month, the station memories will be lost and will have to be reprogrammed.
- Stations are stored in stereo. When the station is stored in the FM MONO mode, it shows as **ST** when recalled.

Listening to station presets

You will need to have some presets stored to do this. See [Saving station presets above](#) if you haven't done this already.

▶ **Press PRESET** \leftarrow/\rightarrow **to select the station preset you want.**

- You can also use the number buttons on the remote control to recall the station preset.

Naming preset stations

For easier identification, you can name all of your preset stations.

1 Choose the station preset you want to name.

See [Listening to station presets above](#) for how to do this.

2 Press TOOLS twice.

The cursor at the first character position is blinking on the display.

3 Input the name you want.

Choose a name up to eight characters long.

- Use **PRESET** \leftarrow/\rightarrow to select character position.
- Use **TUNE** \uparrow/\downarrow to select characters.
- The name is stored when **ENTER** is pressed.

Tip

- To erase a station name, follow steps 1 and 2, and press **ENTER** while the display is blank. Press **TOOLS** while the display is blank, to keep the previous name.
- Once you have named a station preset, Press **DISP** to show the name. When you want to return to the frequency display, press **DISP** several times to show the frequency.

Choosing the listening mode

This receiver offers a variety of listening modes to accommodate playback of various audio formats. Choose one according to your speaker environment or the source.

- While listening to a source, press the listening mode button repeatedly to select a listening mode you want.

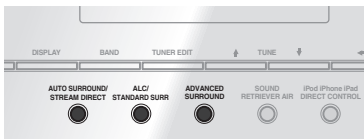
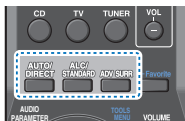

- The listening mode is shown on the display on the front panel.

Important

- The listening modes and many features described in this section may not be available depending on the current source, settings and status of the receiver.

Auto playback



The simplest, most direct listening option is the **AUTO SURROUND** feature. With this, the receiver automatically detects what kind of source you're playing and selects multichannel or stereo playback as necessary.

- Press **AUTO/DIRECT** repeatedly until **AUTO SURROUND** shows briefly in the display (it will then show the decoding or playback format). Check the digital format indicators in the display to see how the source is being processed.

Note

- Stereo surround (matrix) formats are decoded accordingly using **NEO:6 CINEMA** or **DOLBY PLIIx MOVIE** (see [Listening in surround sound below](#) for more on these decoding formats).
- When listening to the **ADAPTER** input, the **S.R AIR** feature is selected automatically (see [Using the Advanced surround on page 34](#) for more on this).

Listening in surround sound



Using this receiver, you can listen to any source in surround sound. However, the options available will depend on your speaker setup and the type of source you're listening to.

- If the source is Dolby Digital, DTS, or Dolby Surround encoded, the proper decoding format will automatically be selected and shows in the display.

When you select **STEREO ALC** (Auto Level Control stereo mode), this unit equalizes playback sound levels if each sound level varies with the music source recorded in a portable audio player.

When you select **STEREO**, you will hear the source through just the front left and right speakers (and possibly your subwoofer depending on your speaker settings). Dolby Digital and DTS multichannel sources are downmixed to stereo.

The following modes provide basic surround sound for stereo and multichannel sources.

Explanatory notes

No: No connected / Yes: Connected / Two: Two speakers are connected / -: Whether connected or no

| Type of surround modes | Suitable sources | Surround back speakers(s) | Front height speakers |
|---------------------------------------|-----------------------|---------------------------|-----------------------|
| Two channel sources | | | |
| STEREO ALC | See above. | – | – |
| DOLBY PLIIx MOVIE | Movie | Yes ^a | No |
| DOLBY PLII MOVIE | | No | – |
| DOLBY PLIIx MUSIC^b | Music | Yes ^a | No |
| DOLBY PLII MUSIC^b | | No | – |
| DOLBY PLIIx GAME | Video games | Yes ^a | No |
| DOLBY PLII GAME | | No | – |
| DOLBY PLIIz HEIGHT^c | Movie/Music | No | Yes |
| NEO:6 CINEMA^d | Movie | – | – |
| NEO:6 MUSIC^d | Music | – | – |
| DOLBY PRO LOGIC | Old movies | – | – |
| Straight Decode ^e | No additional effects | No | – |
| STEREO^f | See above. | – | – |
| Multichannel sources | | | |
| STEREO ALC | See above. | – | – |
| DOLBY PLIIx MOVIE | Movie | Two | No |
| DOLBY PLIIx MUSIC^b | Music | Yes | No |
| DOLBY DIGITAL EX | Movie/Music | Yes | No |
| DTS-ES | Movie/Music | Yes | No |
| DTS NEO:6 | Movie/Music | Yes | No |
| DOLBY PLIIz HEIGHT | Movie/Music | No | Yes |
| Straight Decode ^e | No additional effects | – | – |
| STEREO^f | See above. | – | – |

- a. If surround back channel processing ([page 35](#)) is switched off, or the surround back speakers are set to **NO**, **DOLBY PLIIx** becomes **DOLBY PLII** (5.1 channel sound).

- b. You can also adjust the **C.WIDTH**, **DIMEN.**, and **PNRM** effect (see [Setting the Audio options on page 36](#)).
- c. You can also adjust the **H.GAIN** effect (see [Setting the Audio options on page 36](#)).
- d. You can also adjust the **C.IMG** effect (see [Setting the Audio options on page 36](#)).
- e.
 - In case of **VSX-1022**: Cannot be selected when the **Speaker System** is set to **Surr. Back** (see [The Speaker System setting \(VSX-1022 only\) on page 49](#)).
 - In case of **VSX-822**: Cannot be selected when the **Pre Out** is set to **Surr. Back** (see [The Pre Out Setting \(VSX-822 only\) on page 50](#)).
- f. The audio is heard with your surround settings and you can still use the **Midnight**, **Loudness**, **Phase Control**, **Sound Retriever** and **Tone** functions.

Note

- In modes that give 6.1 channel sound, the same signal is heard from both surround back speakers.

Using the Advanced surround



The Advanced surround feature creates a variety of surround effects. Try different modes with various soundtracks to see which you like.

| | |
|----------------------|---|
| ACTION | Designed for action movies with dynamic soundtracks. |
| DRAMA | Designed for movies with lots of dialog. |
| ENT.SHOW | Suitable for musical sources. |
| ADVANCED GAME | Suitable for video games. |
| SPORTS | Suitable for sports programs. |
| CLASSICAL | Gives a large concert hall-type sound |
| ROCK/POP | Creates a live concert sound for rock and/or pop music. |
| UNPLUGGED | Suitable for acoustic music sources. |
| EXT.STEREO | Gives multichannel sound to a stereo source, using all of your speakers |

F.S.S.ADVANCE (Front Stage Surround ADVANCE)

Allows you to create natural surround sound effects using just the front speakers and the subwoofer.

Use to provide a rich surround sound effect directed to the center of where the front left and right speakers sound projection area converges.

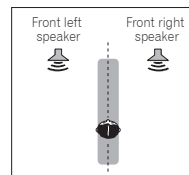

S.R AIR (Sound Retriever AIR)

Suitable for listening to the sound from a **Bluetooth** wireless technology device. The **S.R AIR** listening mode can only be selected when the **ADAPTER** input.

PHONES SURR

When listening through headphones, you can still get the effect of overall surround

Using Stream Direct



Use the Stream Direct modes when you want to hear the truest possible reproduction of a source. All unnecessary signal processing is bypassed.

AUTO SURROUND See [Auto playback on page 33](#).

DIRECT

Sources are heard according to the settings made in the Manual SP Setup (speaker setting, channel level, speaker distance), as well as with dual mono settings. You will hear sources according to the number of channels in the signal.

Phase Control, Acoustic Calibration EQ, Sound Delay, Auto Delay, LFE Attenuate and Center image functions are available.

PURE DIRECT

Analog and PCM sources are heard without any digital processing.

Using the Sound Retriever

When audio data is removed during the compression process, sound quality often suffers from an uneven sound image. The Sound Retriever feature employs new DSP technology that helps bring CD quality sound back to compressed 2-channel audio by restoring sound pressure and smoothing jagged artifacts left over after compression.

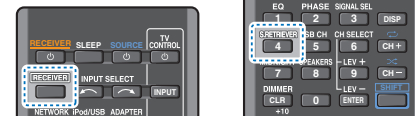

▶ Press **RECEIVER**, then press **S.RETRIEVER** to switch the **S.RTV (Sound Retriever) ON or OFF**.

Note

- The Sound Retriever is only applicable to 2-channel sources.

Listening with Acoustic Calibration EQ

You can listen to sources using the Acoustic Calibration Equalization set in [Automatically setting up for surround sound \(MCACC\) on page 23](#). Refer to these pages for more on Acoustic Calibration Equalization.

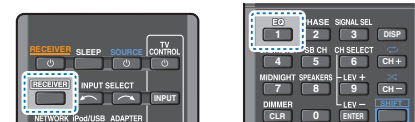

▶ While listening to a source, press **RECEIVER**, then press **EQ** to switch the EQ (Acoustic Calibration EQ) ON or OFF.

The MCACC indicator on the front panel lights when Acoustic Calibration EQ is active.

- You can't use Acoustic Calibration EQ with Stream Direct mode and it has no effect with headphones.

Better sound using Phase Control

This receiver's Phase Control feature uses phase correction measures to make sure your sound source arrives at the listening position in phase, preventing unwanted distortion and/or coloring of the sound.

Phase Control technology provides coherent sound reproduction through the use of phase matching for an optimal sound image at your listening position. The default setting is on and we recommend leaving Phase Control switched on for all sound sources.



While listening to a source, press **RECEIVER**, then press **PHASE** to switch the P.CTL (Phase Control) ON or OFF.

Note

- Phase matching is a very important factor in achieving proper sound reproduction. If two waveforms are 'in phase', they crest and trough together, resulting in increased amplitude, clarity and presence of the sound signal. If a crest of a wave meets a trough, then the sound will be 'out of phase' and an unreliable sound image will be produced.
- If your subwoofer has a phase control switch, set it to the plus (+) sign (or 0°). However, the effect you can actually feel when Phase Control is set to **ON** on this receiver depends on the type of your subwoofer. Set your subwoofer to maximize the effect. It is also recommended you try changing the orientation or the place of your subwoofer.
- Set the built-in lowpass filter switch of your subwoofer to OFF. If this cannot be done on your subwoofer, set the cutoff frequency to a higher value.
- If the speaker distance is not properly set, you may not have a maximized Phase Control effect.
- The Phase Control mode cannot be set to **ON** in the following cases:
 - When the **PURE DIRECT** mode is switched on.
 - When the headphones are connected.

Using surround back channel processing

You can have the receiver automatically use 6.1 or 7.1 decoding for 6.1 encoded sources (for example, Dolby Digital EX or DTS-ES), or you can choose to always use 6.1 or 7.1 decoding (for example, with 5.1 encoded material). With 5.1 encoded sources, a surround back channel will be generated, but the material may sound better in the 5.1 format for which it was originally encoded (in which case, you can simply switch surround back channel processing off).

- With a 7.1-channel surround system, audio signals that have undergone matrix decoding processing through surround back channel processing to which the Up Mix function is added are output from the surround back speakers.



Press **RECEIVER**, then press **SB CH** repeatedly to cycle the surround back channel options.

Each press cycles through the options as follows:

- SB ON** – Matrix decoding processing for generating the surround back component from the surround component is turned on.
- SB AUTO** – Matrix decoding processing for generating the surround back component from the surround component is switched automatically. Matrix decoding processing is only performed when surround back channel signals are detected in the input signals.
- SB OFF** – Matrix decoding processing for generating the surround back component from the surround component is turned off.

Setting the Up Mix function

In a 7.1-channel surround system with surround speakers placed directly at the sides of the listening position, the surround sound of 5.1-channel sources is heard from the side. The Up Mix function mixes the sound of the surround speakers with the surround back speakers so that the surround sound is heard from diagonally to the rear as it should be.

- Using the Up Mix function is effective when the speakers in the 7.1-channel surround system are set up as recommended in the example on [page 11](#).
- Depending on the positions of the speakers and the sound source, in some cases it may not be possible to achieve good results. In this case, set the setting to **OFF**.

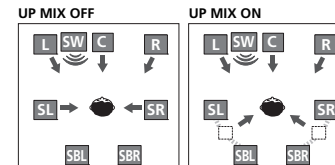

1 Switch the receiver into standby.

2 While holding down **PRESET** → on the front panel, and hold the **STANDBY/ON** for about two seconds.

UP MIX: OFF appears and the Up Mix function turns off. If you want to turn this function on, perform steps 1 and 2 again.

- When set to **ON**, the  (Up Mix) indicator on the front panel lights.

Note

- Set to **ON** regardless of this setting when playing DTS-HD signals.
- May automatically be set to **OFF** even when set to **ON**, depending on the input signal and listening mode.
- If the **Network Standby** is set to **ON** or **Standby Through** is not set to **OFF**, you may not be able to set the Up Mix function.

Setting the Audio options

There are a number of additional sound settings you can make using the **AUDIO PARAMETER** menu. The defaults, if not stated, are listed in bold.

Important

- Note that if a setting doesn't appear in the **AUDIO PARAMETER** menu, it is unavailable due to the current source, settings and status of the receiver.

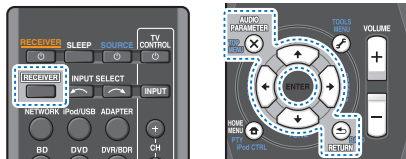

- Press **RECEIVER**, then press **AUDIO PARAMETER**.
- Use **↑/↓** to select the setting you want to adjust. Depending on the current status/mode of the receiver, certain options may not be able to be selected. Check the table below for notes on this.
- Use **←/→** to set it as necessary. See the table below for the options available for each setting.
- Press **RETURN** to confirm and exit the menu.

| Setting/What it does | Option(s) |
|---|--|
| EQ (Acoustic Calibration EQ) Switches on/off the effect of Acoustic Calibration EQ. | ON <i>OFF</i> |
| S.DELAY (Sound Delay) Some monitors have a slight delay when showing video, so the soundtrack will be slightly out of sync with the picture. By adding a bit of delay, you can adjust the sound to match the presentation of the video. | 0.0 to 9.0 (frames) <i>1 second = 30 frames (NTSC)</i> Default: 0.0 |
| MIDNIGHT/LOUDNESS ^a The MIDNIGHT allows you to hear effective surround sound of movies at low volumes. The LOUDNESS is used to get good bass and treble from music sources at low volumes. | M/L OFF <i>MIDNIGHT</i> <i>LOUDNESS</i> |
| S.RTV (Sound Retriever) ^b When audio data is removed during the compression process, sound quality often suffers from an uneven sound image. The Sound Retriever feature employs new DSP technology that helps bring CD quality sound back to compressed 2-channel audio by restoring sound pressure and smoothing jagged artifacts left over after compression. | OFF ^c <i>ON</i> |
| DUAL MONO ^d Specifies how dual mono encoded Dolby Digital soundtracks should be played. | CH1 – Channel 1 is heard only <i>CH2</i> – Channel 2 is heard only <i>CH1 CH2</i> – Both channels heard from front speakers |
| F.PCM (Fixed PCM) This is useful if you find there is a slight delay before OFF recognizes the PCM signal on a CD, for instance. When ON is selected, noise may be output during playback of non-PCM sources. Please select another input signal if this is a problem. | OFF <i>ON</i> |

| Setting/What it does | Option(s) |
|---|--|
| DRC (Dynamic Range Control) Adjusts the level of dynamic range for movie soundtracks optimized for Dolby Digital, DTS, Dolby Digital Plus, Dolby TrueHD, DTS-HD and DTS-HD Master Audio (you may need to use this feature when listening to surround sound at low volumes). | AUTO ^e <i>MAX</i> <i>MID</i> <i>OFF</i> |
| LFE ATT (LFE Attenuate) Some Dolby Digital and DTS audio sources include ultra-low bass tones. Set the LFE attenuator as necessary to prevent the ultra-low bass tones from distorting the sound from the speakers. The LFE is not limited when set to 0 dB, which is the recommended value. When set to –15 dB, the LFE is limited by the respective degree. When OFF is selected, no sound is output from the LFE channel. | 0 (0 dB) <i>5</i> (–5 dB) <i>10</i> (–10 dB) <i>15</i> (–15 dB) <i>20</i> (–20 dB) ** (OFF) |
| SACD G. (SACD Gain) ^f Brings out detail in SACDs by maximizing the dynamic range (during digital processing). | 0 (0 dB) <i>+6</i> (+6 dB) |
| HDMI (HDMI Audio) Specifies the routing of the HDMI audio signal out of this receiver (AMP) or through to a TV (THRU). When THRU is selected, no sound is output from this receiver. | AMP <i>THRU</i> |
| A.DLY (Auto Delay) ^g This feature automatically corrects the audio-to-video delay between components connected with an HDMI cable. The audio delay time is set depending on the operational status of the display connected with an HDMI cable. The video delay time is automatically adjusted according to the audio delay time. | OFF <i>ON</i> |
| C.WIDTH (Center Width) ^h (Applicable only when using a center speaker) Spreads the center channel between the front right and left speakers, making it sound wider (higher settings) or narrower (lower settings). | 0 to 7 Default: 3 |

| Setting/What it does | Option(s) |
|---|--|
| DIMEN (Dimension) ^h Adjusts the surround sound balance from front to back, making the sound more distant (minus settings), or more forward (positive settings). | -3 to +3 Default: 0 |
| PNRM (Panorama) ^h Extends the front stereo image to include surround speakers for a 'wraparound' effect. | OFF <i>ON</i> |
| C.IMG (Center Image) ⁱ (Applicable only when using a center speaker) Adjust the center image to create a wider stereo effect with vocals. Adjust the effect from 0 (all center channel sent to front right and left speakers) to 10 (center channel sent to the center speaker only). | 0 to 10 Default: 3 (NEO:6 MUSIC), 10 (NEO:6 CINEMA) |
| H.GAIN (Height Gain) Adjusts the output from the front height speaker when listening in DOLBY PLIIz HEIGHT mode. If set to H , the sound from the top will be more emphasized. | <i>L (Low)</i> M (Mid) <i>H (High)</i> |

- a. You can change the MIDNIGHT/LOUDNESS options at any time by using **MIDNIGHT** button.
 - b. You can change the Sound Retriever feature at any time by using **S.RETRIEVER** button.
 - c. The default setting when the **iPod/USB. ADAPTER**, **NETRADIO**, **PANDORA**, **M.SERVER** or **FAVORITE** input is selected is **ON**.
 - d. This setting works only with dual mono encoded Dolby Digital and DTS soundtracks.
 - e. The initial set **AUTO** is only available for Dolby TrueHD signals. Select **MAX** or **MID** for signals other than Dolby TrueHD.
 - f. You shouldn't have any problems using this with most SACD discs, but if the sound distorts, it is best to switch the gain setting back to **0** dB.
 - g. This feature is only available when the connected display supports the automatic audio/video synchronizing capability ("lip-sync") for HDMI. If you find the automatically set delay time unsuitable, set **A.DLY** to **OFF** and adjust the delay time manually. For more details about the lip-sync feature of your display, contact the manufacturer directly.
 - h. Only available with 2-channel sources in **DOLBY PLII MUSIC** mode.
- i. Only when listening to 2-channel sources in **NEO:6 CINEMA** and **NEO:6 MUSIC** mode.



Introduction

This receiver is equipped with the LAN terminal and you can enjoy the following features by connecting your components to these terminals.

Listening to Internet radio stations

You can select and listen to your favorite Internet radio station from the list of Internet radio stations created, edited, and managed by the vTuner database service exclusively for use with the Pioneer products.

See [Playback with Network functions on page 39](#) and [Listening to Internet radio stations on page 39](#).

Playback the music files stored in PCs

You can playback a lot of musics stored in your PCs using this unit.

- Besides a PC, you can also play back audio files stored on your other components with the built-in media server function based on DLNA 1.0 or DLNA 1.5 framework and protocols (i.e. network-capable hard disks and audio systems).

See [Playback with Network functions on page 39](#) and [Playing back audio files stored on components on the network on page 40](#).

Listening to Pandora

See [Listening to Pandora Internet Radio on page 40](#).

Note

- To listen to Internet radio stations, you must sign a contract with an ISP (Internet Service Provider) beforehand.
- Photo or video files cannot be played back.
- With Windows Media Player 11 or Windows Media Player 12, you can even play back copyrighted audio files on this receiver.

About playable DLNA network devices

This unit allows you to play music on media servers connected on an identical Local Area Network (LAN) as the receiver. This unit allows for the playing of files stored on the following devices:

- PCs running Microsoft Windows Vista or XP with Windows Media Player 11 installed
- PCs running Microsoft Windows 7 with Windows Media Player 12 installed
- DLNA-compatible digital media servers (on PCs or other components)

Files stored in a PC or DMS (Digital Media Server) as described above can be played via command from an external Digital Media Controller (DMC). Devices controlled by this DMC to play files are called DMRs (Digital Media Renderers). This receiver supports this DMR function. When in the DMR mode, such operations as playing and stopping files can be performed from the external controller. Volume adjustment and the muting control are also possible.

- Depending on the external controller being used, playback may be interrupted when the volume is adjusted from the controller. In this case, adjust the volume from the receiver or remote control.

Using AirPlay on iPod touch, iPhone, iPad, and iTunes

AirPlay works with iPhone 4S, iPhone 4, iPhone 3GS, iPod touch (4th, 3rd and 2nd generations), iPad 2, iPad with iOS 4.2 or later, and iTunes 10.1 (Mac and PC) or later.

To use AirPlay, select your receiver on your iPod touch, iPhone, iPad or in iTunes. *1

The receiver's input will switch automatically to AirPlay when AirPlay is in use. *2

The following operations can be performed when in AirPlay mode:

- Adjustment of the receiver's volume from iPod touch, iPhone, iPad or iTunes.

- Pause/resume, next/previous track, and shuffle/repeat from the remote control of the receiver. (Press **NETWORK** to switch the remote control to the network operation mode.)

*1: For more information, see the Apple website (<http://www.apple.com>).

*2: The receiver's power automatically turns on when **Network Standby** is set to **ON** ([page 51](#)).

Note

- A network environment is required to use AirPlay.
- AirPlay provided on this receiver has been developed and tested based on the software versions for the iPod, iPhone, iPad and the software versions for iTunes that are indicated on the Pioneer website. AirPlay may not be compatible with iPod, iPhone, iPad or iTunes software versions other than those indicated on the Pioneer website.

About the DHCP server function

To play back audio files stored on components on the network or listen to Internet radio stations, you must turn on the DHCP server function of your router. In case your router does not have the built-in DHCP server function, it is necessary to set up the network manually. Otherwise, you cannot play back audio files stored on components on the network or listen to Internet radio stations. See [The Network Setup menu on page 41](#) for more on this.

Authorizing this receiver

This receiver must be authorized to enable playback. This happens automatically when the receiver makes a connection over the network to the PC. If not, please authorize this receiver manually on the PC. The authorization (or permission) method for access varies depending on the type of server currently being connected. For more information on authorizing this receiver, refer to the instruction manual of your server.

Playback with Network functions

Important

- In case a domain is configured in a Windows network environment, you cannot access a PC on the network while you are logged onto the domain. Instead of logging onto the domain, log onto the local machine.
- There are cases where the time elapsed may not be correctly displayed.
- About one minute is required between turning the power on and completion of startup.

1 Press NETWORK repeatedly to select the category you want to play back.

It may take several seconds for this receiver to access the network.

Select a category from the following list:

- NETRADIO** – Internet radio
- PANDORA** – Internet radio that supports Pandora
- M.SERVER** – Server components on the network (Media server)
- FAVORITE** – Favorite songs currently being registered

Depending on the selected category, the names of folders, files, and Internet radio stations are displayed.

2 Use \uparrow/\downarrow to select the folder, music files or Internet radio station to play back, and then press ENTER.

Press \uparrow/\downarrow to scroll up and down the list and select the desired item. When you press **ENTER**, playback starts with the playback screen being displayed for the selected item. To return to the list screen, press **RETURN**.

When the list screen is displayed from the playback screen, the playback screen reappears automatically if no operation is performed for 10 seconds while the list screen is displayed.

Only audio files with the  mark can be played. In case of the folders with the  mark, use \uparrow/\downarrow and **ENTER** to select the desired folder and audio files.

3 Repeat step 2 to play back the desired song.

For detailed operating instructions, refer to the section shown below.

- Internet radio stations – See [Listening to Internet radio stations below](#).
- Pandora – See [Listening to Pandora Internet Radio on page 40](#).
- Media server – See [Playing back audio files stored on components on the network on page 40](#).
- Favorites – See [Playing back your favorite songs on page 40](#).

Basic playback controls

You can perform the following operations with the remote control of this receiver. Note that some buttons are not available for operation depending on the category currently being played back.

▶ Press NETWORK to switch the remote control to the NETRADIO, PANDORA, M.SERVER or FAVORITE operation mode.

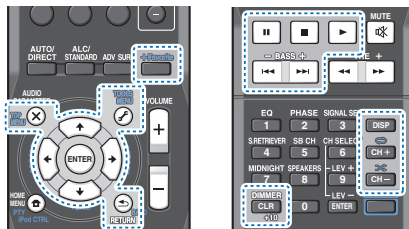

Listening to Internet radio stations

Internet radio is an audio broadcasting service transmitted via the Internet. There are a large number of Internet radio stations broadcasting a variety of services from every corner of the world. Some are hosted, managed, and broadcast by private individuals while others are by the corresponding traditional terrestrial radio stations or radio networks. Whereas terrestrial, or OTA (over-the-air), radio stations are geographically restricted on the range of radio waves broadcast from a transmitter through the air, Internet radio stations are accessible from anywhere in the world, as long as there is a connection to the Internet, as services are not transmitted through the air but are delivered over the World Wide Web. On this receiver you can select Internet radio stations by genre as well as by region.

Depending on the Internet line conditions, the sound may not be smooth when playing Internet radio.

About list of Internet radio

The list of Internet radio stations on this receiver is created, edited, and managed by the vTuner database service exclusively for use with this receiver. For details about vTuner, see [vTuner on page 44](#).

Saving and retrieving Internet radio stations

You can easily save and retrieve saved Internet radio stations. See [Playing back your favorite songs on page 40](#) for more on this.

- To listen to Internet radio stations, you must have high-speed broadband Internet access. With a 56 K or ISDN modem, you may not enjoy the full benefits of Internet radio.
- The port number varies depending on the Internet radio station. Check the firewall settings.
- A list of Internet radio stations provided by the vTuner database service is subject to change or deletion without notice due to various reasons.
- Broadcasts may be stopped or interrupted depending on the Internet radio station. In this case, you cannot listen to a radio station selected from the list of Internet radio stations.

Registering broadcast stations not on the vTuner list from the special Pioneer site

With the receiver, broadcast stations not included on the list of station distributed by vTuner can be registered and played. Check the access code required for registration on the receiver, use this access code to access the special Pioneer Internet radio site and register the desired broadcast stations in your favorites. The address of the special Pioneer Internet radio site is:

<http://www.radio-pioneer.com>

1 Display the Internet Radio list screen.

To display the Internet Radio list screen, perform step 1 at [Playback with Network functions on page 39](#).

2 Use \uparrow/\downarrow to select 'Help', then press ENTER.

3 Use \uparrow/\downarrow to select 'Get access code', then press ENTER.

The access code required for registration on the special Pioneer Internet radio site is displayed. Make a memo of this address.

The following can be checked on the **Help** screen:

- **Get access code** – The access code required for registration on the special Pioneer Internet radio site is displayed.
- **Show Your WebID/PW** – After registering on the special Pioneer Internet radio site, the registered ID and password are displayed.
- **Reset Your WebID/PW** – Resets all the information registered on the special Pioneer Internet radio site. When reset, all the registered broadcast stations are also cleared. If you want to listen to the same stations, re-register after resetting.

4 Access the special Pioneer Internet radio site from your computer and perform the registration process.

<http://www.radio-pioneer.com>

Access the above site and use the access code in step 3 to perform user registration, following the instructions on the screen.

5 Register the desired broadcast stations as your favorites, following the instructions on the computer's screen.

Both broadcast stations not on the vTuner list and stations on the vTuner list can be registered. In this case they are registered on the receiver as favorite broadcast stations and can be played.

Listening to Pandora Internet Radio

Pandora is personalized internet radio that is designed to help you discover new music you'll love mixed in with music you already know.

For details, check the website: <http://www.pandora.com>

- You must have a registered account in order to listen to songs using Pandora Internet Radio. Select **PANDORA**, then follow the instructions on the screen to make the account settings.
- As of April 2011, the Pandora service is only offered in the United States.
- Some functions may be changed at Pandora's discretion.

Note

- When disposing of the product, we recommend you reset it to delete the data. See [Resetting the main unit on page 63](#).

Pandora®, the leading internet radio service, gives people music they love anytime, anywhere, through personalized radio stations.

Playing back audio files stored on components on the network

This unit allows you to play music on media servers connected on an identical Local Area Network (LAN) as the receiver. This unit allows for the playing of files stored on the following devices:

- PCs running Microsoft Windows Vista or XP with Windows Media Player 11 installed
- PCs running Microsoft Windows 7 with Windows Media Player 12 installed
- DLNA-compatible digital media servers (on PCs or other components)

Playing back your favorite songs

Up to 64 favorite tracks on the media server and/or Internet radio stations can be registered in the Favorites folder. Note that only the audio files stored on components on the network can be registered.

Registering and deleting audio files and Internet radio stations in and from the Favorites folder

1 Press NETWORK to switch the remote control to the M.SERVER or NETRADIO operation mode.

2 With the track or Internet radio station you want to register selected, press +Favorite.

The selected song or Internet radio station is then registered in the Favorite.

Note

- To delete a registered song, select the Favorites folder, select the song you want to delete from the folder, and press **CLEAR**. The selected song is then deleted from the Favorites folder.

The Network Setup menu

Setting up the network to listen to Internet radio on this receiver.

- 1 **Press NETWORK repeatedly to switch the receiver to NETRADIO input.**
- 2 **Press HOME MENU.**
Network Setup menu appears on your TV. Use **↑/↓/←/→** and **ENTER** on the remote control to navigate through the screens and select menu items. Press **RETURN** to exit the current menu.
 - Press **HOME MENU** at any time to exit the Network Setup menu.
- 3 **Select the setting you want to adjust.**
 - **Network Configuration**
 - **IP Address, Proxy** – Sets up the IP address/Proxy of this receiver (see below).
 - **Friendly Name** – The name of the receiver displayed on a computer or other device connected to the network can be changed (see below).
 - **Parental Lock** – Restricts usage of network functions ([page 42](#)).
 - **Language** – Language can be set the NETWORK function OSD screen ([page 42](#)).
 - **Firmware Update** – Use to update the receiver's software and check the version ([page 42](#)).
 - **Factory Reset** – Use to reset all network connection settings to their initial, factory-setting condition ([page 42](#)).
 - **System Info** – You can check the network settings of this receiver ([page 42](#)).

Network Configuration

IP address/Proxy setting

In case the router connected to the LAN terminal on this receiver is a broadband router (with a built-in DHCP server function), simply turn on the DHCP server function, and you will not need to set up the network manually. You must set up the network as described below only when you have connected this receiver to a broadband router without a

DHCP server function. Before you set up the network, consult with your ISP or the network manager for the required settings. It is advised that you also refer to the operation manual supplied with your network component.

- **IP Address**
The IP address to be entered must be defined within the following ranges. If the IP address defined is beyond the following ranges, you cannot play back audio files stored on components on the network or listen to Internet radio stations.
Class A: 10.0.0.1 to 10.255.255.254
Class B: 172.16.0.1 to 172.31.255.254
Class C: 192.168.0.1 to 192.168.255.254
- **Subnet Mask**
In case an xDSL modem or a terminal adapter is directly connected to this receiver, enter the subnet mask provided by your ISP on paper. In most cases, enter 255.255.255.0.
- **Default Gateway**
In case a gateway (router) is connected to this receiver, enter the corresponding IP address.
- **Primary DNS Server/Secondary DNS Server**
In case there is only one DNS server address provided by your ISP on paper, enter it in the "**Primary DNS Server**" field. In case there are more than two DNS server addresses, enter "**Secondary DNS Server**" in the other DNS server address field.
- **Proxy Hostname/Proxy Port**
This setting is required when you connect this receiver to the Internet via a proxy server. Enter the IP address of your proxy server in the "**Proxy Hostname**" field. Also, enter the port number of your proxy server in the "**Proxy Port**" field.

- 1 **Select 'Network Configuration' from the Network Setup menu.**
- 2 **Select 'IP Address, Proxy' from the Network Configuration menu.**
- 3 **Select the DHCP setting you want.**
When you select **ON**, the network is automatically set up, and you do not need to follow Steps 4. Proceed with Step 5.

If there is no DHCP server on the network and you select **ON**, this receiver will use its own Auto IP function to determine the IP address.

- The IP address determined by the Auto IP function is 169.254.X.X. You cannot listen to an Internet radio station if the IP address is set for the Auto IP function.

- 4 **Enter the IP Address, Subnet Mask, Default Gateway, Primary DNS Server and Secondary DNS Server.**
Press **↑/↓** to select a number and **←/→** to move the cursor.
- 5 **Select 'OFF' or 'ON' for the Enable Proxy Server setting to deactivate or activate the proxy server.**
In case you select **OFF**, proceed with Step 8. In case you select **ON**, on the other hand, proceed with Step 6.
- 6 **Enter the address of your proxy server or the domain name.**
Use **↑/↓** to select a character, **←/→** to set the position, and **ENTER** to confirm your selection.
- 7 **Enter the port number of your proxy server.**
Use **↑/↓** to select a character, **←/→** to set the position, and **ENTER** to confirm your selection.
- 8 **Select 'OK' to confirm the IP Address/Proxy setup.**

Friendly Name

- 1 **Select 'Network Configuration' from the Network Setup menu.**
- 2 **Select 'Friendly Name' from the Network Configuration menu.**
- 3 **Select 'Edit Name' then select 'Rename'.**
If after changing the name you want to restore the name to the default, select **Default**.
- 4 **Input the name you want.**
Use **↑/↓** to select a character, **←/→** to set the position, and **ENTER** to confirm your selection.

Parental Lock

Set restrictions for using Internet services. Also set the password accompanying the usage restrictions.

- Upon shipment from the factory, the password is set to "0000".

- 1 **Select 'Network Configuration' from the Network Setup menu.**
- 2 **Select 'Parental Lock' from the Network Configuration menu.**
- 3 **Input the password.**
Use \uparrow/\downarrow to select a character, \leftarrow/\rightarrow to set the position, and **ENTER** to confirm your selection.
- 4 **Specify whether to turn Parental Lock on or off.**
 - **OFF** – Internet services are not restricted.
 - **ON** – Internet services are restricted.
- 5 **If you want to change the password, select 'Change Password'.**
In this case, the procedure returns to step 3.

Language

Language can be set on the NETWORK function OSD screen.

- 1 **Select 'Language' from the Network Setup menu.**
- 2 **Select the language you want.**
- 3 **When you're finished, press RETURN.**
You return to the Network Setup menu.

Firmware Update

Use this procedure to update the receiver's software. Updating via a USB memory device is performed by downloading the update file from a computer, reading this file onto a USB memory device then inserting this USB memory device into the USB port on the receiver's front panel. With this procedure, the USB memory device containing the update file must first be inserted into the USB port on the receiver's front panel.

- If an update file is provided on the Pioneer website, download it onto your computer. When downloading an update file from the Pioneer website onto your computer, the file will be in ZIP format. Unzip the ZIP file before saving it on the USB memory device. If there are any old downloaded files or downloaded files for other models on the USB memory device, delete them.

Important

- DO NOT unplug the power cord during updating.
- Do not disconnect the USB memory device during updating.
- Verify the software version of the receiver in the **System Info** menu before updating and confirm that the software in the USB memory device is a newer version.
- Updating may reset the receiver's settings to the initial, factory-setting condition. Whether this is applicable to your receiver can be confirmed at our Pioneer website.

- 1 **Select 'Firmware Update' from the Network Setup menu.**
The receiver checks whether the USB memory device inserted into the USB port on the receiver's front panel contains updatable software.

- 2 **To update, select 'Start'.**

- 3 **When 'Updating in progress, don't unplug!' is displayed, select 'OK'.**
 - If **'File Not Found'** is displayed, try the following:
 - No update file was found on the USB memory device. Store the file in the USB memory device's root directory.
 - Try disconnecting then reconnecting the USB device or storing the update file again. If the error still occurs, try using a different USB memory device.

- 4 **The software update will start. Please wait.**
The OSD display will turn off during update and the words **'UPDATE'** will flash on the front panel.

- 5 **If 'COMPLETE' is displayed, updating is completed.**
The screen will return automatically to the play screen.
 - If **'FAIL'** is displayed on the front panel display, updating has failed. Try the following:
 - Turn the receiver's power off, then turn it back on and try updating the software again.
 - Try disconnecting then reconnecting the USB device or storing the update file again. If the error still occurs, try using a different USB memory device.

Factory Reset

Use to reset all network connection settings to their initial, factory-setting condition.

- 1 **Select 'Factory Reset' from the Network Setup menu.**
- 2 **Select 'Start'.**
- 3 **Select 'OK' to confirm.**
The screen will return automatically to the play screen.

System Information

The setting status of the following network-related items can be checked.

- IP Address – Check the IP address of this receiver.
- MAC Address – Check the MAC address of this receiver.
- Release ID – Check the software version of this receiver.

- 1 **Select 'System Info' from the Network Setup menu.**
Display the setting status of the network-related items.
- 2 **When you're finished, press RETURN.**
You return to the Network Setup menu.

About network playback

The network playback function of this unit uses the following technologies:

Windows Media Player

See [Windows Media Player 11/Windows Media Player 12 on page 44](#) for more on this.

Windows Media DRM

Microsoft Windows Media Digital Rights Management (WMDRM) is a platform to protect and securely deliver content for playback on computers, portable devices and network devices. This unit's functions as a WMDRM 10 for networked devices. WMDRM protected content can only be played on media servers supporting WMDRM.

Content owners use WMDRM technology to protect their intellectual property, including copyrights. This device uses WMDRM software to access WMDRM protected content. If the WMDRM software fails to protect the content, content owners may ask Microsoft to revoke the software's ability to use WMDRM to play or copy protected content. Revocation does not affect unprotected content. When you download licenses for protected content, you agree that Microsoft may include a revocation list with the licenses. Content owners may require you to upgrade WMDRM to access their content. If you decline an upgrade, you will not be able to access content that requires the upgrade.

This product is protected by certain intellectual property rights of Microsoft. Use or distribution of such technology outside of this product is prohibited without a license from Microsoft.

DLNA



DLNA CERTIFIED™ Audio Player

The Digital Living Network Alliance (DLNA) is a cross-industry organization of consumer electronics, computing industry and mobile device companies. Digital Living provides consumers with easy sharing of digital media through a wired or wireless network in the home.

The DLNA certification logo makes it easy to find products that comply with the DLNA Interoperability Guidelines. This unit complies with DLNA Interoperability Guidelines v1.5. When a PC running DLNA server software or other DLNA compatible device is connected to this player, some setting changes of software or other devices may be required. Please refer to the operating instructions for the software or device for more information.

DLNA™, the DLNA Logo and DLNA CERTIFIED™ are trademarks, service marks, or certification marks of the Digital Living Network Alliance.

Content playable over a network

- Even when encoded in a compatible format, some files may not play correctly.
- Movie or Photo files cannot be played back.
- There are cases where you cannot listen to an Internet radio station even if the station can be selected from a list of radio stations.
- Some functions may not be supported depending on the server type or version used.
- Supported file formats vary by server. As such, files not supported by your server are not displayed on this unit. For more information check with the manufacturer of your server.

Disclaimer for Third Party Content

ACCESS TO THIRD PARTY CONTENT SERVICES, INCLUDING ALL ASSOCIATED FEATURES AND FUNCTIONALITIES, IS PROVIDED "AS IS," "AS AVAILABLE" AND AT THE USER'S OWN RISK. WITHOUT WARRANTY OF ANY KIND, PIONEER DISCLAIMS ALL WARRANTIES, EXPRESS OR IMPLIED, IN CONNECTION WITH ACCESS TO AND USE OF CONTENT SERVICES THROUGH THIS DEVICE, INCLUDING WITHOUT LIMITATION WARRANTIES OF MERCHANTABILITY, SATISFACTORY QUALITY, FITNESS FOR A PARTICULAR PURPOSE, AND NON-INFRINGEMENT. PIONEER DOES NOT GUARANTEE, REPRESENT, OR WARRANT THAT CONTENT SERVICES WILL BE FREE FROM ERRORS, INTERRUPTION, LOSS, CORRUPTION, ATTACK, VIRUSES, INTERFERENCE, HACKING, OR OTHER SECURITY INTRUSION, AND PIONEER DISCLAIMS ANY LIABILITY IN CONNECTION WITH THE FOREGOING. PIONEER IS NOT LIABLE OR RESPONSIBLE FOR ANY LOSS OR DAMAGE ARISING FROM ACCESS TO OR USE OF CONTENT. NO ORAL OR WRITTEN INFORMATION OR ADVICE GIVEN BY PIONEER OR ITS CUSTOMER SERVICES REPRESENTATIVES WILL CREATE ANY SUCH WARRANTY.

IN NO EVENT WILL PIONEER, ITS AFFILIATES, OR THEIR RESPECTIVE OFFICERS, DIRECTORS, OR EMPLOYEES BE LIABLE IN CONNECTION WITH YOUR USE OF THIRD PARTY CONTENT SERVICES THROUGH THIS DEVICE FOR PERSONAL INJURY OR SPECIAL, INCIDENTAL, INDIRECT OR CONSEQUENTIAL DAMAGES OF ANY KIND, INCLUDING WITHOUT LIMITATION DAMAGES FOR ATTORNEY'S FEES, LOST DATA OR LOST PROFITS, REGARDLESS OF THE THEORY OF LIABILITY AND WHETHER OR NOT ADVISED OF THE POSSIBILITY OF SUCH DAMAGES. IN NO EVENT WILL PIONEER'S TOTAL LIABILITY TO YOU FOR ALL DAMAGES ARISING FROM THE USE OR INABILITY TO USE THIRD PARTY CONTENT SERVICES (OTHER THAN AS MAY BE REQUIRED BY LAW IN CASES INVOLVING PERSONAL INJURY) EXCEED \$10.00. THE FOREGOING LIMITATIONS WILL APPLY EVEN IF THE ABOVE REMEDY FAILS OF ITS ESSENTIAL PURPOSE. IF ANY APPLICABLE AUTHORITY HOLDS ANY PORTION OF THIS SECTION TO BE UNENFORCEABLE, THEN LIABILITY WILL BE LIMITED TO THE MAXIMUM EXTENT PERMITTED BY APPLICABLE LAW.

About playback behavior over a network

- Playback may stall when the PC is switched off or any media files stored on it are deleted while playing content.
- If there are problems within the network environment (heavy network traffic, etc.) content may not be displayed or played properly (playback may be interrupted or stalled). For best performance, a 100BASE-TX connection between player and PC is recommended.
- If several clients are playing simultaneously, as the case may be, playback is interrupted or stalled.
- Depending on the security software installed on a connected PC and the setting of such software, network connection may be blocked.

Pioneer is not responsible for any malfunction of the player and/or the NETWORK features due to communication error/malfunctions associated with your network connection and/or your PC, or other connected equipment. Please contact your PC manufacturer or Internet service provider.

"Windows Media™" is a trademark of Microsoft Corporation.

This product includes technology owned by Microsoft Corporation and cannot be used or distributed without a license from Microsoft Licensing, Inc.

Microsoft® Windows® 7, Windows® Vista, Windows® XP, Windows® 2000, Windows® Millennium Edition, Windows® 98, and WindowsNT® are either registered trademarks or trademarks of Microsoft Corporation in the United States and/or other countries.

Glossary

aacPlus

AAC decoder uses aacPlus developed by Coding Technologies. (www.codingtechnologies.com)



FLAC

FLAC (Free Lossless Audio Codec) is an audio format that allows lossless audio. Audio is compressed in FLAC without any loss in quality. For more details about FLAC, visit the following website: <http://flac.sourceforge.net/>

vTuner

vTuner is a paid online database service that allows you to listen to radio and TV broadcasts on the Internet. vTuner lists thousands of stations from over 100 different countries around the globe. For more detail about vTuner, visit the following website:

<http://www.radio-pioneer.com>

"This product is protected by certain intellectual property rights of NEMS and BridgeCo. Use or distribution of such technology outside of this product is prohibited without a license from NEMS and BridgeCo or an authorized subsidiary."

Windows Media

Windows Media is a multimedia framework for media creation and distribution for Microsoft Windows. Windows Media is either a registered trademark or trademark of Microsoft Corporation in the U.S. and/or other countries. Use an application licensed by Microsoft Corporation to author, distribute, or play Windows Media formatted content. Using an application unauthorized by Microsoft Corporation is subject to malfunction.

Windows Media DRM

Windows Media DRM is a DRM (Digital Rights Management) service for the Windows Media platform. It is designed to provide secure delivery of audio and/or video content over an IP network to a PC or other playback device in such a way that the distributor can control how that content is used. The WMDRM-protected content can only be played back on a component supporting the WMDRM service.

Windows Media Player 11/ Windows Media Player 12

Windows Media Player is software to deliver music, photos and movies from a Microsoft Windows computer to home stereo systems and TVs.

With this software, you can play back files stored on the PC through various devices wherever you like in your home.

This software can be downloaded from Microsoft's website.

- Windows Media Player 11 (for Windows XP or Windows Vista)
- Windows Media Player 12 (for Windows 7)

For more information check the official Microsoft website.

About playable file formats

The NETWORK feature of this receiver supports the following file formats. Note that some file formats are not available for playback although they are listed as playable file formats. Also, the compatibility of file formats varies depending on the type of server. Check with your server to ensure the compatibility of file formats supported by your server.

- Internet radio playback may be affected by the Internet communications environment, and in this case playback may not be possible even with the file formats listed here.

Music files

| Extension | Stream | |
|-----------------------------------|----------------------|--|
| MP3 (MPEG-1 Audio Layer 3) | | |
| .mp3 ^a | Sampling frequency | 32 kHz, 44.1 kHz, 48 kHz |
| | Quantization bitrate | 16 bit |
| | Channel | 2 ch |
| | Bitrate | 8 kbps to 320 kbps |
| | VBR/CBR | Supported/Supported |
| WAV (LPCM) | | |
| .wav | Sampling frequency | 32 kHz, 44.1 kHz, 48 kHz, 88.2 kHz, 96 kHz, 176.4 kHz, 192 kHz |
| | Quantization bitrate | 16 bit, 24 bit |
| | Channel | 2 ch |
| WMA (WMA2/7/8/9) | | |
| .wma ^b | Sampling frequency | 32 kHz, 44.1 kHz, 48 kHz |
| | Quantization bitrate | 16 bit |
| | Channel | 2 ch |
| | Bitrate | 5 kbps to 320 kbps |
| | VBR/CBR | Supported/Supported |

AAC (MPEG-4 AAC LC, MPEG-4 HE AAC (aacPlus v1/2))

| | | |
|------------------------------|----------------------|--------------------------|
| .m4a .aac .3gp .3g2 | Sampling frequency | 32 kHz, 44.1 kHz, 48 kHz |
| | Quantization bitrate | 16 bit |
| | Channel | 2 ch |
| | Bitrate | 16 kbps to 320 kbps |
| VBR/CBR | | Supported/Supported |

FLAC

| | | |
|--------------------|----------------------|--|
| .flac ^c | Sampling frequency | 32 kHz, 44.1 kHz, 48 kHz, 88.2 kHz, 96 kHz, 176.4 kHz, 192 kHz |
| | Quantization bitrate | 16 bit, 24 bit |
| | Channel | 2 ch |

- MPEG Layer-3 audio decoding technology licensed from Fraunhofer IIS and Thomson multimedia.*
- Files encoded using Windows Media Codec 9 may be playable but some parts of the specification are not supported; specifically, Pro, Lossless, Voice.
- Uncompressed FLAC files are not supported. Pioneer does not guarantee playback.



Using the Home Menu

The following section shows you how to make detailed settings to specify how you're using the receiver, and also explains how to fine-tune individual speaker system settings to your liking.

Important

- The OSD will not appear if you have connected using the composite output to your TV. Use HDMI connection for Home Menu.
- If headphones are connected to the receiver, disconnect them.
- You can't use the Home Menu when the **NETRADIO**, **PANDORA**, **M.SERVER**, **FAVORITE**, **iPod/USB** or **ADAPTER** input is selected.

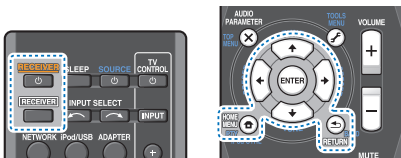

1 Switch on the receiver and your TV.

Press **RECEIVER** to switch on.

2 Switch the TV input to the input that connects this receiver to the TV through the corresponding HDMI cable.

3 Press **RECEIVER**, then press **HOME MENU**.

The Home Menu appears on your TV. Use **↑/↓/←/→** and **ENTER** on the remote control to navigate through the screens and select menu items. Press **RETURN** to exit the current menu.

- Press **HOME MENU** at any time to exit the Home Menu.

4 Select the setting you want to adjust.

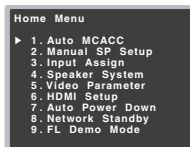

VSX-1022

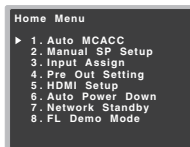

VSX-822

- Auto MCACC** – This is a quick and effective automatic surround setup (see [Automatically setting up for surround sound \(MCACC\) on page 23](#)).
- Manual SP Setup**
 - Speaker Setting** – Specify the size and number of speakers you've connected (see below).
 - X.Over** – Specify which frequencies will be sent to the subwoofer ([page 47](#)).
 - Channel Level** – Adjust the overall balance of your speaker system ([page 48](#)).
 - Speaker Distance** – Specify the distance of your speakers from the listening position ([page 48](#)).
- Input Assign**
 - Analog Input** – Specify what you've connected to the **ANALOG IN1** audio input ([page 49](#)).
 - Component Input (VSX-1022 only)** – Specify what you've connected to the component video inputs ([page 49](#)).
- Speaker System (VSX-1022 only)** – Specifies how you are using the speaker terminals ([page 49](#)).
- Video Parameter (VSX-1022 only)**
 - Video Converter** – Converts video signals for output from the HDMI OUT terminal for all video types ([page 49](#)).
 - Resolution** – Specifies the output resolution of the video signal ([page 50](#)).
 - Aspect** – Specifies the aspect ratio ([page 50](#)).
- Pre Out Setting (VSX-822 only)** – Specify how to use the **PRE OUT SURR BACK/FRONT HEIGHT** outputs (see [The Pre Out Setting \(VSX-822 only\) on page 50](#)).
- HDMI Setup** – Set the audio return channel function or set the HDMI input signal to Standby Through output or not during standby (see [HDMI Setup on page 52](#)).

- Auto Power Down** – Sets to automatically turn off the power when the receiver has not operated for several hours (see [The Auto Power Down menu on page 51](#)).
- Network Standby** – Allows the AirPlay function to be used even when the receiver is in the standby mode (see [The Network Standby menu on page 51](#)).
- FL Demo Mode** – Sets the demo display on the front panel display (see [The FL Demo Mode menu on page 51](#)).

Manual speaker setup

This receiver allows you to make detailed settings to optimize the surround sound performance. You only need to make these settings once (unless you change the placement of your current speaker system or add new speakers).

These settings are designed to fine-tune your system, but if you're satisfied with the settings made in [Automatically setting up for surround sound \(MCACC\) on page 23](#), it isn't necessary to make all of these settings.

Important

- VSX-1022 only:** Depending on the **Speaker System** setting, there will be differences in the speaker items that can be adjusted. The OSD display for these operating instructions is an example of when the **Speaker System** setting is set to **Surr. Back**.
- VSX-822 only:** Depending on the **Pre Out Setting**, there will be differences in the speaker items that can be adjusted. The OSD display for these operating instructions is an example of when the **Pre Out Setting** is set to **Surr. Back**.

Speaker Setting

Use this setting to specify your speaker configuration (size, number of speakers). It is a good idea to make sure that the settings made in [Automatically setting up for surround sound \(MCACC\) on page 23](#) are correct.

1 Select 'Manual SP Setup' from the Home Menu.

2 Select 'Speaker Setting' from the Manual SP Setup menu.



3 Choose the set of speakers that you want to set then select a speaker size.

Use \leftarrow/\rightarrow to select the size (and number) of each of the following speakers:

- **Front** – Select **LARGE** if your front speakers reproduce bass frequencies effectively, or if you didn't connect a subwoofer. Select **SMALL** to send the bass frequencies to the subwoofer.
- **Center** – Select **LARGE** if your center speaker reproduces bass frequencies effectively, or select **SMALL** to send bass frequencies to the other speakers or subwoofer. If you didn't connect a center speaker, choose **NO** (the center channel is sent to the other speakers).
- **Front Height** – Select **LARGE** if your front height speakers reproduce bass frequencies effectively. Select **SMALL** to send bass frequencies to the other speakers or subwoofer. If you didn't connect front height speakers choose **NO**.
 - You can only adjust the **Front Height** setting when **Pre Out Setting** is set to **Height**.
- **Surr** – Select **LARGE** if your surround speakers reproduce bass frequencies effectively. Select **SMALL** to send bass frequencies to the other speakers or subwoofer. If you didn't connect surround speakers choose **NO** (the sound of the surround channels is sent to the other speakers).
- **Surr. Back** – Select the number of surround back speakers you have (one, two or none). Select **LARGE** if your surround back speakers reproduce bass frequencies effectively. Select **SMALL** to send bass frequencies to the other speakers or subwoofer. If you didn't connect surround back speakers choose **NO**.

- *VSX-822 only:* You can only adjust the **Surr. Back** setting when **Pre Out Setting** is set to **Surr. Back**.
- *VSX-822 only:* If you select one surround back speaker only, make sure that additional amplifier is hooked up to the **PRE OUT L (Single)** terminal.
- *VSX-1022 only:* When using only one surround back speaker, connect it to the **SURROUND BACK L (Single)** terminals.
- **Subwoofer** – LFE signals and bass frequencies of channels set to **SMALL** are output from the subwoofer when **YES** is selected (see notes below). Choose the **PLUS** setting if you want the subwoofer to output bass sound continuously or you want deeper bass (the bass frequencies that would normally come out the front and center speakers are also routed to the subwoofer). If you did not connect a subwoofer choose **NO** (the bass frequencies are output from other speakers).

4 When you're finished, press RETURN.

You return to the Manual SP Setup menu.

// Note

- If you select **SMALL** for the front speakers, the subwoofer will automatically be fixed to **YES**. Also, the center, surround, surround back and front height speakers can't be set to **LARGE** if the front speakers are set to **SMALL**. In this case, all bass frequencies are sent to the subwoofer.
- If the surround speakers are set to **NO**, the surround back speakers will automatically be set to **NO**.
- If you have a subwoofer and like lots of bass, it may seem logical to select **LARGE** for your front speakers and **PLUS** for the subwoofer. This may not, however, yield the best bass results. Depending on the speaker placement of your room you may actually experience a decrease in the amount of bass due to low frequency cancellations. In this case, try changing the position or direction of speakers. If you can't get good results, listen to the bass response with it set to **PLUS** and **YES** or the front speakers set to **LARGE** and **SMALL** alternatively and let your ears judge which sounds best. If you're having problems, the easiest option is to route all the bass sounds to the subwoofer by selecting **SMALL** for the front speakers.

X.Over

- Default setting: **100Hz**

This setting decides the cutoff between bass sounds playing back from the speakers selected as **LARGE**, or the subwoofer, and bass sounds playing back from those selected as **SMALL**. It also decides where the cutoff will be for bass sounds in the LFE channel.

- For more on selecting the speaker sizes, see [Speaker Setting on page 46](#).

1 Select 'Manual SP Setup' from the Home Menu.

2 Select 'X.Over' from the Manual SP Setup menu.

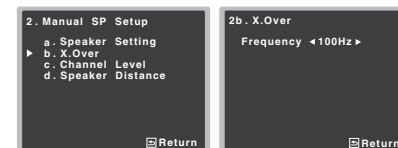

3 Choose the frequency cutoff point.

Frequencies below the cutoff point will be sent to the subwoofer (or **LARGE** speakers).

4 When you're finished, press RETURN.

You return to the Manual SP Setup menu.

Channel Level

Using the channel level settings, you can adjust the overall balance of your speaker system, an important factor when setting up a home theater system.

CAUTION

- The test tones used in the Channel Level settings are output at high volume.

- Select 'Manual SP Setup' from the Home Menu.
- Select 'Channel Level' from the Manual SP Setup menu.



- Select a setup option.
 - Manual** – Move the test tone manually from speaker to speaker and adjust individual channel levels.
 - Auto** – Adjust channel levels as the test tone moves from speaker to speaker automatically.

- Confirm your selected setup option.

The test tones will start after you press **ENTER**. After the volume increases to the reference level, test tones will be output.

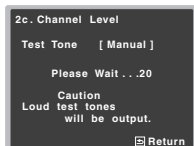

- Adjust the level of each channel using \leftarrow/\rightarrow .

If you selected **Manual**, use \uparrow/\downarrow to switch speakers. The **Auto** setup will output test tones in the order shown on-screen:

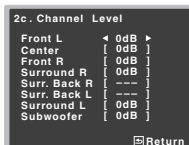

Adjust the level of each speaker as the test tone is emitted.

Note

- If you are using a Sound Pressure Level (SPL) meter, take the readings from your main listening position and adjust the level of each speaker to 75 dB SPL (C-weighting/slow reading).
- The subwoofer test tone is output at low volumes. You may need to adjust the level after testing with an actual soundtrack.

- When you're finished, press **RETURN**.

You return to the Manual SP Setup menu.

Tip

- You can change the channel levels at any time by press **RECEIVER**, then press **CH SELECT** and **LEV +/-** on the remote control. You can also press **CH SELECT** and use \uparrow/\downarrow to select the channel, and then use \leftarrow/\rightarrow to adjust the channel levels.

Speaker Distance

For good sound depth and separation from your system, you need to specify the distance of your speakers from the listening position. The receiver can then add the proper delay needed for effective surround sound.

- Select 'Manual SP Setup' from the Home Menu.
- Select 'Speaker Distance' from the Manual SP Setup menu.

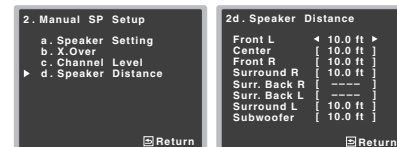

- Adjust the distance of each speaker using \leftarrow/\rightarrow .

You can adjust the distance of each speaker in 0.1 feet increments.

- When you're finished, press **RETURN**.

You return to the Manual SP Setup menu.

The Input Assign menu

Assigns input function for analog audio input terminal and component video input terminal (component video input terminal for VSX-1022 only).

- For the assignment of the digital signal inputs, see [Selecting the audio input signal on page 25](#).

Analog Input

ANALOG IN1 audio input terminal is assigned to **CD** under factory settings, but this can be changed to **TV** input.

- Select 'Input Assign' from the Home Menu.
- Select 'Analog Input' from the Input Assign menu.



VSX-1022

- Select the desired input option for the **ANALOG IN1** audio input terminal.
- When you're finished, press **RETURN**.
You return to the Input Assign menu.

Note

- When playing analog input audio, switch to the **CD** or **TV** input menu, press **RECEIVER** and press **SIGNAL SEL** several times to choose **A** (Analog). (see [Selecting the audio input signal on page 25](#))

Component Input (VSX-1022 only)

COMPONENT VIDEO IN1 input terminal is assigned to **DVD** under factory settings, but this can be changed to **SAT/CBL** input.

- Select 'Input Assign' from the Home Menu.

- Select 'Component Input' from the Input Assign menu.



- Select the desired input option for the **COMPONENT VIDEO IN1** input terminal.

Select between **DVD**, **SAT/CBL** or **OFF**.

- When you're finished, press **RETURN**.
You return to the Input Assign menu.
 - Make sure you have connected the audio from the component to the corresponding inputs on the rear of the receiver.

The Speaker System setting (VSX-1022 only)

Specify either using the surround back speaker (or the speaker B), or the front height speaker connection with the B-speaker terminals.

- Default setting: **Surr. Back**

- Select 'Speaker System' from the Home Menu.

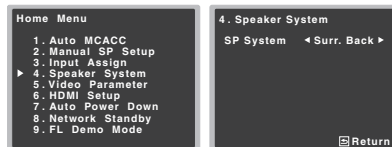

- Select the speaker system setting using **←/→**.

- Surr. Back** – Sound is output from the surround back speaker or the speaker B.
- Height** – Sound is output from front height speaker.

- When you're finished, press **RETURN**.

You return to the Home Menu.

The Video Parameter setting (VSX-1022 only)

This receiver can up-convert the video signal input from the composite or component video terminals; the output is from the **HDMI OUT** terminal. The following shows the various settings for this function.

Video Converter

This setting specifies valid/invalid for the function that converts the input video signal from each composite video terminal. When **OFF** is selected, Resolution and Aspect can not be set.

- Select 'Video Parameter' from the Home Menu.
- Select 'Video Converter' from the Video Parameter menu.



- Select the setting for converting each type of video input.

- ON** – The signal is output also to the **HDMI OUT** terminal.
- OFF** – The signal input from the HDMI terminal of the selected input function will be output from the **HDMI OUT** terminal. The signal input from the composite and component video terminals will not be output from the **HDMI OUT** terminal.

- When you're finished, press **RETURN**.

You return to the Video Parameter menu.

Resolution

Specifies the output resolution of the video signal (when video input signals are output at the HDMI OUT terminal, select this according to the resolution of your monitor and the images you wish to watch).

- This setting is not applicable for video signals input via HDMI.

- Select 'Video Parameter' from the Home Menu.
- Select 'Resolution' from the Video Parameter menu.



- Select output resolution.
 - AUTO** – The resolution is selected automatically according to the capacity of the TV (monitor) connected by HDMI.
 - PURE** – The signals are output with the same resolution as when input.
 - 480p/720p/1080i/1080p** – The signal is output with the resolution specified here (**480p** means the resolution of 480p/576p).

- When you're finished, press **RETURN**.
You return to the Video Parameter menu.

Note

- When set to a resolution with which the TV (monitor) is not compatible, no picture is output. Also, in some cases no picture will be output due to copyright protection signals. In this case, change the setting.

Aspect

Specifies the aspect ratio when analog video input signals are output at the HDMI OUT terminal. Make your desired settings while checking each setting on your display (if the image doesn't match your monitor type, cropping or black bands appear).

- Select 'Video Parameter' from the Home Menu.
- Select 'Aspect' from the Video Parameter menu.



- Select desired output aspect ratio.
 - THROUGH** – The input video signal is output unchanged.
 - NORMAL** – Black bands will appear either at top and bottom or on both sides.
- When you're finished, press **RETURN**.
You return to the Video Parameter menu.

Note

- If the image doesn't match your monitor type, adjust the aspect ratio on the source component or on the monitor.

The Pre Out Setting (VSX-822 only)

Specify either using the surround back speaker or the front height speaker connection with the **PRE OUT SURR BACK/FRONT HEIGHT** outputs. An additional amplifier is required for the speaker connection.

- Default setting: **Surr. Back**

- Select 'Pre Out Setting' from the Home Menu.

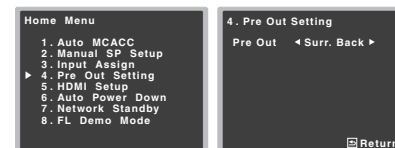

- Select which speaker to connect to the **PRE OUT SURR BACK/FRONT HEIGHT** outputs using **←/→**.
 - Surr. Back** – Connect the surround back speaker.
 - Height** – Connect the front height speaker.
- When you're finished, press **RETURN**.
You return to the Home Menu.

The Auto Power Down menu

Set to automatically turn off the receiver after a specified time has passed (when the power has been on with no operation for several hours).

- Default setting: **OFF**

1 Select 'Auto Power Down' from the Home Menu.

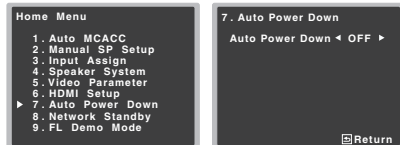

VSX-1022

2 Specify the amount of time to allow before the power is turned off (when there has been no operation).

- You can select 2, 4 or 6 hours, or **OFF** (if no automatic shutoff is desired).

3 When you're finished, press RETURN.

You return to the Home Menu.

Important

- If the **Standby Through** of the **HDMI Setup** is not set to **OFF**, the **Auto Power Down** setting will automatically be set to **OFF** and cannot be changed.

The Network Standby menu

This setting allows the AirPlay function for operating the receiver from a computer connected on the same LAN as the receiver to be used even when the receiver is in the standby mode.

1 Select 'Network Standby' from the Home Menu.

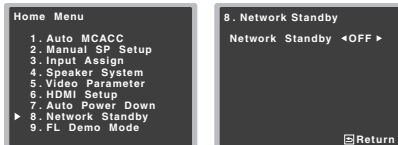

VSX-1022

2 Choose ON or OFF for the Network Standby.

- **ON** – The AirPlay function can be used even when the receiver is in the standby mode.
- **OFF** – The AirPlay function cannot be used when the receiver is in the standby mode (This lets you reduce power consumption in the standby mode).
 - If the **Network Standby** setting is set to **ON**, the power consumption during standby will increase.

3 When you're finished, press RETURN.

You return to the Home Menu.

The FL Demo Mode menu

Set whether or not various demos are to be shown on the front panel display.

1 Select 'FL Demo Mode' from the Home Menu.

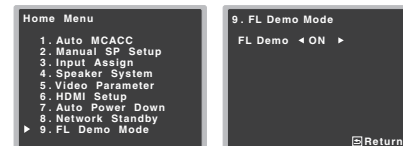

VSX-1022

2 Choose ON or OFF for the demo display.

3 When you're finished, press RETURN.

You return to the Home Menu.

Synchronized operations below with a **Control** with HDMI-compatible Pioneer TV or Blu-ray Disc player are possible when the component is connected to the receiver using an HDMI cable.

• Synchronized amp mode

The receiver's volume can be set and the sound can be muted using the TV's remote control.

• Power synchronization with TV

• Automatic switching of inputs

The receiver's input switches over automatically when the TV's input is changed or a **Control** with HDMI-compatible component is played.

📌 Important

- With Pioneer devices, the **Control** with HDMI functions are referred to as "KURO LINK".
- You cannot use this function with components that do not support **Control** with HDMI.
- We only guarantee this receiver will work with Pioneer made **Control** with HDMI-compatible components. However, we do not guarantee that all synchronized operations will work with components that support the **Control** with HDMI function.
- Use a High Speed HDMI® cable when you want to use the **Control** with HDMI function. The **Control** with HDMI function may not work properly if a different type of HDMI cable is used.
- For details about concrete operations, settings, etc., refer to also the operating instructions for each component.

Making Control with HDMI connections

You can use synchronized operation for a connected TV and other components.

- Be sure to connect the TV's audio cable to the audio input of this unit. When the TV and receiver are connected by HDMI connections, if the TV supports the HDMI Audio Return Channel function, the sound of the TV is input to the receiver via the HDMI terminal, so there is no need to connect an audio cable. In this case, set **ARC at HDMI Setup to ON** (see [HDMI Setup below](#)).

For details, see [Connecting using HDMI on page 17](#).

📌 Important

- When connecting this system or changing connections, be sure to switch the power off and disconnect the power cord from the wall socket.
After completing all connections, connect the power cords to the wall socket.
- After this receiver is connected to an AC outlet, a 2 second to 10 second HDMI initialization process begins. You cannot carry out any operations during initialization. The HDMI indicator on the display unit blinks during initialization, and you can turn this receiver on once it has stopped blinking.
- To get the most out of this function, we recommend that you connect your HDMI component not to a TV but rather directly to the HDMI terminal on this receiver.

HDMI Setup

You must adjust the settings of this receiver as well as the connected **Control** with HDMI-compatible components in order to make use of the **Control** with HDMI function. For more information see the operating instructions for each component.

1 Switch on the receiver and your TV.

Press **RECEIVER** to switch on.

2 Switch the TV input to the input that connects this receiver to the TV through the corresponding HDMI cable.

3 Press **RECEIVER**, then press **HOME MENU**.

The Home Menu appears on your TV. Use **↑/↓/←/→** and **ENTER** on the remote control to navigate through the screens and select menu items. Press **RETURN** to exit the current menu.

- Press **HOME MENU** at any time to exit the Home Menu.

4 Select 'HDMI Setup' from the Home Menu.

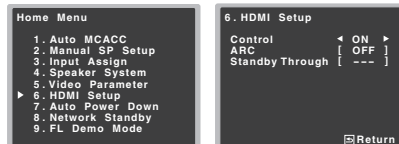

VSX-1022

5 Select the 'Control' setting you want.

Choose whether to set this unit's **Control** with HDMI function **ON** or **OFF**. You will need to set it to **ON** to use the **Control** with HDMI function.

When using a component that does not support the **Control** with HDMI function, set this to **OFF**.

- **ON** – Enables the **Control** with HDMI function. When this unit's power is turned off and you have a supported source begin playback while using the **Control** with HDMI function, the audio and video outputs from the HDMI connection are output from the TV.
- **OFF** – The **Control** with HDMI is disabled. Synchronized operations cannot be used. When this unit's power is turned off, audio and video of sources connected via HDMI are not output.

6 Select the 'ARC' setting you want.

When a TV supporting the HDMI Audio Return Channel function is connected to the receiver, the sound of the TV can be input via the HDMI terminal.

- **ON** – The TV's sound is input via the HDMI terminal. This can only be selected when **Control** is set to **ON**.
- **OFF** – The TV's sound is input from the audio input terminals other than HDMI inputs.

7 Choose the 'Standby Through' setting you want.

When the receiver is in standby, the HDMI input signal selected here will be output to the TV by HDMI.

- **LAST** – The HDMI input signal selected previously will be output. This can only be selected when **Control** is set to **OFF**.

- **BD, DVD, SAT/CBL, DVR/BDR, VIDEO, GAME** – The HDMI input signal selected here will be output. This can only be selected when **Control** is set to **OFF**.
- **OFF** – Signal will not be output during standby.
 - If the **Standby Through** setting is not set to **OFF**, the power consumption during standby will increase. The **Auto Power Down** setting will also be automatically set to **OFF**.

8 When you're finished, press RETURN.

You return to the Home Menu.

Before using synchronization

Once you have finished all connections and settings, you must:

- 1 Put all components into standby mode.
- 2 Turn the power on for all components, with the power for the TV being turned on last.
- 3 Choose the HDMI input to which the TV is connected to this receiver, and see if video output from connected components displays properly on the screen or not.
- 4 Check whether the components connected to all HDMI inputs are properly displayed.

About synchronized operations

The **Control** with HDMI-compatible component connected to the receiver operates in sync as described below.

- **Synchronized amp mode**
 - From the menu screen of the **Control** with HDMI-compatible TV, set audio to be played through this receiver, and the receiver will switch to the synchronized amp mode.
 - When in the synchronized amp mode, the synchronized amp mode is canceled when the receiver's power is turned off. To turn the synchronized amp mode back on, set audio to be played through the receiver from the TV's menu screen, etc. This receiver will power up and switch to the synchronized amp mode.

- When in the synchronized amp mode, the synchronized amp mode is canceled if an operation that produces sound from the TV is performed from the TV's menu screen, etc.
- When the synchronized amp mode is canceled, the receiver's power turns off if you were viewing an HDMI input or a TV program on the TV.
- **Power synchronization with TV**
 - When the TV's power is set to standby, the receiver's power is also set to standby. (Only when the input for a component connected to the receiver by HDMI connection is selected or when watching the TV.)
- **Automatic switching of inputs**
 - The receiver's input switches automatically when the **Control** with HDMI-compatible component is played.
 - The receiver's input switches automatically when the TV's input is switched.
 - The synchronized amp mode remains in effect even if the receiver's input is switched to a component other than one connected by HDMI.

Cautions on the Control with HDMI function

- Connect the TV and components (Blu-ray Disc player, etc.) directly to this receiver. Interrupting a direct connection with other amps or an AV converter (such as an HDMI switch) can cause operational errors.
- When the receiver's **Control** is turned **ON**, even if the receiver's power is in the standby mode, it is possible to output the audio and video signals from a player via HDMI to the TV without producing sound from the receiver, but only when a **Control** with HDMI-compatible component (Blu-ray Disc player, etc.) and compatible TV are connected. In this case, the receiver's power turns on and the power and **HDMI** indicators light.



Setting the remote to control other components

Most components can be assigned to one of the input function buttons using the component's manufacturer preset code stored in the remote.

However, please note that there are cases where only certain functions may be controllable after assigning the proper preset code, or the codes for the manufacturer in the remote control will not work for the model that you are using.

Note

- **TV CONTROL** buttons are only dedicated to control the TV (for example, codes for TV, CATV, Satellite TV or DTV).
- You can cancel or exit any of the steps by pressing **RECEIVER**.
- After one minute of inactivity, the remote automatically exits the operation.

Selecting preset codes directly

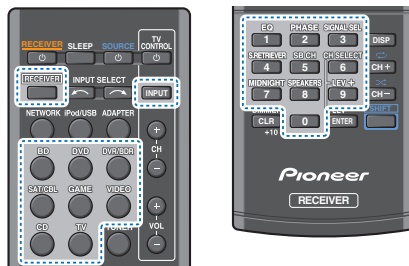

- 1 While pressing **RECEIVER**, press and hold the '1' button for three seconds.
- 2 Press the input function button for the component you want to control.
The component can be assigned to the **BD, DVD, DVR/BDR, SAT/CBL, GAME, VIDEO, CD, or TV** button.
 - When assigning preset codes to **TV CONTROL**, press **INPUT** here.
- 3 Use the number buttons to enter the preset code.
You can find the preset codes on [page 55](#).
If the correct code has been input the power of the component being input will turn on or off.
The power of the component being input will only turn on or off if that component is able to be turned on directly by remote control.
- 4 Repeat steps 2 through 3 to try a different code, or to enter a code for another component you want to control.
- 5 When you're done, press **RECEIVER**.

Clearing all the remote control settings

You can clear all presets and restore the factory default settings.

- ▶ While pressing **RECEIVER**, press and hold the '0' button for three seconds.

Default preset codes

| Input function button | Preset code |
|-----------------------|-------------|
| BD | 2 2 5 5 |
| DVD | 2 2 5 6 |
| DVR/BDR | 2 2 5 7 |
| SAT/CBL | 6 3 2 5 |
| GAME | 5 0 0 3 |
| VIDEO | 6 0 9 9 |
| CD | 5 0 0 0 |
| TV | 0 2 9 1 |
| TV CONTROL | 0 2 9 1 |

Controls for TVs

This remote control can control components (TV, DTV, Satellite TV or Cable TV) after entering the proper codes or teaching the receiver the commands (see [Controlling the rest of your system on page 54](#) for more on this). Use the input function buttons to select the component.

- The **TV CONTROL** buttons on the remote control are dedicated to control the TV assigned to the **TV CONTROL INPUT** button.

| Button(s) | Function |
|---------------------------|---|
| TV CONTROL | Switches the TV between standby and on. |
| TV CONTROL INPUT | Switches the TV input. (Not possible with all models.) |
| TV CONTROL CH +/- | Selects channels. |
| TV CONTROL VOL +/- | Adjust the TV volume. |
| SOURCE | Press to switch the component assigned to the TV button on or off. |
| HOME MENU | Use as the GUIDE button for navigating. |
| RETURN | Use to select closed captioning with DTV. |
| Number buttons | Use to select a specific TV channel. |
| ENTER | Use to enter a channel. |
| MENU | Press to display the TV menu. |
| ENTER | Press to select or adjust and navigate items on the menu screen. |
| CH +/- | Selects channels. |

Controls for other components

This remote control can control these components (BD, DVD, CD, DVR (BDR), VCR, CD-R) after entering the proper codes or teaching the receiver the commands (see [Controlling the rest of your system on page 54](#) for more on this). Use the input function buttons to select the component.

For *Blu-ray Disc player, DVD player, CD player, DVR (BDR), VCR, CD-R*:

| Button(s) | Function |
|---------------------|---|
| SOURCE | Press to switch the component between standby and on. |
| | Press to return to the start of the current track. Repeated presses skips to the start of previous tracks. |
| | Press to advance to the start of the next track. Repeated presses skips to the start of following tracks. |
| II | Pause playback or recording. |
| | Start playback. |
| | Hold down for fast forward playback. |
| | Hold down for fast reverse playback. |
| | Stops playback (on some models, pressing this when the disc is already stopped will cause the disc tray to open). |
| Number buttons | Use to enter a title/chapter/track number. |
| DISP | Press to display information. |
| TOP MENU | Displays the disc 'top' menu of a BD/DVD player. |
| MENU | Displays menus for the current BD/DVD or DVR you are using. |
| ENTER/RETURN | Navigates BD/DVD menu/options. |
| HOME MENU | Displays the HOME MENU. |
| CH +/- | Selects channels. (DVR/VCR only) |

Preset Code List

You should have no problem controlling a component if you find the manufacturer in this list, but please note that there are cases where codes for the manufacturer in the list will not work for the model that you are using. There are also cases where only certain functions may be controllable after assigning the proper preset code.

Important

- We do not guarantee the operations of all the manufacturers and devices listed. Operation may not be possible even if a preset code is entered.

example:

| | | |
|---------------------|-------|--------------|
| TV | _____ | Category |
| Pioneer 0004 | _____ | Preset code |
| | _____ | Manufacturer |

TV

Pioneer 0004, 0006, 0113, 0233, 0252, 0275, 0291, 0305
Admiral 0001, 0014
Adventura 0012
Aiwa 0002
Akai 0002, 0100
Albatron 0097
Allerion 0009
America Action 0104
Amtron 0008
Anam 0104
Anam National 0003, 0008
AOC 0004, 0008, 0006, 0100
Apex 0021, 0102, 0106
Audiovox 0008, 0104
Aventura 0103
Axion 0094
Bang & Olufsen 0111
Belcor 0004
Bell & Howell 0001
Benq 0064
Bradford 0008, 0104
Brilliant 0109
Brookwood 0004
Broksonic 0104
Candle 0004, 0006, 0012, 0100
Carnivale 0100
Carver 0101
CCE 0110
Celebrity 0002
Celera 0106
Changhong 0106
Citizen 0004, 0006, 0008, 0100
Clarion 0104
Coby 0056
Colortyme 0004, 0006
Concerto 0004, 0006
Contec 0104
Contec/Cony 0007, 0008
Craig 0008, 0104
Crosley 0081, 0101
Crown 0008, 0104
CTX 0063
Curtis Mathes 0000, 0004, 0006, 0014, 0100, 0101
CXC 0008, 0104
Cytron 0093
Daewoo 0004, 0005, 0006, 0023
Daytron 0004, 0006
Dell 0073
DiamondVision 0096
Dimensia 0000
Disney 0046
Dumont 0004, 0011, 0099
Durabrand 0041, 0103, 0104
Dwin 0014
Electroband 0002

Electrograph 0107
Electrohome 0002, 0003, 0004, 0006
Element 0082
Emerson 0004, 0006, 0007, 0008, 0009, 0023, 0103, 0104
Emprex 0092
Envision 0004, 0006, 0100
Epson 0061
ESA 0103
Fujitsu 0009
Funai 0008, 0009, 0103, 0104
Futuretech 0008, 0104
Gateway 0067, 0107, 0108
GE 0000, 0003, 0004, 0006, 0010, 0016, 0039
GFM 0080, 0084
Gibralter 0004, 0011, 0099, 0100
Goldstar 0004, 0005, 0006, 0007, 0100
Gradiente 0066
Grumpy 0008, 0009, 0104
Haier 0112
Hallmark 0004, 0006
Harman/Kardon 0101
Harvard 0008, 0104
Havermey 0014
Hewlett Packard 0053
Hisense 0069
Hitachi 0004, 0006, 0007
Hyundai 0098
Ilo 0089, 0091
IMA 0008
Infinity 0101
InFocus 0074
Initial 0091
Insignia 0085, 0086
Inteq 0099
Janeil 0012
JBL 0101
JC Penney 0000, 0004, 0005, 0006, 0010
JCB 0002
Jensen 0004, 0006
JVC 0007, 0100, 0044
Kawasho 0002, 0004, 0006
KEC 0104
Kenwood 0004, 0006, 0100
KLH 0106
Kloss Novabeam 0008, 0012
KTV 0008, 0100, 0104, 0110
LG 0005, 0052, 0078, 0097
Logik 0001
Luxman 0004, 0006
LXI 0000, 0006, 0101, 0102
Magnavox 0004, 0006, 0019, 0020, 0037, 0042, 0100, 0101
Majestic 0001
Marantz 0004, 0006, 0062, 0100, 0101
Maxent 0087, 0107

Megapower 0097
Megatron 0006
Memorex 0001, 0005, 0006, 0041
MGA 0004, 0005, 0006, 0100
Midland 0010, 0011, 0099
Mintek 0091
Mitsubishi 0004, 0005, 0006, 0014, 0045
Minivision 0097
Montgomery Ward 0001
Motorola 0003, 0014
MTC 0004, 0005, 0006, 0100
Multitech 0008, 0104, 0110
NAD 0006, 0102
NEC 0003, 0004, 0005, 0006, 0100
Net-TV 0107
Nikko 0006, 0100
Norcent 0060
Olevia 0048, 0054, 0059
Onwa 0008, 0104
Oppo 0095
Optimus 0105
Optoma 0075
Optonica 0014
Orion 0025
Panasonic 0003, 0010, 0017, 0027, 0105, 0114
Penney 0100, 0102
Philco 0003, 0004, 0005, 0006, 0007, 0100, 0101
Philips 0003, 0004, 0007, 0019, 0020, 0101
Philips Magnavox 0019
Pilot 0004, 0100
Polaroid 0057, 0106
Portland 0004, 0005, 0006
Prima 0065
Princeton 0097
Prism 0010
Proscan 0000
Proton 0004, 0006, 0007
Protron 0055
Proview 0068
Pulsar 0004, 0011, 0099
Quasar 0003, 0010, 0105
Radio Shack 0100, 0104
Radio Shack/Realistic 0000, 0004, 0006, 0007, 0008
RCA 0000, 0003, 0004, 0005, 0006, 0013, 0024, 0035
Realistic 0100, 0104
Runco 0011, 0099, 0100
Sampo 0004, 0006, 0100, 0107
Samsung 0004, 0005, 0006, 0007, 0022, 0032, 0076, 0077, 0083, 0100, 0110
Sansui 0025
Sanyo 0004, 0005
Sceptre 0072

Scotch 0006
Scott 0004, 0006, 0007, 0008, 0009, 0090, 0104
Sears 0000, 0004, 0006, 0009, 0101, 0102, 0103
Sharp 0004, 0006, 0007, 0014, 0033
Sheng Chia 0014
Shogun 0004
Signature 0001
Sony 0002, 0018, 0029, 0030, 0031, 0034
Soundesign 0004, 0006, 0008, 0009, 0104
Squareview 0103
SSS 0004, 0008, 0104
Starlite 0008, 0104
Superscan 0014
Supre-Macy 0012
Supreme 0002
SVA 0088
Sylvania 0004, 0006, 0049, 0079, 0080, 0100, 0101, 0103
Symphonic 0008, 0041, 0103, 0104
Syntax 0054
Syntax-Brilliant 0054
Tandy 0014
Tatung 0003, 0108
Technics 0010, 0105
Techwood 0004, 0006, 0010
Teknika 0001, 0004, 0005, 0006, 0007, 0008, 0009, 0101, 0104
TMK 0004, 0006
TNCI 0099
Toshiba 0026, 0028, 0036, 0038, 0040, 0043, 0102
Vector Research 0100
Vidtron 0101
Vidtech 0004, 0005, 0006
Viewsonic 0058, 0107
Viking 0012
Viore 0089
Vizio 0004, 0070, 0071, 0108
Wards 0000, 0001, 0004, 0005, 0006, 0009, 0100, 0101
Waycon 0102
Westinghouse 0047, 0051
White Westinghouse 0023
Yamaha 0004, 0005, 0006, 0100
Zenith 0001, 0004, 0011, 0015, 0099

DVD

If operations are not possible using the preset codes below, you may be able to conduct operations with the preset codes for the **BD, DVR (BDR, HDR).**

Pioneer 2014, 2197, 2256

Accurian 2092
Advent 0072
Aiwa 2012
Akai 2066
Alco 2070
Allegro 2087
Amphion MediaWorks 2037
AMW 2037
Apex 2002, 2018, 2079, 2080
Apple 2058
Argo 2088
Aspire 2073
Astar 2052
Audiovox 2070
Axion 2040

Bang & Olufsen 2081
Blaupunkt 2080
Blue Parade 2078
Boston 2059
Broksonic 2066
California Audio Labs 2068
CambridgeSoundWorks 2065
CineVision 2087
Coby 2029
Curtis Mathes 2089
CyberHome 2000, 2088
Cytron 2039
Daewoo 2021, 2087
Denon 2026, 2068
Desay 2055
DiamondVision 2042
Disney 2022
Durabrand 2090
Emerson 2067, 2082, 2091
Enterprise 2082
ESA 2053, 2091
Fisher 2083
Funai 2091
GE 2016, 2077, 2080
GFM 2043
Go Video 2087
Gradiente 2068
Greenhill 2080

Haier 2094
Harman/Kardon 2030, 2084
Hitachi 2011
Hiteker 2079
iLive 2062
Ilo 2038
Initial 2038, 2080
Insignia 2036, 2064, 2091
Integra 2078
iSymphony 2060
JBL 2084
JVC 2013
Kawasaki 2070
Kenwood 2028, 2068
KLH 2070, 2080

Koss 2024, 2069, 2075
Landel 2093
Lasonic 2085
Lennox 2074, 2090
LG 2019, 2051, 2061, 2082, 2087
Liquid Video 2075
Liteon 2026, 2092
Magnavox 2067, 2076, 2091
Memorex 2066
Microsoft 2077
Mintek 2038, 2080, 2086
Mitsubishi 2020

Nesa 2080
Next Base 2093
Nexxtech 2066
Onkyo 2076
Oppo 2041, 2057
Oritron 2069, 2075
Panasonic 2006, 2007, 2017, 2032, 2033, 2050, 2068, 2076
Philips 2045, 2076
Proceed 2079
Proscan 2077
Qwestar 2069

RCA 2008, 2016, 2070, 2077, 2078, 2080
Regent 2074
Rio 2087
Rowa 2071
Samsung 2009, 2011, 2015, 2031, 2044, 2068
Sansui 2066
Sanyo 2066, 2083
Sharp 2035
Sherwood 2063
Shinonic 2086
Sonic Blue 2087
Sony 2003, 2004, 2010, 2012, 2027, 2046, 2047, 2048
Sungale 2054
Superscan 2067
Sylvania 2023, 2067, 2091
Symphonic 2023

Teac 2070
Technics 2068
Theta Digital 2078
Toshiba 2001, 2006, 2049, 2066, 2076
Trutech 2000
Urban Concepts 2076
US Logic 2086
Venturer 2070
Xbox 2077
Yamaha 2005, 2068
Zenith 2019, 2076, 2082, 2087

BD

If operations are not possible using the preset codes below, you may be able to conduct operations with the preset codes for the **DVD, DVR (BDR, HDR).**

Pioneer 2034, 2192, 2255, 2258, 2259, 2260, 2281
Denon 2310, 2311, 2312
Hitachi 2307, 2308, 2309
JVC 2290, 2291, 2293, 2294, 2295, 2296
LG 2286, 2287
Marantz 2302, 2303
Mitsubishi 2300, 2301
Onkyo 2289
Panasonic 2277, 2278, 2279,
 Philips 2290
Samsung 2282
Sharp 2304, 2305, 2306
Sony 2283, 2284, 2285, 2292
Toshiba 2288, 2262
Yamaha 2297, 2298, 2299

DVR (BDR, HDR)

If operations are not possible using the preset codes below, you may be able to conduct operations with the preset codes for the **DVD, BD.**

Pioneer 2078, 2099, 2107, 2109, 2144, 2193, 2194, 2195, 2196, 2257, 2258, 2259, 2260, 2261, 2264, 2265, 2266, 2270
Panasonic 2263, 2269
Sharp 2267, 2275
Sony 2268, 2271, 2272, 2273, 2276
Toshiba 2274

VCR

Pioneer 1053, 1108

ABS 1017
Adventura 1005
Aiwa 1005
Alienware 1017
American High 1004
Asha 1002
Audio Dynamics 1000
Audiovox 1003
Bang & Olufsen 1032
Beaumarck 1002
Bell & Howell 1001
Calix 1003
Candle 1002, 1003

Canon 1004
Citizen 1002, 1003
Colorbyte 1000
Craig 1002, 1003
Curtis Mathes 1000, 1002, 1004
Cybernet 1002
CyberPower 1017
Daewoo 1005
DBX 1000
Dell 1017
DIRECTV 1016, 1020, 1022, 1023, 1024, 1027, 1030, 1031
Dish Network 1029
Dishpro 1029
Durabrand 1018
Dynatech 1005
Echostar 1029
Electrohome 1003
Electrohome 1003
Emerson 1003, 1004, 1005
Expressvu 1029
Fisher 1001
Fuji 1004
Funai 1005

Garrard 1005
Gateway 1017
GE 1002, 1004
GOI 1029
Goldstar 1000, 1003
Gradiente 1005
Harley Davidson 1005
Harman/Kardon 1000
Headquarter 1001
Hewlett Packard 1017
HNSL 1016
Howard Computers 1017
HP 1017
HTS 1029
Hughes Network Systems 1016, 1020, 1022, 1023, 1024
Humax 1016, 1020
Hush 1017

iBUYPOWER 1017
Instant Replay 1004
JC Penney 1000, 1001, 1002, 1003, 1004
JCL 1004
JVC 1000, 1001, 1020, 1029
Kenwood 1000, 1001
Kodak 1003, 1004
LG 1003
Linksys 1017
Lloyds 1005
LXI 1003
Magnavox 1004, 1018
Magnin 1003
Marantz 1000, 1001, 1004
Marta 1003

Media Center PC 1017
MEI 1004
Memorex 1001, 1002, 1003, 1004, 1005, 1018, 1019
MGN Technology 1002
Microsoft 1017
Mind 1017
Mitsubishi 1010
Motorola 1004
MTC 1002
Multitech 1002, 1005
NEC 1000, 1001
Nikko 1003
Niveus Media 1017
Noblex 1002
Northgate 1017
Olympus 1004
Optimus 1003
Orion 1014, 1019
Panasonic 1004, 1008
Philco 1004
Philips 1004, 1011, 1016, 1020, 1022, 1023, 1024, 1025
Philips Magnavox 1011
Pilot 1003

Proscan 1030
Pulsar 1018
Quarter 1001
Quartz 1001
Quasar 1004
Radio Shack 1003
Radio Shack/Realistic 1001, 1002, 1003, 1004, 1005
Radix 1003
Randex 1003
RCA 1002, 1004, 1007, 1016, 1020, 1022, 1030, 1031
Realistic 1001, 1002, 1003, 1004, 1005
ReplayTV 1029
Ricavision 1017
Runcro 1018
Samsung 1002, 1016, 1022, 1024
Sanky 1010
Sansui 1014, 1019
Sansyo 1001, 1002
Sears 1001, 1003, 1004
Sharp 1012
Shogun 1002
Singer 1004
Sonic Blue 1026
Sony 1006, 1009, 1017, 1021
Stack 1017
STS 1004
Sylvania 1004, 1005
Symphonic 1005
Systemax 1017
Tagar Systems 1017
Tandy 1001
Tashiko 1003

Teac 1005
Technics 1004
Teknika 1003, 1004, 1005
Tivo 1016, 1020, 1021, 1022, 1025
TMK 1002
Toshiba 1015, 1017, 1028
Television 1002, 1003
Touch 1017
UltimateTV 1031
Unitech 1002
Vector Research 1000
Video Concepts 1000
Video sonic 1002
Viewsonic 1017
Voodoo 1017
Wards 1002, 1003, 1004, 1005
XR-1000 1004, 1005
Yamaha 1000, 1001
Zenith 1013, 1018
ZT Group 1017

Satellite Set Top Box

Pioneer 6097, 6098, 6325, 6328, 6329
ADB 6035, 6001
Akai 6102
Alba 6005, 6011, 6013
Allsat 6102
Alltech 6011
Amstrad 6033, 6030, 6044
Antron 6013
Asat 6102
Auster 6000, 6045
Bell ExpressVu 6002, 6003
British Sky Broadcasting 6030
Canal 6105
Chapparral 6034
CNS 6001
Coolsat 6021
Crossdigital 6043
Digenium 6104
Digiwave 6053
DirecTV 6070, 6110, 6111, 6062, 6063, 6113, 6008, 6038, 6054, 6069, 6060, 6059, 6043, 6018, 6114, 6115, 6116, 6093
Dish Network System 6002, 6089, 6003, 6004
Dishpro 6002, 6089, 6004
Echostar 6002, 6089, 6036, 6005, 6003, 6004
Expressvu 6002, 6004
Fortec Star 6123, 6023
Fresat 6014
Funai 6070
GE 6111
General Instrument 6032

GOI 6002, 6004
Grundig 6007, 6030
Hirschmann 6033
Hisense 6020
Hitachi 6038, 6049
Houston 6002
HTS 6002, 6004
Hughes Network Systems 6113, 6038, 6054, 6114, 6115, 6116
Hyundai 6016
iLO 6020
Innova 6059
Jerrold 6003
JVC 6002, 6003, 6004
Kathrein 6096
Lava 6053
LG 6047, 6018
Marantz 6102
McIntosh 6032
Mitsubishi 6038
Motorola 6032, 6042
NEC 6050
Netsat 6059
Next Level 6032
nfusion 6015
Nokia 6025, 6026, 6118, 6119, 6121
Pace 6035, 6005, 6030, 6031
Panarex 6016
Panasonic 6008, 6009, 6030
Pansat 6016, 6022
Philips 6002, 6113, 6038, 6054, 6060, 6059, 6102, 6103, 6030, 6114
Primestar 6032
Proscan 6110, 6111
Proton 6020

RadioShack 6002, 6111, 6032
RADIX 6036
RCA 6002, 6110, 6111, 6113, 6109, 6061, 6114
Saba 6014
Sagem 6041, 6120
Samsung 6070, 6113, 6091, 6043, 6017, 6114, 6093
Sanyo 6046
Sat Cruiser 6015
Schwaiger 6066
Siemens 6007, 6036
SKY 6042, 6059, 6030, 6031
SM Electronic 6011
Smart 6051
Sonicview 6055, 6107
Sony 6062, 6063, 6030
Star Choice 6032
Star Trak 6032
TechniSat 6033
Thomson 6110, 6111, 6014
Tivo 6113, 6114, 6115, 6116

Toshiba 6038, 6054, 6039
TPS 6041
Triasat 6033
Ultrasat 6021
US Digital 6020
USDTV 6020
ViewSat 6048
Voom 6032
Zehnder 6101
Zenith 6042, 6069, 6037

Satellite Set Top Box (SAT/PVR Combination)

Bell ExpressVu 6002, 6003
DirecTV 6070, 6110, 6062, 6113, 6060, 6059, 6114, 6115, 6116
Dish Network System 6002, 6089
Dishpro 6002, 6089
Echostar 6002, 6089, 6003
Expressvu 6002
Hughes Network Systems 6113, 6114, 6115, 6116
JVC 6003
Motorola 6032
Philips 6113, 6114
Proscan 6110
Samsung 6114
Sonicview 6055, 6107
Sony 6062
Star Choice 6032
Tivo 6113, 6114, 6115, 6116

Cable Set Top Box

Pioneer 0297, 6028, 6029, 6095, 6099, 6325, 6328, 6329
ABC 6122
Accuphase 6122
Amino 6077, 6078
Auna 6082
BCC 6072
Bell & Howell 6122
Bright House 6074, 6029
Cable One 6074, 6029
Cablevision 6074, 6029
Charter 6074, 6029, 6058
Cisco 6029, 6028, 6083
Comcast 6074, 6029, 1982
Cox 6074, 6029
Digeo 6029, 6058
Director 6073
Emerson 6122
Fogstate 6072
General Instrument 6073, 6072, 6122
Homecast 6024

i3 Micro 6077
Insight 6074, 6073, 6029
Jebsee 6122
Jerrold 6073, 6072, 6122
Knology 6029
Macab 6040
Mediacom 6074, 6029
Memorex 6112
Motorola 6074, 6073, 6072, 6029, 6122, 6094
MTS 6094
Myrio 6077, 6078
Noos 6040
Pace 6074, 6029, 6028, 6106, 6083
Panasonic 6112, 6083
Paragon 6112
Pennney 6112
Philips 6012
Pulsar 6112
Quasar 6112
Regal 6072
Rogers 6029
Runco 6112
Samsung 6095
Scientific Atlanta 6029, 6028, 6027, 6112
Sejin 6077
Shaw 6074
Starcom 6122
Stargate 6122
Suddenlink 6074, 6029
Supercable 6072
Time Warner 6074, 6029, 6058
Tivo 6076
Toshiba 6112
United Cable 6072, 6122
US Electronics 6072
Videoway 6112
Zenith 6112

Cable Set Top Box (Cable/PVR Combination)

Pioneer 6029, 6325, 6328, 6329
Amino 6078
Bright House 6074, 6029
Cable One 6074, 6029
Cablevision 6074, 6029
Charter 6074, 6029, 6058
Cisco 6029, 6083
Comcast 6074, 6029, 6083, 6076
Cox 6074, 6029
Digeo 6081, 6058
Homecast 6024

Insight 6074, 6029
Knology 6029
Mediacom 6074, 6029
Motorola 6074, 6081
Myrio 6078
Pace 6029
Panasonic 6083
Rogers 6029
Scientific Atlanta 6029
Shaw 6074
Suddenlink 6074, 6029
Supercable 6072
Time Warner 6074, 6029, 6058
Tivo 6076

CD

Pioneer 5000, 5011, 5070
AKAI 5043
Asuka 5045
Denon 5019
Fisher 5048
Goldstar 5040
Hitachi 5042
Kenwood 5020, 5021, 5031
Luxman 5049
Marantz 5033
Onkyo 5017, 5018, 5030, 5050
Panasonic 5036
Philips 5022, 5032, 5044
RCA 5013, 5029
Roadstar 5052
Sharp 5051
Sony 5012, 5023, 5026, 5027, 5028, 5039
TEAC 5015, 5016, 5034, 5035, 5037
Technics 5041
Victor 5014
Yamaha 5024, 5025, 5038, 5046, 5047

CD-R

Pioneer 5001, 5053, 5071
Philips 5054
Yamaha 5055

Tuner

Pioneer 5060

Laser Disc Player

Pioneer 5002, 5003

Cassette Deck

Pioneer 5058, 5059

Digital Tape

Pioneer 5057

MD

Pioneer 5056

Network Audio Player

Pioneer 5063

Game

X-Box 2313

AV Receiver

Pioneer 5062



Troubleshooting

Incorrect operations are often mistaken for trouble and malfunctions. If you think that there is something wrong with this component, check the points below. Take a look at the other components and electrical appliances being used, because sometimes the problem may lie there. If the trouble isn't sorted out even after going through the checks below, ask your nearest Pioneer authorized independent service company to carry out repair work.

- If the unit does not operate normally due to external effects such as static electricity disconnect the power plug from the outlet and insert again to return to normal operating conditions.

General

❖ The power does not turn on.

- Disconnect the power plug from the outlet, and insert again.
- Make sure there are no loose strands of speaker wire touching the rear panel. This could cause the receiver to shut off automatically.

❖ The receiver suddenly switches off.

- When the Auto Power Down function is working, the power will automatically turn off if the receiver has not operated for several hours. Check the setting for the Auto Power Down function (see [The Auto Power Down menu on page 51](#)).
- After about a minute (you won't be able to switch the unit on during this time), switch the receiver back on. If the message persists, call a Pioneer authorized independent service company.

❖ The power suddenly turns on or off, or the input suddenly changes (When the Control with HDMI is ON).

- This happens because of the synchronized operation due to the **Control** with HDMI function. If synchronized operations are not needed, set the **Control** with HDMI to **OFF** (see [HDMI Setup on page 52](#)).

❖ OVERHEAT shows in the display and the power turns off.

- The temperature within the unit has exceeded the allowable value. Try moving the unit for better ventilation ([page 2](#)).
- Lower the volume level.

❖ TEMP shows in the display and the volume level drops.

- The temperature within the unit has exceeded the allowable value. Try moving the unit for better ventilation ([page 2](#)).
- Lower the volume level.

❖ No sound is output when an input function is selected.

- Use **VOLUME +/-** to turn up the volume.
- Press **MUTE** on the remote control to turn muting off.
- Press **SPEAKERS** to select the proper speaker set (see [Switching the speaker terminal on page 14](#)).
- Set the **SIGNAL SEL** to **H** (HDMI), **C1/O1** (digital) or **A** (analog) according to the type of connections made ([page 25](#)).
- Make sure the component is connected correctly (refer to [Connecting your equipment on page 11](#)).
- Check the audio output settings of the source component.
- Refer to the instruction manual supplied with the source component.

❖ No image is output when an input function is selected.

- Make sure the component is connected correctly (refer to [Connecting your equipment on page 11](#)).
- *V SX-822 only*: Use the same type of video cables for the source component and TV to connect to this receiver (see [About video outputs connection \(V SX-822 only\) on page 16](#)).
- *V SX-1022 only*: Check [The Input Assign menu on page 49](#) to make sure you're assigned the correct input.
- The video input selected on the TV monitor is incorrect. Refer to the instruction manual supplied with the TV.
- *V SX-1022 only*: For HDMI, or when Video Converter is set to **OFF** and a TV and another component are connected with different cords (in [Video Converter on page 49](#)), you must connect your TV to this receiver using the same type of video cable as you used to connect your video component.
- *V SX-1022 only*: Some components (such as video game units) have resolutions that may not be converted. If adjusting this receiver's Resolution setting (in [Resolution on page 50](#)) and/or the resolution settings on your component or display doesn't work, try switching Video Converter (in [Video Converter on page 49](#)) **OFF**.

❖ No sound from subwoofer.

- Make sure the subwoofer is switched on.
- If the subwoofer has a volume knob, make sure it's turned up.
- The Dolby Digital or DTS source you are listening to may not have an LFE channel.
- Switch the subwoofer setting in [Speaker Setting on page 46](#) to **YES** or **PLUS**.
- Switch the **LFE ATT** (*LFE Attenuate*) on [page 36](#) to **LFEATT 0** or **LFEATT 5**.

❖ No sound from surround or center speakers.

- Connect the speakers properly ([page 12](#)).
- Refer to [Speaker Setting on page 46](#) to check the speaker settings.
- Refer to [Channel Level on page 48](#) to check the speaker levels.

❖ The OSD screen (Home Menu, etc.) isn't displayed.

- The OSD will not appear if you have connected using the composite output to your TV. Use HDMI connection when setting up the system.

❖ The Phase Control feature doesn't seem to have an audible effect.

- If applicable, check that the lowpass filter switch on your subwoofer is off, or the lowpass cutoff is set to the highest frequency setting. If there is a PHASE setting on your subwoofer, set it to 0° (or depending on the subwoofer, the setting where you think it has the best overall effect on the sound).
- Make sure the speaker distance setting is correct for all speakers (see [Speaker Distance on page 46](#)).

❖ Considerable noise in radio broadcasts.

- Connect the antenna ([page 21](#)) and adjust the position for best reception.
- Route any loose cables away from the antenna terminals and wires.
- Fully extend the FM wire antenna, position for best reception, and secure to a wall (or connect an outdoor FM antenna).
- Connect an additional internal or external AM antenna ([page 21](#)).
- Turn off equipment causing interference or move it away from the receiver (or move antennas farther away from equipment causing noise).

❖ Broadcast stations cannot be selected automatically.

- Connect an outdoor antenna ([page 21](#)).

❖ Noise during playback of a cassette deck.

- Move the cassette deck away from your receiver, until the noise disappears.

❖ No sound is output or a noise is output when software with DTS is played back.

- Make sure the player's settings are correct and/or the DTS signal out is on. Refer to the instruction manual supplied with the DVD player.

❖ There seems to be a time lag between the speakers and the output of the subwoofer.

- See [Automatically setting up for surround sound \(MCACC\) on page 23](#) to set up your system again using MCACC (this will automatically compensate for a delay in the subwoofer output).

❖ **After using the Auto MCACC setup, the speaker size setting (LARGE or SMALL) is incorrect.**

→ Low-frequency noise could have been caused by an air conditioner or motor. Switch off all appliances in the room and rerun the Auto MCACC setup.

❖ **Can't operate the remote control.**

→ Replace the batteries (page 10).
 → Operate within 7 m (23 ft.), 30° of the remote sensor (page 10).
 → Remove the obstacle or operate from another position.
 → Avoid exposing the remote sensor on the front panel to direct light.

❖ **The display is dark or off.**

→ Press **DIMMER** on the remote control repeatedly to return to the default.

❖ **The front panel display switches over for no apparent reason to various different displays.**

→ This happens because the demo display is in operation. To turn off the demo display, press any button to go back to the original display, press any button to go back to the original display, or set the **FL Demo Mode** to **OFF** (see [The FL Demo Mode menu on page 51](#)).

❖ **The receiver doesn't recognize iPod touch/iPhone.**

→ Try the following.
 1. Simultaneously keep pressing the sleep button and home button on the iPod touch or iPhone for over 10 seconds to restart.
 2. Turn on the receiver.
 3. Connect the iPod touch/iPhone to the receiver.

❖ **The Bluetooth wireless technology device cannot be connected or operated. Sound from the Bluetooth wireless technology device is not emitted or the sound is interrupted.**

→ Check that no object that emits electromagnetic waves in the 2.4 GHz band (microwave oven, wireless LAN device or Bluetooth wireless technology apparatus) is near the unit. If such an object is near the unit, set the unit far from it. Or, stop using the object emitting the electromagnetic waves.
 → Check that the Bluetooth wireless technology device is not too far from the unit and that obstructions are not set between the Bluetooth wireless technology device and the unit. Set the Bluetooth wireless technology device and the unit so that the distance between them is less than about 10 m and no obstructions exist between them.
 → Check that the Bluetooth ADAPTER and the ADAPTER PORT terminal of the unit are correctly connected.
 → The Bluetooth wireless technology device may not be set to the communication mode supporting the Bluetooth wireless technology device. Check the setting of the Bluetooth wireless technology device.
 → Check that pairing is correct. The pairing setting was deleted from this unit or the Bluetooth wireless technology device. Reset the pairing.
 → Check that the profile is correct. Use a Bluetooth wireless technology device that supports A2DP profile and AVRCP profile.

NETWORK feature

❖ **Cannot access the network.**

→ The LAN cable is not firmly connected. Firmly connect the LAN cable (page 20).
 → The router is not switched on. Switch on the router.
 → Internet security software is currently installed in the connected component. There are cases where a component with Internet security software installed cannot be accessed.
 → The audio component on the network which has been switched off is switched on. Switch on the audio component on the network before switching on this receiver.

❖ **Playback does not start while 'Connecting Wired...' continues to be displayed.**

→ The component is currently disconnected from this receiver or the power supply. Check whether the component is properly connected to this receiver or the power supply.

❖ **The PC or Internet radio is not properly operated.**

→ The corresponding IP address is not properly set. Switch on the built-in DHCP server function of your router, or set up the network manually according to your network environment (page 51).
 → The IP address is being automatically configured. The automatic configuration process takes time. Please wait.

❖ **The audio files stored on components on the network, such as a PC, cannot be played back.**

→ Windows Media Player 11 or Windows Media Player 12 is not currently installed on your PC. Install Windows Media Player 11 or Windows Media Player 12 on your PC.
 → Audio files recorded in MPEG-4 AAC or FLAC are being played back on Windows Media Player 11 or Windows Media Player 12. Audio files recorded in MPEG-4 AAC or FLAC cannot be played back on Windows Media Player 11 or Windows Media Player 12. Try using another server. Refer to the operation manual supplied with your server.
 → The component connected to the network is not properly operated.
 - Check whether the component is affected by special circumstances or is in the sleep mode.
 - Try rebooting the component if necessary.
 → The component connected to the network does not permit file sharing. Try changing the settings for the component connected to the network.
 → The folder stored on the component connected to the network has been deleted or damaged. Check the folder stored on the component connected to the network.

- Network connections could be restricted due to the computer's network settings, security settings, etc. Check the computer's network settings, security settings, etc.
- ❖ **Cannot access the component connected to the network.**
 - The component connected to the network is not properly set. If the client is automatically authorized, you need to enter the corresponding information again. Check whether the connection status is set to "Do not authorize".
 - There are no playable audio files on the component connected to the network. Check the audio files stored on the component connected to the network.
- ❖ **Audio playback is undesirably stopped or disturbed.**
 - The audio file currently being played back was not recorded in a format playable on this receiver.
 - Check whether the audio file was recorded in a format supported by this receiver.
 - Check whether the folder has been damaged or corrupted.
 - Note that there are cases where even the audio files listed as playable on this receiver cannot be played back or displayed ([page 45](#)).
 - The LAN cable is currently disconnected. Connect the LAN cable properly ([page 20](#)).
 - There is heavy traffic on the network with the Internet being accessed on the same network. Use 100BASE-TX to access the components on the network.
 - When in the DMR mode, depending on the external controller being used, playback may be interrupted when a volume operation is performed from the controller. In this case, adjust the volume from the receiver or remote control.
- ❖ **Cannot access Windows Media Player 11 or Windows Media Player 12.**
 - *In case of Windows Media Player 11:* You are currently logged onto the domain through your PC with Windows XP or Windows Vista installed. Instead of logging onto the domain, log onto the local machine ([page 39](#)).
 - *In case of Windows Media Player 12:* You are currently logged onto the domain through your PC with Windows 7 installed. Instead of logging onto the domain, log onto the local machine ([page 39](#)).

- ❖ **Cannot listen to Internet radio stations.**
 - The firewall settings for components on the network are currently in operation. Check the firewall settings for components on the network.
 - You are currently disconnected from the Internet. Check the connection settings for components on the network, and consult with your network service provider if necessary ([page 41](#)).
 - The broadcasts from an Internet radio station are stopped or interrupted. There are cases where you cannot listen to some Internet radio stations even when they are listed in the list of Internet radio stations on this receiver ([page 39](#)).
- ❖ **The NETWORK function cannot be operated with the buttons on the remote control.**
 - The remote control is not currently set to the NETWORK mode. Press **NETWORK** to set the remote control to the NETWORK mode ([page 43](#)).

HDMI

- ❖ **No picture or sound.**
 - If the problem still persists when connecting your HDMI component directly to your monitor, please consult the component or monitor manual or contact the manufacturer for support.
- ❖ **No picture.**
 - *VSX-822 only:* Video signals that are input from the analog video terminal will not output from the HDMI terminal. Signals that are input from the HDMI terminal will not output from the analog video terminal. Be consistent with the type of cable between input and output.
 - Depending in the output settings of the source component, it may be outputting a video format that can't be displayed. Change the output settings of the source, or connect using the composite video jacks.
 - This receiver is HDCP-compatible. Check that the components you are connecting are also HDCP-compatible. If they are not, please connect them using the composite video jacks.
 - Depending on the connected source component, it's possible that it will not work with this receiver (even if it is HDCP-compatible). In this case, connect using the composite video jacks between source and receiver.
 - If video images do not appear on your TV, try adjusting the resolution, Deep Color or other setting for your component.
 - To output signals in Deep Color, use an HDMI cable (High Speed HDMI® Cable) to connect this receiver to a component or TV with the Deep Color feature.

- ❖ **No sound, or sound suddenly ceases.**
 - Check that the **HDMI** setting is set to **AMP** ([page 36](#)).
 - If the component is a DVI device, use a separate connection for the audio.
 - HDMI format digital audio transmissions require a longer time to be recognized. Due to this, interruption in the audio may occur when switching between audio formats or beginning playback.
 - Turning on/off the device connected to this unit's HDMI OUT terminal during playback, or disconnecting/connecting the HDMI cable during playback, may cause noise or interrupted audio.
- ❖ **Synchronized operation not possible using Control with HDMI function.**
 - Check the HDMI connections.
 - The cable may be damaged.
 - Select **ON** for the **Control** with HDMI setting (see [HDMI Setup on page 52](#)).
 - Turn the TV's power on before turning on this receiver's power.
 - Set the TV side Control with HDMI setting to on (see TV's operating instructions).

Important information regarding the HDMI connection

There are cases where you may not be able to route HDMI signals through this receiver (this depends on the HDMI equipped component you are connecting-check with the manufacturer for HDMI compatibility information). If you aren't receiving HDMI signals properly through this receiver (from your component), please try the following configuration when connecting up.

Configuration A

Connect your HDMI-equipped component directly to the display using an HDMI cable. Then use the most convenient connection (digital is recommended) for sending audio to the receiver. See the operating instructions for more on audio connections. Set the display volume to minimum when using this configuration.

Note

- Depending on the component, audio output may be limited to the number of channels available from the connected display unit (for example audio output is reduced to 2 channels for a monitor with stereo audio limitations).

- If you want to switch the input source, you'll have to switch functions on both the receiver and your display unit.
- Since the sound is muted on the display when using the HDMI connection, you must adjust the volume on the display every time you switch input sources.

Configuration B (VSX-1022 only)

Use component video cables to connect the video output of your HDMI-equipped component to the receiver's component video input. The receiver can then convert the analog component video signal to a digital HDMI signal for transmission to the display. For this configuration, use the most convenient connection (digital is recommended) for sending audio to the receiver. See the operating instructions for more on audio connections.

Note

- The picture quality will change slightly during conversion.

Windows 7



Windows and the Windows logo are trademarks of the Microsoft group of companies.

About iPod/iPhone/iPad

Made for



"Made for iPod," "Made for iPhone" and "Made for iPad" mean that an electronic accessory has been designed to connect specifically to iPod, iPhone, or iPad, respectively, and has been certified by the developer to meet Apple performance standards. Apple is not responsible for the operation of this device or its compliance with safety and regulatory standards. Please note that the use of this accessory with iPod, iPhone, or iPad may affect wireless performance.

Apple, AirPlay, iPad, iPhone, iPod, iPod shuffle, iPod nano, iPod touch, iTunes and Mac are trademarks of Apple Inc., registered in the U.S. and other countries.

The AirPlay logo is a trademark of Apple Inc.

About FLAC

FLAC Decoder

Copyright © 2000, 2001, 2002, 2003, 2004, 2005, 2006, 2007
Josh Coalson

Redistribution and use in source and binary forms, with or without modification, are permitted provided that the following conditions are met:

- Redistributions of source code must retain the above copyright notice, this list of conditions and the following disclaimer.
- Redistributions in binary form must reproduce the above copyright notice, this list of conditions and the following disclaimer in the documentation and/or other materials provided with the distribution.
- Neither the name of the Xiph.org Foundation nor the names of its contributors may be used to endorse or promote products derived from this software without specific prior written permission.

THIS SOFTWARE IS PROVIDED BY THE COPYRIGHT HOLDERS AND CONTRIBUTORS "AS IS" AND ANY EXPRESS OR IMPLIED WARRANTIES, INCLUDING, BUT NOT LIMITED TO, THE IMPLIED WARRANTIES OF MERCHANTABILITY AND FITNESS FOR A PARTICULAR PURPOSE ARE DISCLAIMED. IN NO EVENT SHALL THE FOUNDATION OR CONTRIBUTORS BE LIABLE FOR ANY DIRECT, INDIRECT, INCIDENTAL, SPECIAL, EXEMPLARY, OR CONSEQUENTIAL DAMAGES (INCLUDING, BUT NOT LIMITED TO, PROCUREMENT OF SUBSTITUTE GOODS OR SERVICES; LOSS OF USE, DATA, OR PROFITS; OR BUSINESS INTERRUPTION) HOWEVER CAUSED AND ON ANY THEORY OF LIABILITY, WHETHER IN CONTRACT, STRICT LIABILITY, OR TORT (INCLUDING NEGLIGENCE OR OTHERWISE) ARISING IN ANY WAY OUT OF THE USE OF THIS SOFTWARE, EVEN IF ADVISED OF THE POSSIBILITY OF SUCH DAMAGE.

About messages displayed when using network functions

Refer to the following information when you come up with a status message while operating the Network functions.

| Status messages | Descriptions |
|----------------------------|--|
| Connection Down | The selected category or Internet radio station cannot be accessed. |
| File Format Error | Cannot be played back for some reasons. |
| Track Not Found | The selected song has not been found anywhere on the network. |
| Server Error | The selected server cannot be accessed. |
| Server Disconnected | The server has been disconnected. |
| Empty | There are no files stored in the selected folder. |
| License Error | The license for the contents to be played back is invalid. |
| Item Already Exists | This is displayed when the file you have attempted to register in the Favorites folder has already been registered. |
| Favorite List Full | This is displayed when you have attempted to register a file in the Favorites folder but the Favorites folder is already full. |

Resetting the main unit

Use this procedure to reset all the receiver's settings to the factory default. Use the front panel controls to do this.

- For instructions on resetting the network connection settings, see [Factory Reset on page 42](#).

- 1 **Switch the receiver into standby.**
- 2 **While holding down BAND, press and hold  STANDBY/ON for about two seconds.**
- 3 **When you see RESET? appear in the display, press AUTO SURROUND/STREAM DIRECT. OK? shows in the display.**
- 4 **Press ALC/STANDARD SURR to confirm. OK appears in the display to indicate that the receiver has been reset to the factory default settings.**

Important

- If the **Control** with HDMI function is set to **ON**, you may not be able to reset the unit. In this case, reset either by turning **OFF** the **Control** with HDMI function, or by putting the unit into standby mode by turning off the power of all the connected devices, and resetting after the HDMI indicator on the front panel turns off.

Cleaning the unit

- Use a polishing cloth or dry cloth to wipe off dust and dirt.
- When the surface is dirty, wipe with a soft cloth dipped in some neutral cleanser diluted five or six times with water, and wrung out well, and then wipe again with a dry cloth. Do not use furniture wax or cleansers.
- Never use thinners, benzene, insecticide sprays or other chemicals on or near this unit, since these will corrode the surface.



Manufactured under license from Dolby Laboratories. "Dolby", "Pro Logic", "Surround EX", and the double-D symbol are trademarks of Dolby Laboratories.



Manufactured under license under U.S. Patent Nos: 5,956,674; 5,974,380; 6,226,616; 6,487,535; 7,212,872; 7,333,929; 7,392,195; 7,272,567 & other U.S. and worldwide patents issued & pending. DTS-HD, the Symbol, & DTS-HD and the Symbol together are registered trademarks & DTS-HD Master Audio is a trademark of DTS, Inc. Product includes software. © DTS, Inc. All Rights Reserved.

Specifications

Amplifier section

Continuous average power output of 80 watts* per channel, min., at 8 ohms, from 20 Hz to 20 000 Hz with no more than 0.08 % total harmonic distortion.**

Front (stereo) 80 W + 80 W
Power output (1 kHz, 6 Ω , 1 %) 140 W per channel
Guaranteed speaker impedance 6 Ω to 16 Ω

* Measured pursuant to the Federal Trade Commission's Trade Regulation rule on Power Output Claims for Amplifiers

** Measured by Audio Spectrum Analyzer

Audio Section

Input (Sensitivity/Impedance)
LINE 200 mV/47 k Ω
Signal-to-Noise Ratio (IHF, short circuited, A network)
LINE 98 dB
Signal-to-Noise Ratio [EIA, at 1 W (1 kHz)]
LINE 79 dB

Video Section

Signal level
Composite 1 Vp-p (75 Ω)

Tuner Section

Frequency Range (FM) 87.5 MHz to 108 MHz
Antenna Input (FM) 75 Ω unbalanced
Frequency Range (AM) 530 kHz to 1700 kHz
Antenna (AM) Loop antenna

Digital In/Out Section

HDMI terminal Type A (19-pin)
HDMI output type 5 V, 100 mA
USB terminal USB2.0 High Speed (Type A) 5 V, 2.1 A
iPod terminal USB, and Video (Composite)
ADAPTER PORT terminal 5 V, 100 mA

Network Section

LAN terminal 10 BASE-T/100 BASE-TX

Miscellaneous

Power Requirements AC 120 V, 60 Hz
Power Consumption 520 W (VSX-1022)
450 W (VSX-822)
In standby 0.4 W (Control OFF)
Dimensions 435 mm (W) x 168 mm (H) x 342.5 mm (D)
17³/₁₆ in. (W) x 6⁵/₈ in. (H) x 13¹/₂ in. (D)
Weight (without package) 9.3 kg (20 lb 9 oz) (VSX-1022)
8.9 kg (19 lb 10 oz) (VSX-822)

Furnished Parts

Microphone (for Auto MCACC setup) 1
Remote control 1
Dry cell batteries (AAA size IEC R03) 2
AM loop antenna 1
FM wire antenna 1
iPod cable 1
Warranty card 1
Quick start guide 1
Safety Brochure 1
These operating instructions (CD-ROM)

Note

- Specifications and the design are subject to possible modifications without notice, due to improvements.
- *This product includes FontAvenue® fonts licensed by NEC Corporation. FontAvenue is a registered trademark of NEC Corporation.*

The Safety of Your Ears is in Your Hands

Get the most out of your equipment by playing it at a safe level – a level that lets the sound come through clearly without annoying blaring or distortion and, most importantly, without affecting your sensitive hearing. Sound can be deceiving. Over time, your hearing “comfort level” adapts to higher volumes of sound, so what sounds “normal” can actually be loud and harmful to your hearing. Guard against this by setting your equipment at a safe level BEFORE your hearing adapts.

ESTABLISH A SAFE LEVEL:

- Set your volume control at a low setting.
- Slowly increase the sound until you can hear it comfortably and clearly, without distortion.
- Once you have established a comfortable sound level, set the dial and leave it there.

BE SURE TO OBSERVE THE FOLLOWING GUIDELINES:

- Do not turn up the volume so high that you can't hear what's around you.
- Use caution or temporarily discontinue use in potentially hazardous situations.
- Do not use headphones while operating a motorized vehicle; the use of headphones may create a traffic hazard and is illegal in many areas.

5001a_A1_En

To register your product, find the nearest authorized service location, to purchase replacement parts, operating instructions, or accessories, please go to one of following URLs :

Pour enregistrer votre produit, trouver le service après-vente agréé le plus proche et pour acheter des pièces de rechange, des modes d'emploi ou des accessoires, reportez-vous aux URL suivantes :

In the USA/Aux Etats-Unis

<http://www.pioneerelectronics.com>

In Canada/Aux Canada

<http://www.pioneerelectronics.ca>

S018_B1_EnFr

© 2012 PIONEER CORPORATION.
All rights reserved.

PIONEER CORPORATION

1-1, Shin-ogura, Saiwai-ku, Kawasaki-shi, Kanagawa 212-0031, Japan

PIONEER ELECTRONICS (USA) INC.

P.O. BOX 1540, Long Beach, California 90801-1540, U.S.A. TEL: (800) 421-1404

PIONEER ELECTRONICS OF CANADA, INC.

340 Ferrier Street, Unit 2, Markham, Ontario L3R 2Z5, Canada TEL: 1-877-283-5901, 905-479-4411

PIONEER EUROPE NV

Haven 1087, Keetberglaan 1, B-9120 Melsele, Belgium TEL: 03/570.05.11

PIONEER ELECTRONICS ASIACENTRE PTE. LTD.

253 Alexandra Road, #04-01, Singapore 159936 TEL: 65-6472-7555

PIONEER ELECTRONICS AUSTRALIA PTY. LTD.

5 Arco Lane, Heatherton, Victoria, 3202, Australia, TEL: (03) 9586-6300

PIONEER ELECTRONICS DE MEXICO S.A. DE C.V.

Bldv.Manuel Avila Camacho 138 10 piso Col.Lomas de Chapultepec, Mexico, D.F. 11000 TEL: 55-9178-4270

K002_B3_En

<ARB7470-B>