

Basic Manual

TX-NR676 / TX-NR676E / AV RECEIVER

Before Start	2
What's in the box.....	2
Part Names	3
Part Names	3
Install	7
Installation procedure.....	7
Step1: Speaker Layout.....	8
Step2: Connect the Speakers.....	14
Step3: Connect the TV & AV Components.....	16
Initial Setup	22
Initial Setup with Auto Start-up Wizard	22
Playback	24
AV Component Playback.....	24
BLUETOOTH® Playback.....	24
Network Functions.....	25
USB Storage Device	26
Listening to the AM/FM Radio.....	27
Multi-zone.....	29
Listening Mode.....	30

For details about the Network Functions and listening modes, and information regarding the advanced settings, refer to the "Advanced Manual" available on our website.
<http://www.onkyo.com/manual/txnr676/adv/en.html>

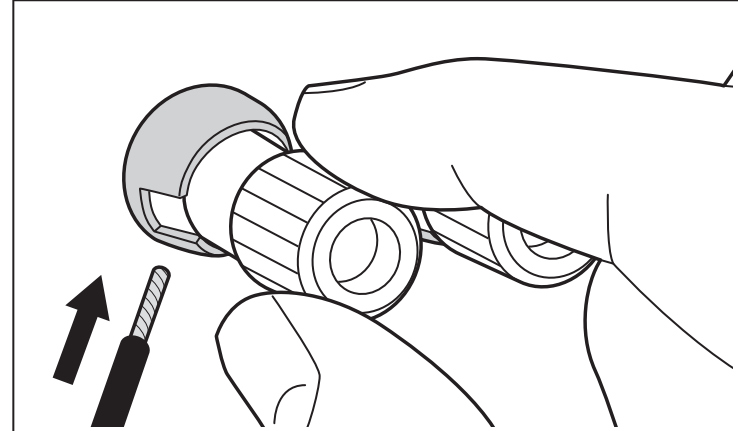
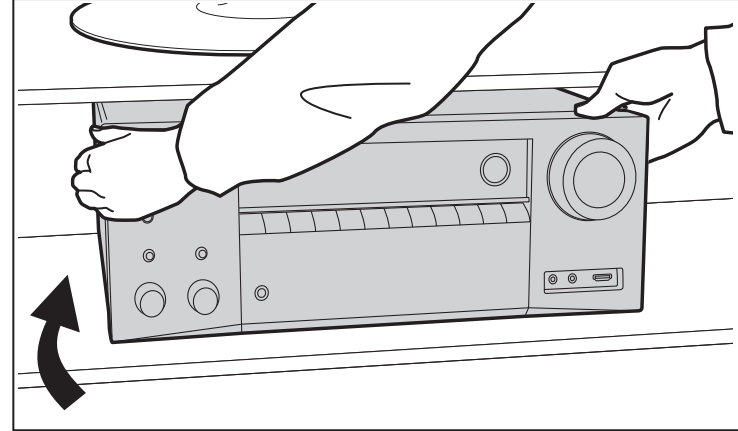

What's in the box

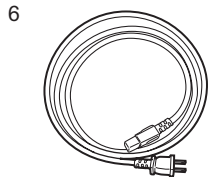
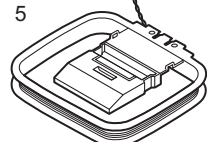
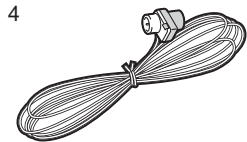
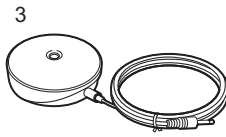
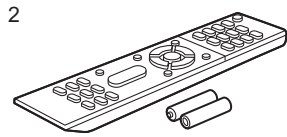
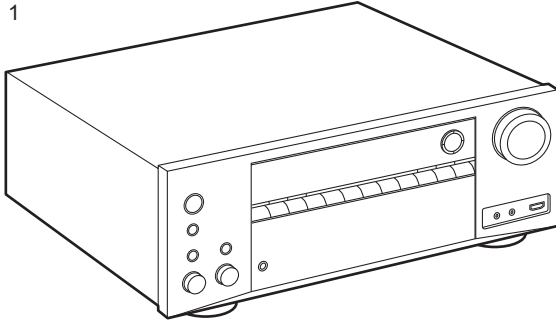

1. Main unit (1)
 2. Remote controller (RC-911R) (1), Batteries (AAA/R03) (2)
 3. Speaker setup microphone (1)
 - Used during Initial Setup.
 4. Indoor FM antenna (1)
 5. AM loop antenna (1)
 6. Power cord (For Taiwanese models only) (1)
 - Quick Start Guide (1)
 - Basic Manual (This manual)
- Connect speakers with 4 Ω to 16 Ω impedance.
 - The power cord must be connected only after all other cable connections are completed.
 - We will not accept responsibility for damage arising from the connection of equipment manufactured by other companies.
 - Functionality may be introduced by firmware updates and service providers may cease services, meaning that some network services and content may become unavailable in the future. Furthermore, available services may vary depending on your area of residence.
 - Details on the firmware update will be posted on our website and through other means at a later date.
 - Specifications and appearance are subject to change without prior notice.

(*)You can find details in the Advanced Manual.

Part Names

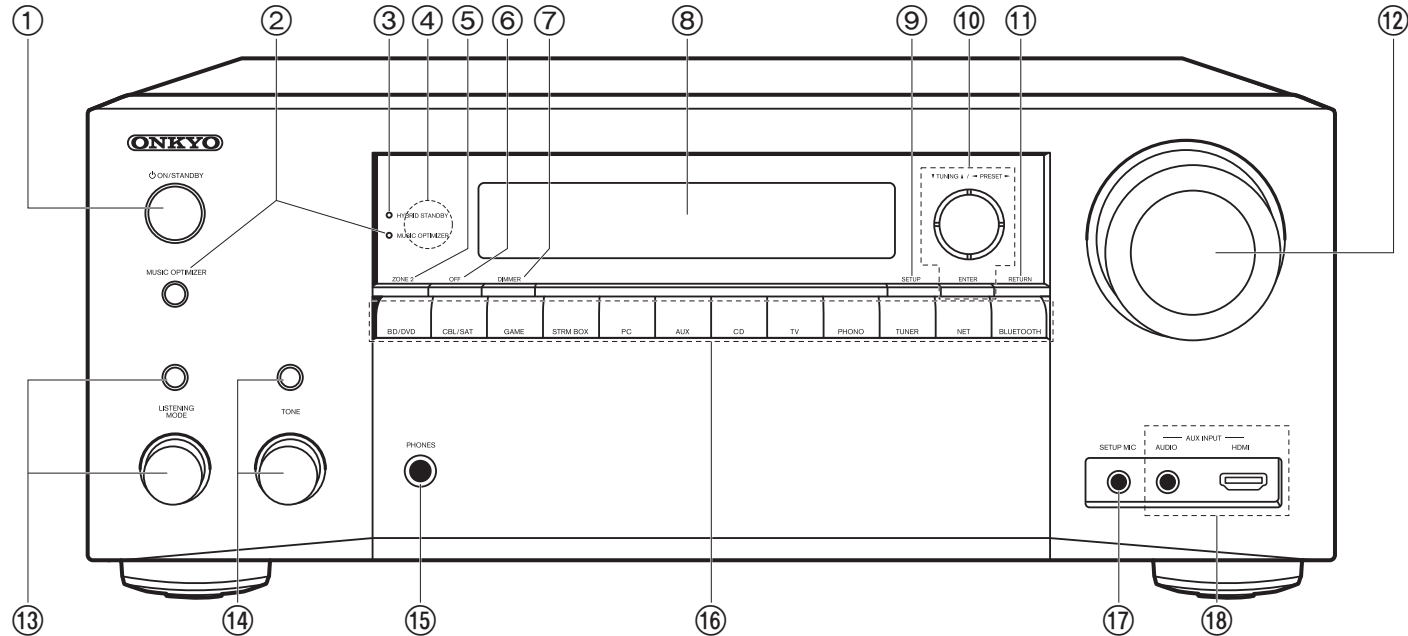

Front Panel

1. ⏻ ON/STANDBY button
2. MUSIC OPTIMIZER button/indicator (North American models): Turns on/off the Music Optimizer function that provides better sound quality for compressed audio.
PURE AUDIO button/indicator (European, Australian, Taiwanese and Asian models): Switches to the Pure Audio mode (P30).
3. HYBRID STANDBY indicator: Lights if the unit enters standby mode when the features are enabled that continue to work when this unit is in standby, such as HDMI Standby Through and Network Standby.
4. Remote control sensor: Receives signals from the remote controller.
 - The signal range of the remote controller is within about 16'5 m, at an angle of 20° on the perpendicular axis and 30° to either side.
5. ZONE 2 button: Controls the multi-zone function (P29).
6. OFF button: Switches the multi-zone function off (P29).
7. DIMMER button: You can adjust the brightness of the display in three steps. It cannot be turned off completely.
8. Display (P4)
9. SETUP button: You can show advanced setting items on the TV and display to provide you with an even better experience. (*)
10. Cursor buttons (▲ / ▼ / ◀ / ▶) and ENTER button: Select the item with the cursors and press ENTER to confirm. Use them to tune to stations when using TUNER (P27).
11. RETURN button: Returns the display to the previous state.
12. MASTER VOLUME
13. Press the LISTENING MODE button (above) repeatedly to select a category from "Movie/TV", "Music", "Game", then turn the LISTENING MODE dial (below) to change the mode (P30). (*)

(*)You can find details in the Advanced Manual.

14. You can adjust the sound quality of the front speakers.
Press the TONE button (above) repeatedly to select the item to adjust from "Bass" and "Treble", and turn the TONE dial (below) to adjust.
15. PHONES jack: Headphones with a standard plug (Ø1/4"/6.3 mm) are connected.
16. Input selector buttons: Switches the input to be played.
17. SETUP MIC jack: The supplied speaker setup microphone is connected.
18. AUX INPUT AUDIO/HDMI jack: Connect a video camera, etc., using a stereo mini plug cable (Ø1/8"/3.5 mm) or a HDMI cable.

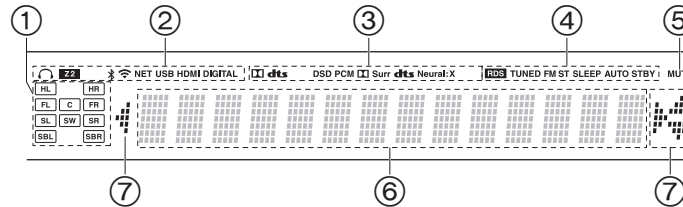

Display

1. Speaker/Channel display: Displays the output channel that corresponds to the selected listening mode.
2. Lights in the following conditions.
 - 🎧: When headphones are connected.
 - Z2: When ZONE 2 is on.
 - 📶: When connected by BLUETOOTH.
 - 📶: When connected by Wi-Fi.
 - NET: When "NET" is selected with the input selector and the unit is connected to the network. It will flash if the connection to the network is not correct.
 - USB: When "NET" is selected with the input selector and the unit is connected by USB and the USB device is selected. Flashes if the USB is not properly connected.
 - HDMI: When HDMI signals are input and the HDMI input is selected.
 - DIGITAL: When digital signals are input and the digital input is selected.
3. Lights according to the type of input digital audio signals and the listening mode.
4. Lights in the following conditions.
 - RDS (European, Australian and Asian models): Receiving RDS broadcasting.
 - TUNED: Receiving AM/FM radio.
 - FM ST: Receiving FM stereo.
 - SLEEP: When the sleep timer is set.
 - AUTO STBY: Auto Standby is on.
5. Flashes when muting is on.
6. Displays various information of the input signals.
7. This may light when performing operations with the "NET" input selector.

(*)You can find details in the Advanced Manual.

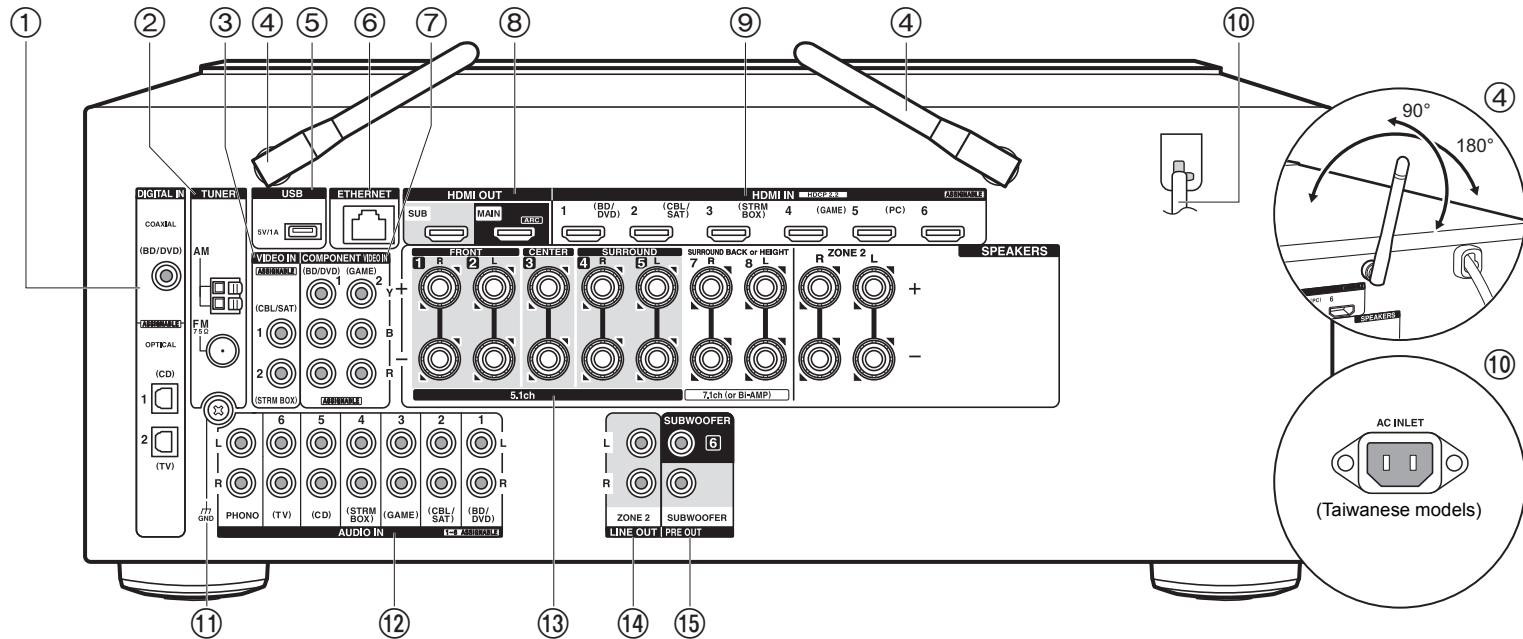

Rear Panel

1. DIGITAL IN OPTICAL/COAXIAL jacks: Input TV or AV component digital audio signals with a digital optical cable or digital coaxial cable.
2. TUNER AM/FM 75Ω terminal: The supplied antennas are connected.
3. VIDEO IN jacks: Input the AV component video signals with an analog video cable.
4. Wireless antenna: Used for Wi-Fi connection or when using a BLUETOOTH wireless technology enabled device. Adjust their angles according to the connection status.
5. USB port: A USB storage device is connected so that music files stored in it can be played. You can also supply power (5 V/1 A) to USB devices with a USB cable.
6. ETHERNET port: Connect to the network with an Ethernet cable.
7. COMPONENT VIDEO IN jacks: Input the AV component video signals with a component video cable. (Compatible only with 480i or 576i resolution.)
8. HDMI OUT jacks: Transmit video signals and audio signals with a HDMI cable connected to a monitor such as a TV or projector.
9. HDMI IN jacks: Transmit video signals and audio signals with a HDMI cable connected to an AV component.
10. Power cord (North American, European, Australian and Asian models)
AC INLET (Taiwanese models): The supplied power cord is connected.
11. GND terminal: The ground wire of the turntable is connected.
12. AUDIO IN jacks: Input TV or AV component audio signals with an analog audio cable.
13. SPEAKERS terminals: Connect speakers with speaker cables. (North American models are compatible with banana plugs.) You can connect the multichannel speakers for the main room and the speakers for a separate room (ZONE 2).
14. ZONE 2 LINE OUT jack: Output audio signals with an analog audio cable to a pre-main amplifier in a separate room (ZONE 2).
15. SUBWOOFER terminals: Connect a subwoofer with a subwoofer cable.

(*)You can find details in the Advanced Manual.

15. SUBWOOFER PRE OUT jack: Connect a powered subwoofer with a subwoofer cable. Up to two powered subwoofers can be connected. The same signal is output from each of the SUBWOOFER PRE OUT jacks.

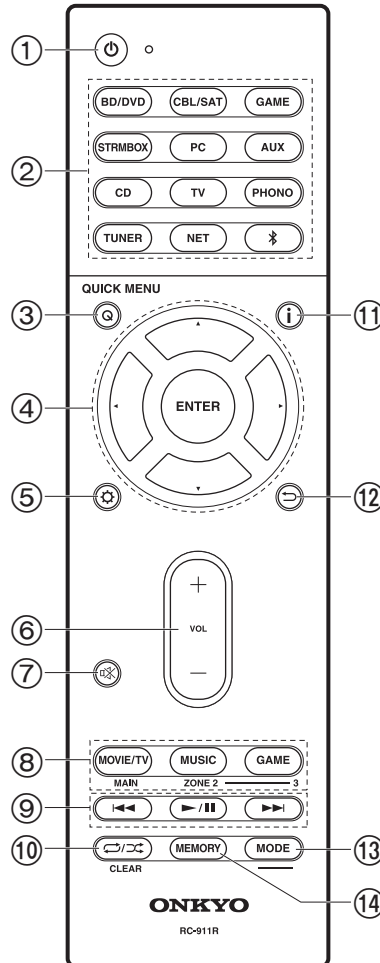

Remote Controller

1. ON/STANDBY button
2. Input selector buttons: Switches the input to be played.
3. Q (QUICK MENU) button: Settings such as "Tone" and "Level" can be made quickly during play on the TV screen. "Other" has settings to switch the speakers given priority for output and to switch HDMI output (P16). (*)
4. Cursor buttons and ENTER button: Select the item with the cursors and press ENTER to confirm your selection. When the folder or file lists are not shown on one screen on the TV, press ◀ / ▶ to change the screen.
5. ⚙ button: You can show advanced setting items on the TV and display to provide you with an even better experience. (*)
6. Volume buttons
7. 🔇 button: Temporarily mutes audio. Press again to cancel muting.
8. LISTENING MODE buttons: Allows you to select the listening mode (P30). (*) MAIN/ZONE 2 buttons: Controls the multi-zone function (P29). (The ZONE 3 button is not used with this unit.)
9. Play buttons: Used for play operations when playing Music Server or USB.
10. ↺/↻ button: You can start repeat/random play of the Music Server or USB. Each time you press the button, the mode switches from 1 (1-track repeat), to 2 (folder repeat), to 3 (random). CLEAR button: Deletes all characters you have entered when entering text on the TV screen.
11. i button: Switches the information on the display and is used to operate RDS (P28).
12. ↶ button: Returns the display to the previous state.
13. MODE button: Switches tuning to an AM/FM radio station between automatic tuning and manual tuning.
14. MEMORY button: Used to register AM/FM radio stations.

Tips

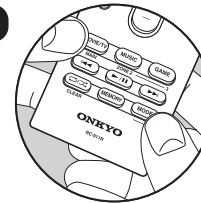

When the remote controller isn't working: The remote controller may have switched to the mode for controlling ZONE 2. While holding down MODE, press MAIN for 3 seconds or more until the remote indicator flashes once to switch it to the mode to control the main room.

Installation procedure



This unit can be used in a number of ways, depending on the layout of the speakers you are installing, and the connections made to external devices. Read the following to help make the installation process smoother.

Step1: Speaker Layout

Select the speaker layout that suits the types of speakers you have and the conditions they will be used in from the choices presented on pages P8 to P12, then install the speakers by referring to the illustrations and explanations on the relevant page. Speaker layouts include systems that use surround back speakers, systems that use height speakers, and systems that use Bi-Amping speakers. Also refer to the combinations available in "Speaker combinations" on P13.

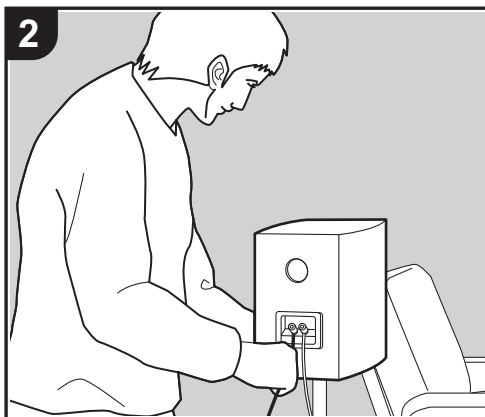

Step2: Connect the Speakers

To connect the speaker systems to this unit, refer to P14 if you are using a speaker layout described on one of P8 to P11, and to P15 to use a speaker layout using Bi-Amping speakers described on P12. The connection process will be smoother if you refer to the illustrations and explanations and prepare the required cables before hand.

Step3: Connect the TV & AV Components

Refer to P16 to P21 to connect your external devices such as your TV, Blu-ray Disc Player, and also supplied accessories such as the antennas. Also, P20 introduces the Multi-zone Connection option that allows you to play audio into rooms other than the main room. The connection process will be smoother if you refer to the illustrations and explanations, confirm the connection types on the external devices, and prepare the required cables before hand.

Step1: Speaker Layout

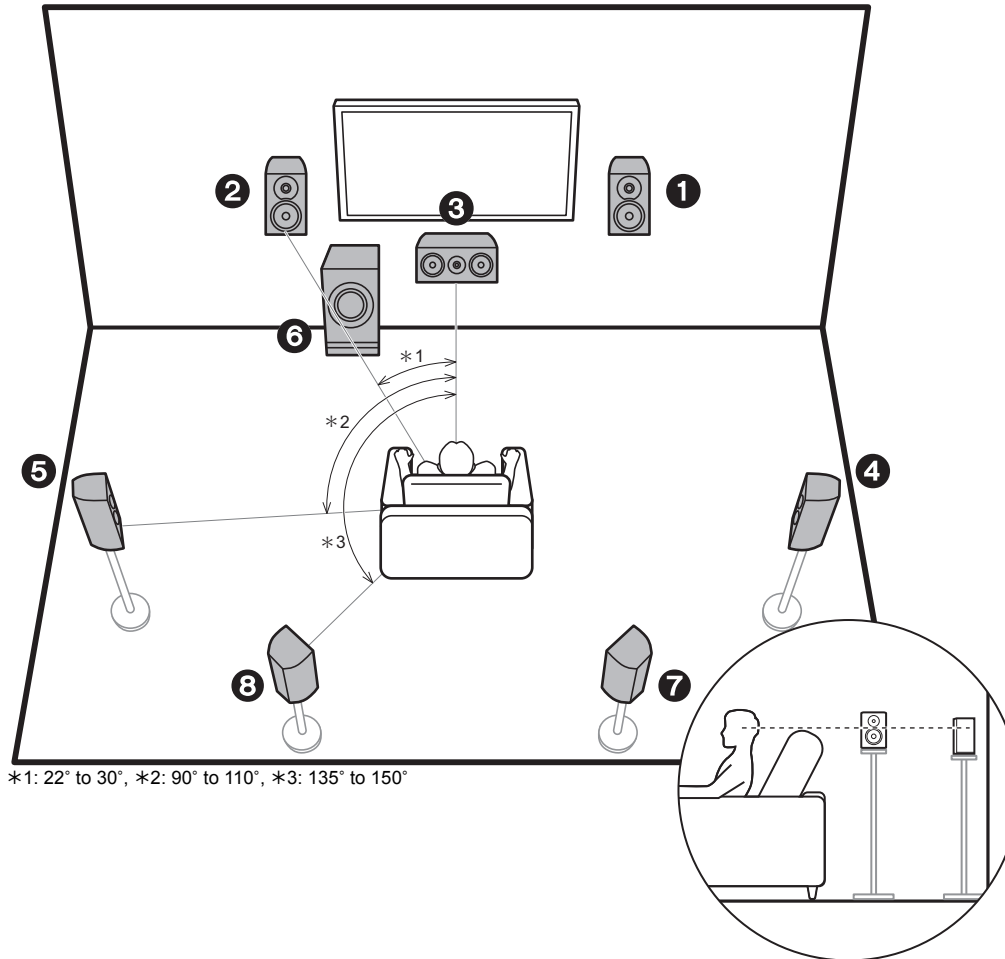

7.1 Channel System

Front speakers output front stereo sound and a center speaker outputs center sound such as dialogs and vocals. Surround speakers create back sound field. Powered subwoofer reproduces bass sounds and creates rich sound field.

This basic 5.1 Channel System with surround back speakers added is called a 7.1 Channel System. The connection of surround back speakers improves the sense of envelopment and connectivity of sound created by the back sound field and provides a more real sound field. Furthermore, by installing surround back speakers, you can select the Dolby Atmos listening mode, which realizes the most up-to-date 3D sound, when the input format is Dolby Atmos.

The front speakers should be positioned at ear height, while the surround speakers should be positioned just above ear height. Center speaker should be set up facing the listening position. Placing the powered subwoofer between the center speaker and a front speaker gives you a natural sound even when playing music. The optimal positioning is for surround back speakers to be at ear height.

- If you are including surround back speakers in the setup, surround speakers are required.
- "Speaker combinations" (P13) introduces some detailed examples of speaker combinations.

- 1,2 Front Speakers
- 3 Center Speaker
- 4,5 Surround Speakers
- 6 Powered Subwoofer
- 7,8 Surround Back Speakers

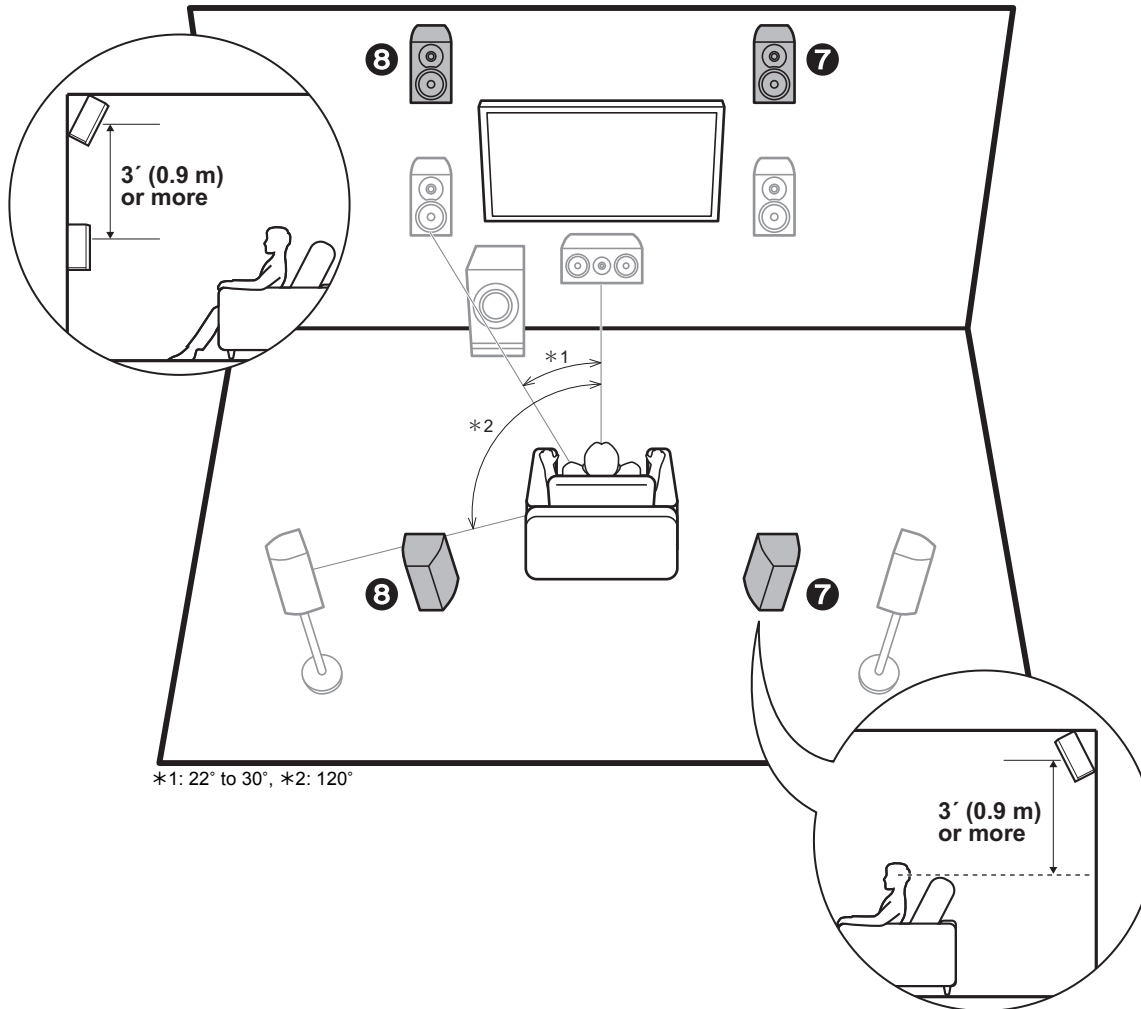

5.1.2 Channel System-1 (Front High Speakers/Rear High Speakers)

This is a basic 5.1 channel system consisting of front speakers, a center speaker, surround speakers, and a powered subwoofer, with the addition of front height speakers or rear high speakers, which are both types of height speakers. By installing height speakers, you can select the Dolby Atmos listening mode, which realizes the most up-to-date 3D sound including overhead sounds, when the input format is Dolby Atmos. Front high speakers or rear high speakers should be situated at least 3' / 0.9 m higher than the front speakers. Front high speakers should be situated directly above the front speakers and the distance between the rear high speakers should match the distance between the front speakers. Both should be set up facing the listening position.

- "Speaker combinations" (P13) introduces some detailed examples of speaker combinations.

7,8 Height Speakers

Choose one of the following:

- Front High Speakers
- Rear High Speakers

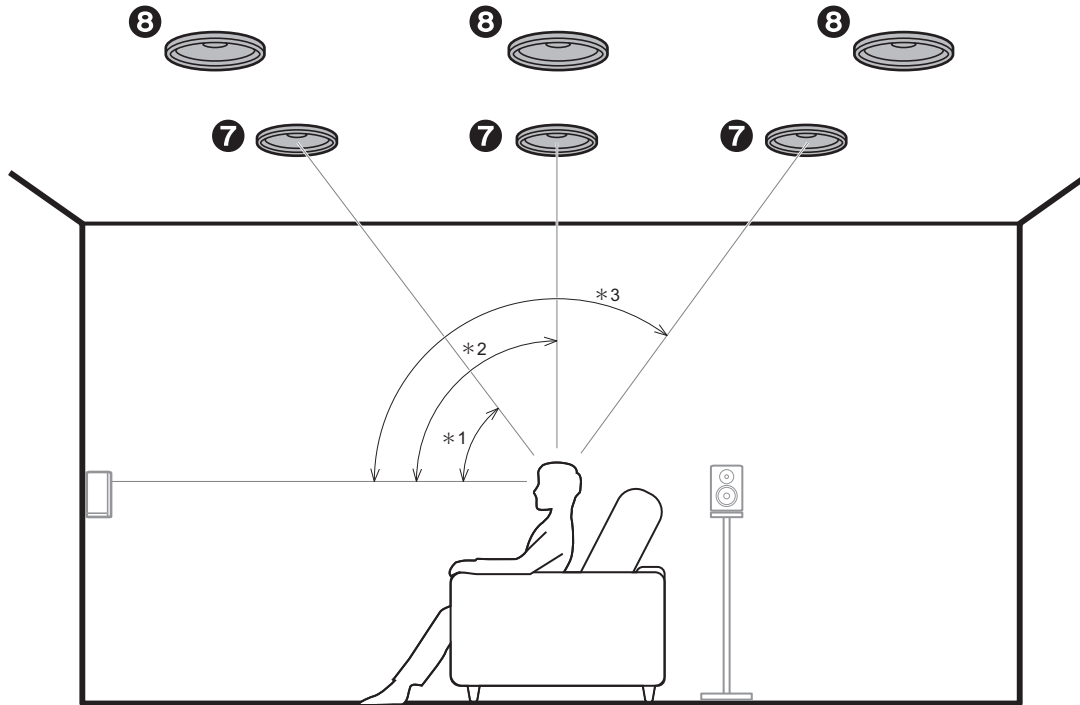

*1: 30° to 55°, *2: 65° to 100°, *3: 125° to 150°

5.1.2 Channel System-2 (Ceiling Speakers)

This is a basic 5.1 channel system consisting of front speakers, a center speaker, surround speakers, and a powered subwoofer, with the addition of top front speakers, top middle speakers, or top rear speakers, which are types of height speakers. By installing height speakers, you can select the Dolby Atmos listening mode, which realizes the most up-to-date 3D sound including overhead sounds, when the input format is Dolby Atmos. Fit top front speakers on the ceiling forward of the seating position, top middle speakers on the ceiling directly above the seating position, and top rear speakers on the ceiling behind the seating position. The distance between each pair should match the distance between the two front speakers.

- Dolby Laboratories recommends placing this type of height speakers to obtain the best Dolby Atmos effect.
- "Speaker combinations" (P13) introduces some detailed examples of speaker combinations.

- 7,8 Height Speakers
- Choose one of the following:
- Top Front Speakers
 - Top Middle Speakers
 - Top Rear Speakers

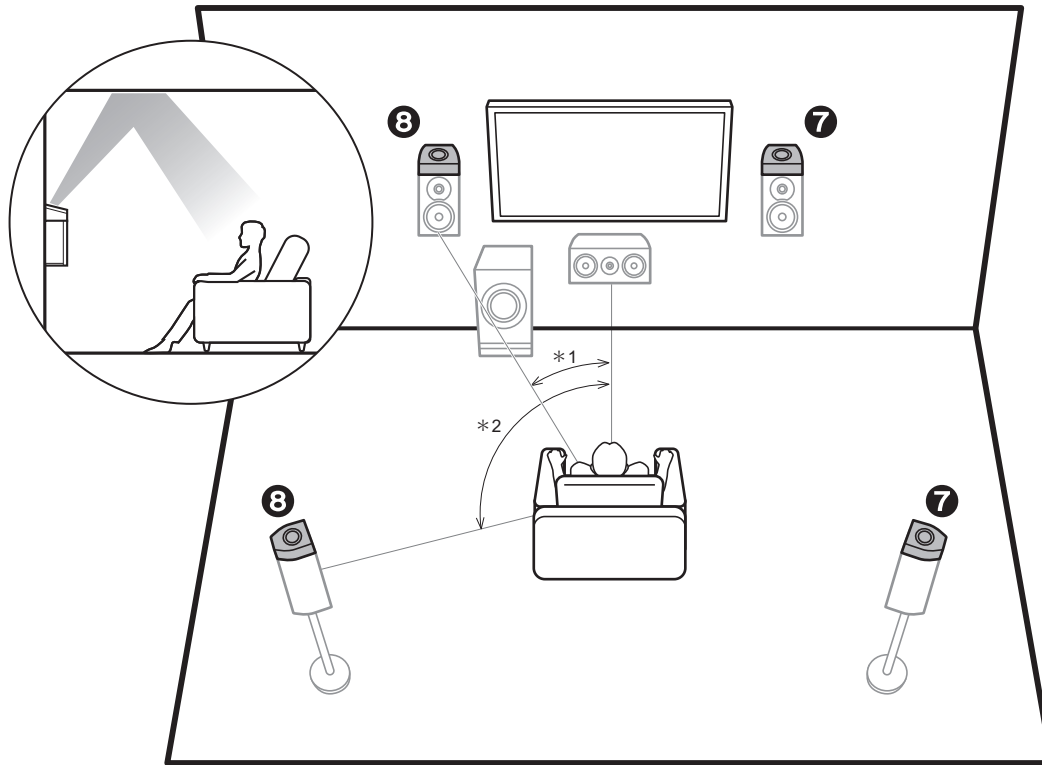

*1: 22° to 30°, *2: 120°

5.1.2 Channel System-3 (Dolby Enabled Speakers (Dolby Speakers))

This is a basic 5.1 channel system consisting of front speakers, a center speaker, surround speakers, and a powered subwoofer, with the addition of Dolby enabled speakers (front) or Dolby enabled speakers (surround), which are both types of height speakers. Dolby enabled speakers are special speakers designed to face the ceiling so that sound is heard after bouncing off the ceiling so that sound appears to be coming from overhead. By installing height speakers, you can select the Dolby Atmos listening mode, which realizes the most up-to-date 3D sound including overhead sounds, when the input format is Dolby Atmos.

Place them either above the front speakers or above the surround speakers.

- "Speaker combinations" (P13) introduces some detailed examples of speaker combinations.

7,8 Height Speakers

Choose one of the following:

- Dolby Enabled Speakers (Front)
- Dolby Enabled Speakers (Surround)

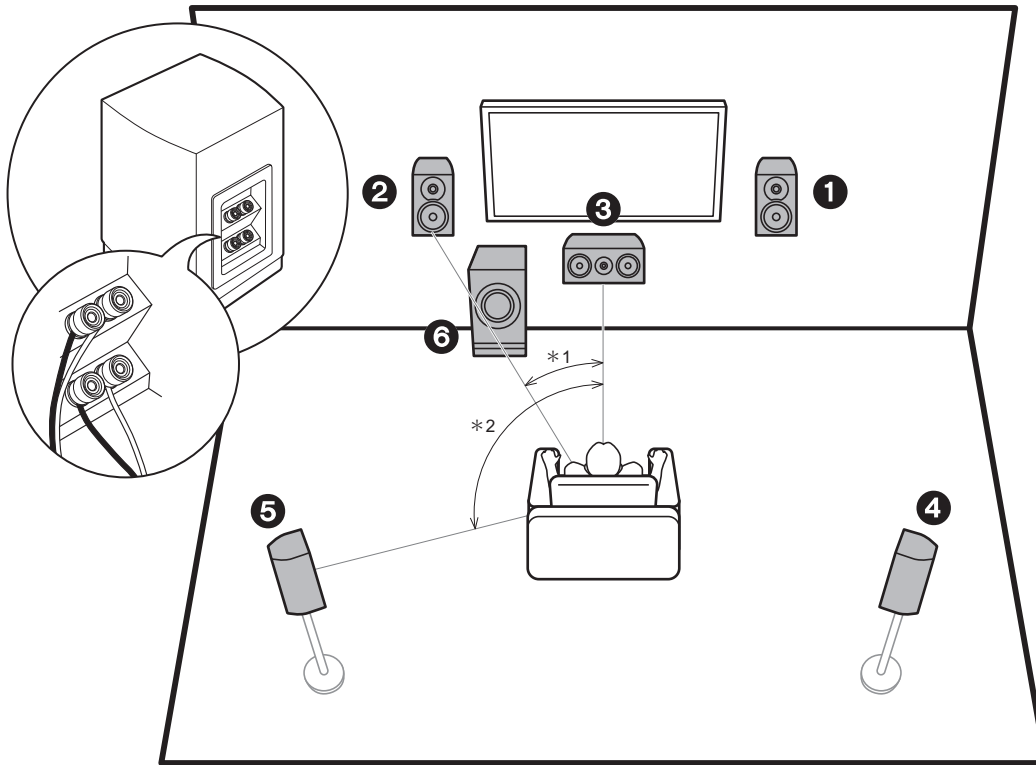

*1: 22° to 30°, *2: 120°

Bi-Amping the Speakers

With a 5.1 channel system, it is possible to connect front speakers that support Bi-Amping to improve the quality of the bass and treble. Bi-Amping compatible speakers need their terminals for the tweeters connected to one amplifier and their terminals for woofers connected to another amplifier, so it is not possible to connect height speakers and surround back speakers with this connection. Other than front speakers, you can also connect a center speaker, surround speakers, and a powered subwoofer.

- "Speaker combinations" (P13) introduces some detailed examples of speaker combinations.

- 1,2 Front Speakers (Bi-Amping)
- 3 Center Speaker
- 4,5 Surround Speakers
- 6 Powered Subwoofer

Speaker combinations

- In any of the combinations, up to two powered subwoofers can be connected.

Speaker Channels	FRONT	CENTER	SURROUND	SURROUND BACK	HEIGHT	Bi-AMP	ZONE 2 (ZONE SPEAKER) (P20)
2.1 ch	✓					✓ (*1)	✓ (*1)
3.1 ch	✓	✓				✓ (*1)	✓ (*1)
4.1 ch	✓		✓			✓ (*1)	✓ (*1)
5.1 ch	✓	✓	✓			✓ (*1)	✓ (*1)
6.1 ch	✓		✓	✓ (*2)			✓
7.1 ch	✓	✓	✓	✓ (*2)			✓
2.1.2 ch	✓				✓ (*3)		✓
3.1.2 ch	✓	✓			✓ (*3)		✓
4.1.2 ch	✓		✓		✓ (*3)		✓
5.1.2 ch	✓	✓	✓		✓ (*3)		✓

(*1) You can select Bi-AMP or ZONE SPEAKER.

(*2) No sound is played from the surround back speakers when playing audio from ZONE SPEAKER.

(*3) No sound is played from the height speakers when playing audio from ZONE SPEAKER.

Step2: Connect the Speakers

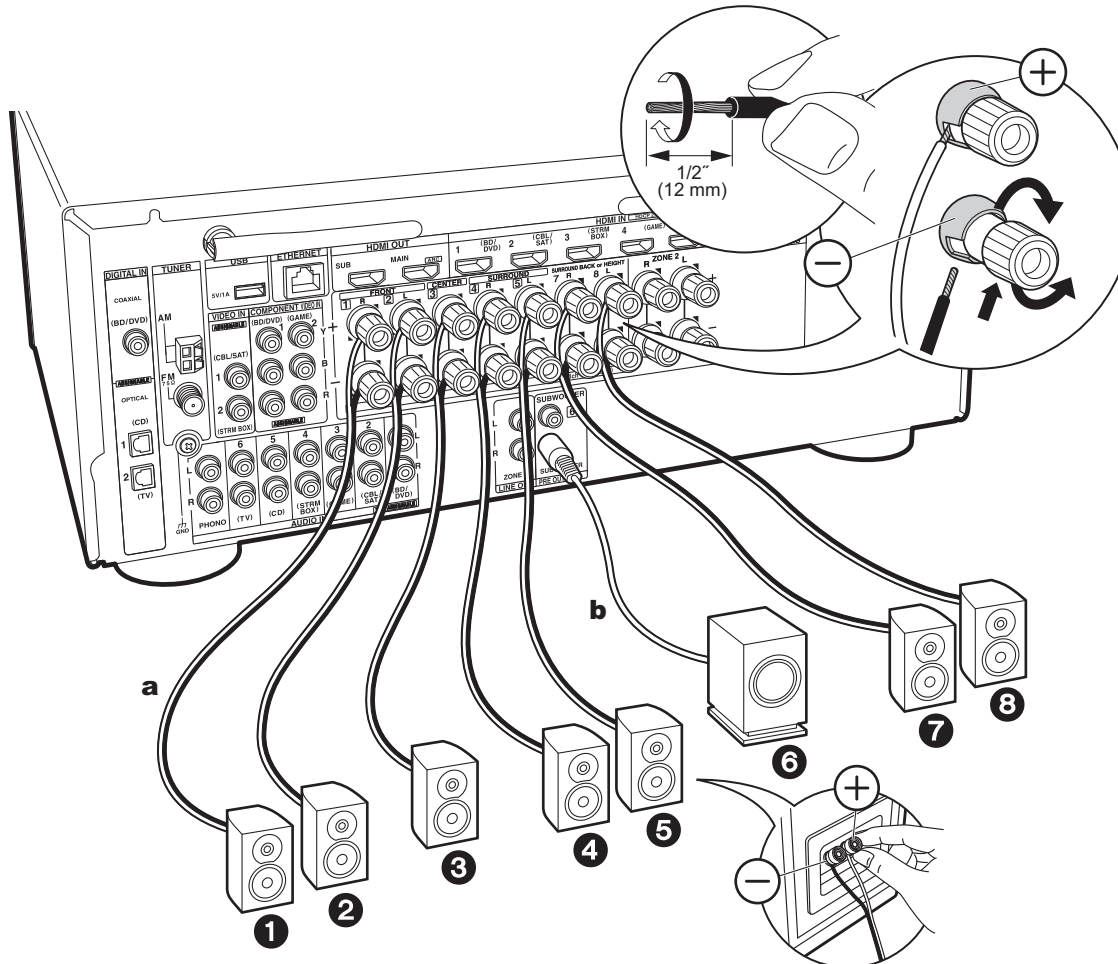

a Speaker cable, **b** Subwoofer cable

Standard Connections (Pages 8 to 11)

Up to two powered subwoofers can be connected. The same signal is output from each of the SUBWOOFER PRE OUT jacks.



Setup

- Settings for the speaker configuration you have connected need to be made in "1. AccuEQ Room Calibration" in Initial Setup (P22).
- If any of the connected speakers have an impedance of $4\ \Omega$ or more to less than $6\ \Omega$, after completing Initial Setup, you need to make some settings in the Setup menu. Press  on the remote controller, select "2. Speaker" - "Configuration" and set "Speaker Impedance" to "4ohms".

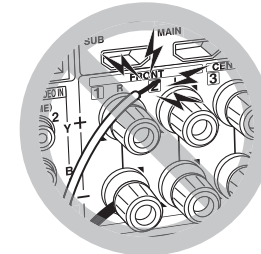

Make sure the exposed wires of the speakers do not stick out of the speaker terminals when connecting. If the exposed wires of the speakers touch the rear panel or the + and - wires touch each other, the protection circuit will be activated.

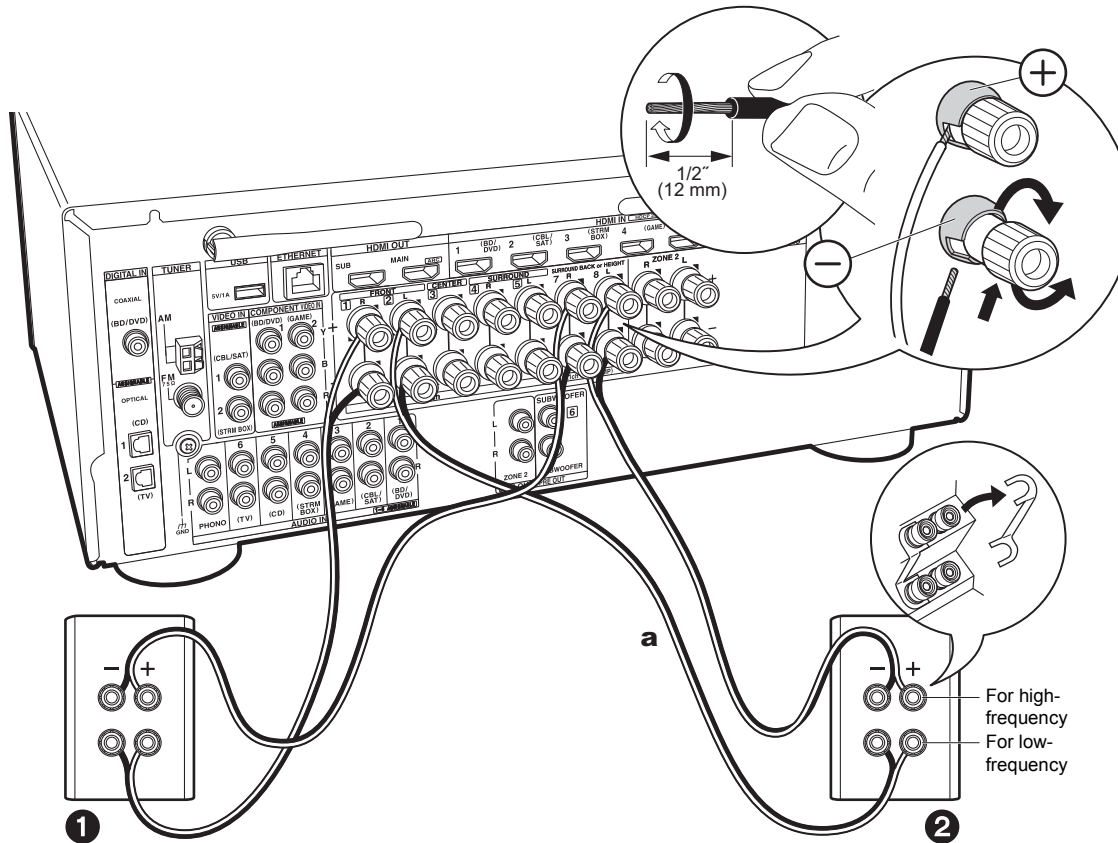

a Speaker cable

Connecting with Bi-Amping Speakers (Page 12)

Make sure you remove the jumper bar fitted between the woofer jacks and tweeter jacks of the front speakers. Refer to "Standard Connections (Pages 8 to 11)" (P14) to connect the center speaker, surround speakers, and powered subwoofer.

- Also refer to the instruction manual for your speakers when using connections for Bi-Amping.



Setup

- Settings for the speaker configuration you have connected need to be made in "1. AccuEQ Room Calibration" in Initial Setup (P22).
- If any of the connected speakers have an impedance of 4 Ω or more to less than 6 Ω, after completing Initial Setup, you need to make some settings in the Setup menu. Press ⚙ on the remote controller, select "2. Speaker" - "Configuration" and set "Speaker Impedance" to "4ohms".

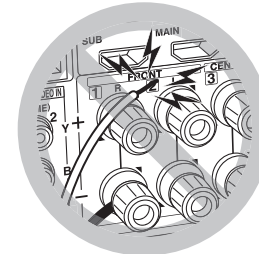

Make sure the exposed wires of the speakers do not stick out of the speaker terminals when connecting. If the exposed wires of the speakers touch the rear panel or the + and - wires touch each other, the protection circuit will be activated.

Step3: Connect the TV & AV Components

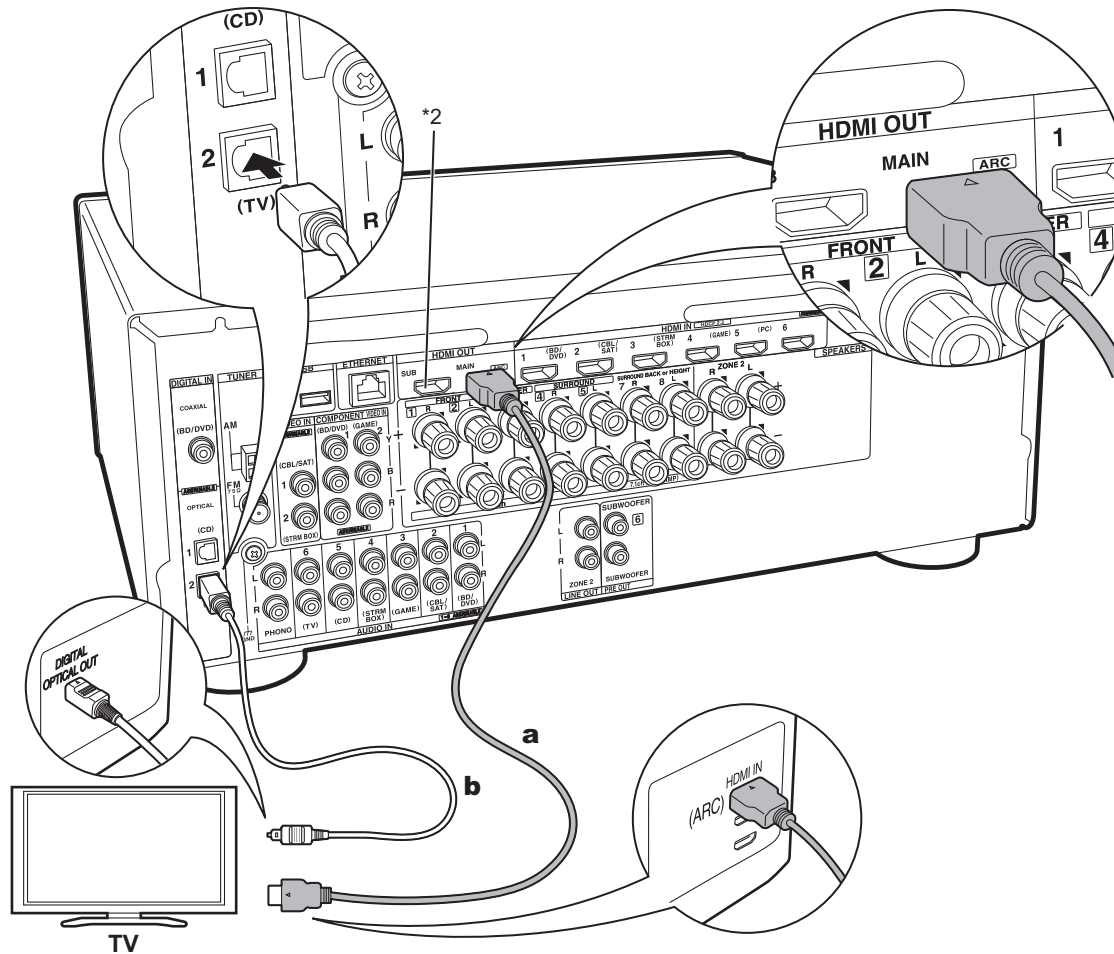

a HDMI cable, **b** Digital optical cable

1. Connect the TV

To ARC TV

For a TV that supports the ARC (Audio Return Channel) (*1) feature, use an HDMI cable and connect according to illustration "a". Choose an HDMI IN jack on the TV that supports ARC when connecting.



Setup

- Settings are required to use the ARC function. Select "Yes" in "5. Audio Return Channel" (P23) in the Initial Setup.
- Refer to the instruction manual for the TV for TV connections and instructions regarding settings for CEC features and audio output.

To Non-ARC TV

For a TV that does not support the ARC (Audio Return Channel) feature (*1), connect both the HDMI cable in illustration "a" and the digital optical cable in "b".

- Connection with a digital optical cable is not necessary if you will watch TV through a device such as a cable set-top box (that is, not use a tuner built into the TV) that you have connected to the input jack on this unit.

(*1) The ARC feature: This feature transfers TV audio signals via HDMI cable so that you can play the audio from the TV through this unit. Connection to an ARC compatible TV is complete with one HDMI cable. Refer to the instruction manual for your TV to see if it supports ARC.

(*2) Another TV or projector can be connected to the HDMI OUT SUB jack. Press Q (P6) on the remote control and use "Other" - "HDMI Out" to switch between MAIN and SUB. Note that this jack does not support ARC.

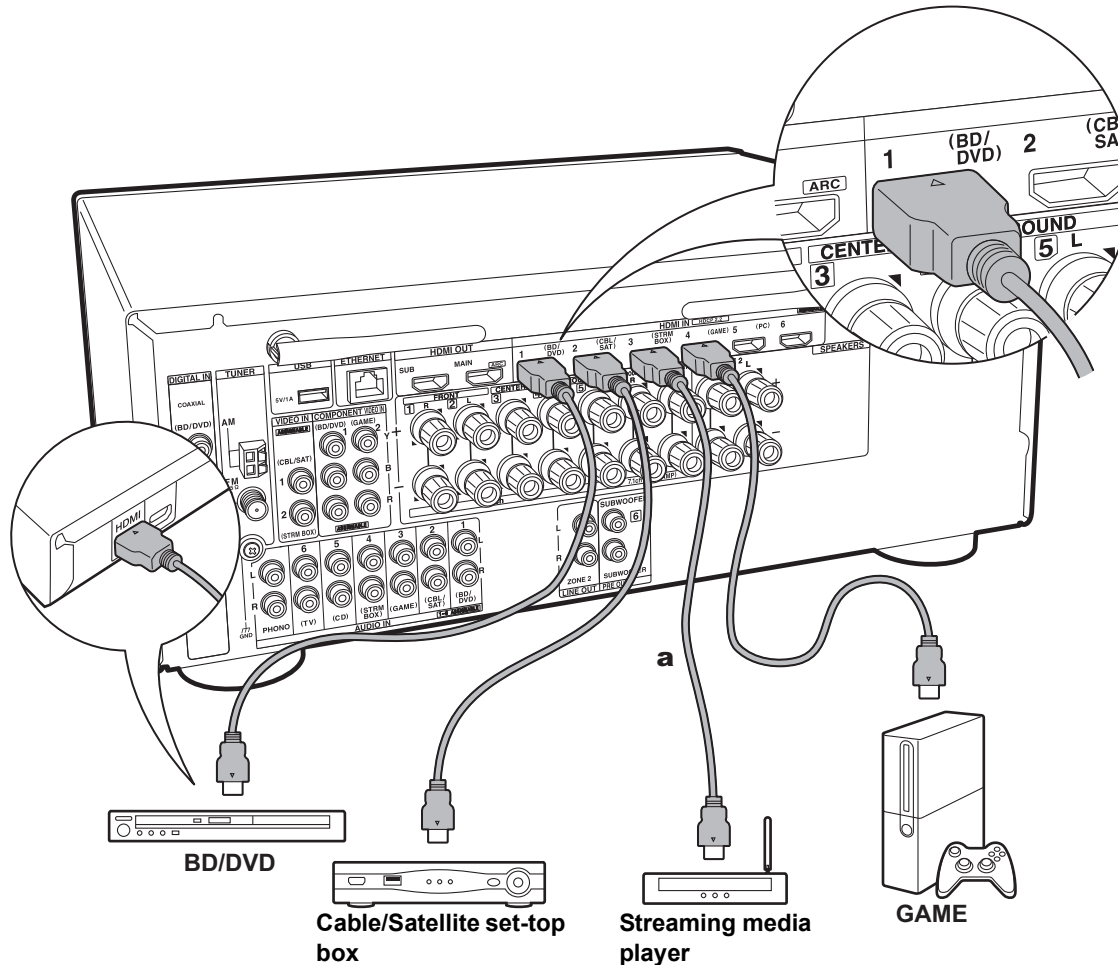

a HDMI cable

2. Connect the HDMI AV Component

This is an example of connection with an AV component that has an HDMI jack. With connection to an AV component that conforms with the CEC (Consumer Electronics Control) standard, you can use features such as the HDMI CEC feature (*) that links with the input selector, and the HDMI Standby Through feature which allows you to play video and audio from AV components on the TV even when this unit is in standby mode.

- To play 4K or 1080p video, use a high speed HDMI cable.



Setup

- When "Yes" is selected for "5. Audio Return Channel" in Initial Setup (P23), the HDMI CEC function and HDMI Standby Through function are automatically enabled. If "No, Skip" is selected, settings are required in the Setup menu after Initial Setup is complete. Press ⚙ on the remote controller and make the settings in "5. Hardware" - "HDMI".
- To enjoy digital surround sound including Dolby Digital, audio output should be set to "Bitstream output" on the connected Blu-ray Disc player or other device.

(*)The HDMI CEC feature: You can control features such as linking input switching with the input selector and players conforming to the CEC standard, switching audio to output it from the TV or from this unit, and adjusting the volume using the remote controller of a CEC-compliant TV, and automatically switching this unit to standby when the TV is turned off.

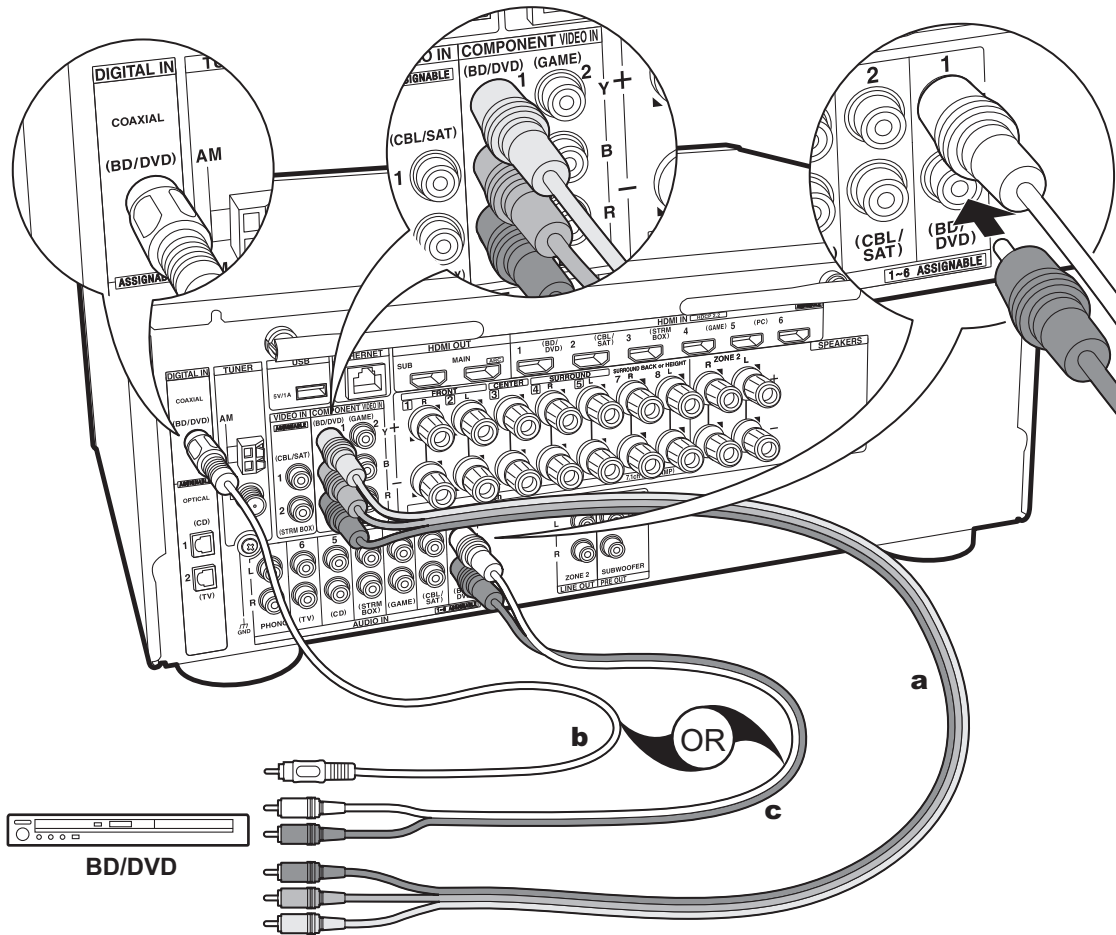

a Component video cable, **b** Digital coaxial cable, **c** Analog audio cable

3. Connect the Non-HDMI AV Component

This is an example of connection with an AV component that does not have an HDMI jack. Make the connections to the AV component to match the jacks it has. When video input connection is to the BD/DVD jack, the audio input connection should also be to the BD/DVD jacks, and so on, so that you connect the video input jacks to the jacks with the same name as the audio input jacks.

Note that video signals input to the VIDEO IN jack or the COMPONENT VIDEO IN jack will be converted to HDMI video signals and then output from the HDMI OUT jack.

- To enjoy digital surround playback in formats such as Dolby Digital, you need to make a connection for audio signals with a digital coaxial cable or a digital optical cable.
- It is possible to change assignment of the input jacks you see in the illustration at left, so you can also connect to any jack other than BD/DVD. For details, see the Advanced Manual.

Setup

- The COMPONENT VIDEO IN jacks are compatible only with 480i or 576i resolution. When you connect to the COMPONENT VIDEO IN jacks, set the output resolution of the player to 480i or 576i. Select interlace if there is no option for 480i, etc. If your player does not support 480i or 576i output, use the VIDEO IN jack.
- To enjoy digital surround sound including Dolby Digital, audio output should be set to "Bitstream output" on the connected Blu-ray Disc player or other device.

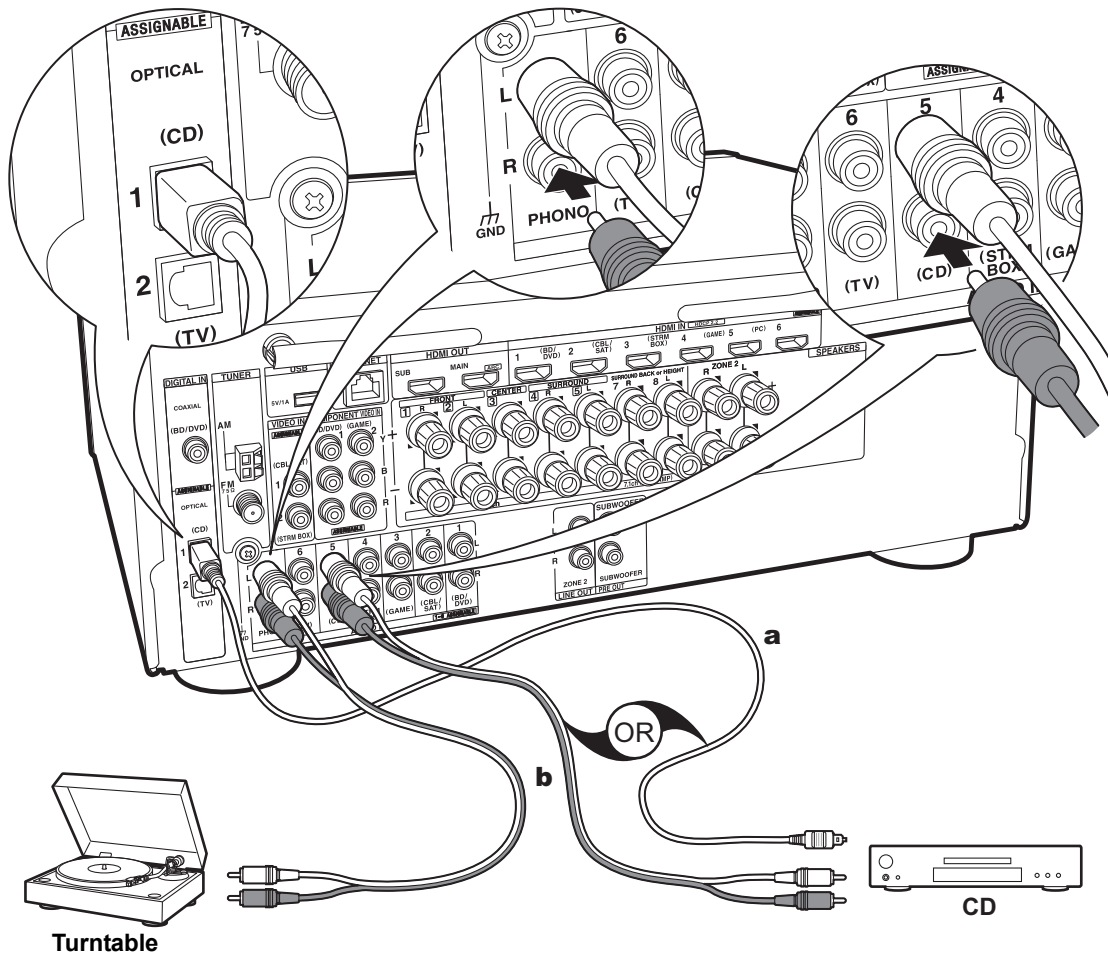

a Digital optical cable, **b** Analog audio cable

4. Connect the Audio Component

Example of a connection with an audio component. Connect a CD player using a digital optical cable or analog audio cable. You can also connect a turntable that has an MM-type cartridge to the PHONO jack.

- If the turntable has a built-in audio equalizer, connect it to another AUDIO IN jack. Further, if the turntable uses an MC type cartridge, install an audio equalizer compatible with the MC type cartridge between the unit and the turntable, then connect to any AUDIO IN jack other than the PHONO jack.

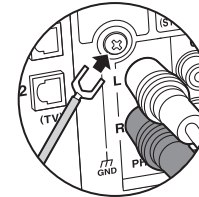

If the turntable has a ground wire, connect it to the GND terminal of this unit.

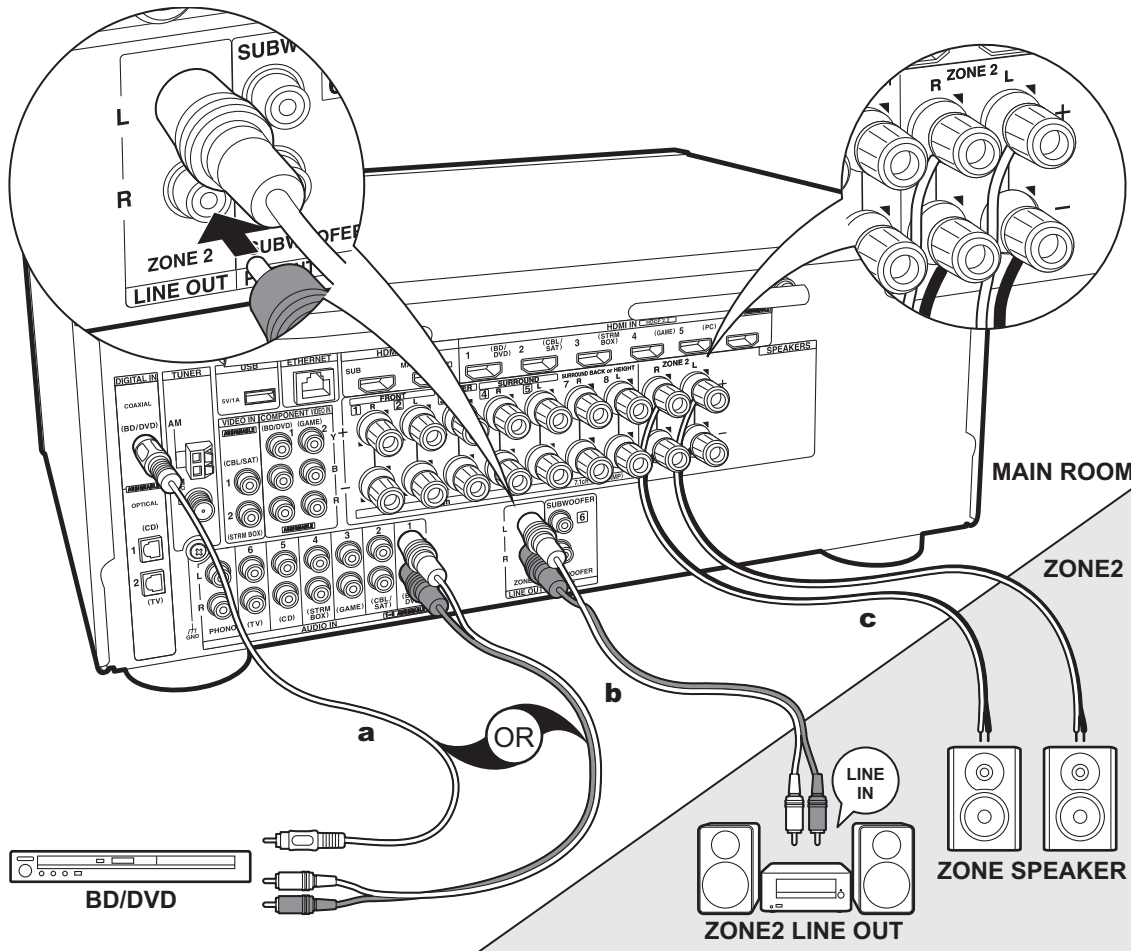

a Digital coaxial cable, **b** Analog audio cable, **c** Speaker cable

5. Multi-zone Connection

You can enjoy audio in the separate room by, for example, playing a Blu-ray Disc player in the main room (where this unit is located) and listening to internet radio in the separate room (ZONE 2).

- DSD and Dolby TrueHD audio signals are not output to ZONE 2 when selected with the "NET" input selector.

Connections with an AV component

When outputting the audio of an externally connected AV component to ZONE 2, you need to connect using a digital coaxial cable, digital optical cable, or analog audio cable.

ZONE 2 LINE OUT

It is possible to play 2 ch source in a separate room while 7.1 ch source is being played in the main room. Connect the ZONE 2 LINE OUT jacks of the unit and the LINE IN jacks of the pre-main amplifier in a separate room with an analog audio cable.

ZONE SPEAKER

It is possible to connect speakers in a separate room and play 2 ch sources.

- You cannot use ZONE SPEAKER if you have connected the front speakers using Bi-Amping connection.
- No sound is played from the surround back speakers or the height speakers when playing audio from ZONE 2 SPEAKER.



Setup

- Settings are required in Initial Setup, "4. Multi Zone Setup" (P23) to enjoy this feature.
- The audio from externally connected AV components can only be played in ZONE 2 when the audio is analog or 2ch PCM audio. If you have connected to this unit with a digital coaxial cable or digital optical cable, it may be necessary to change the audio output of the AV component to PCM output.

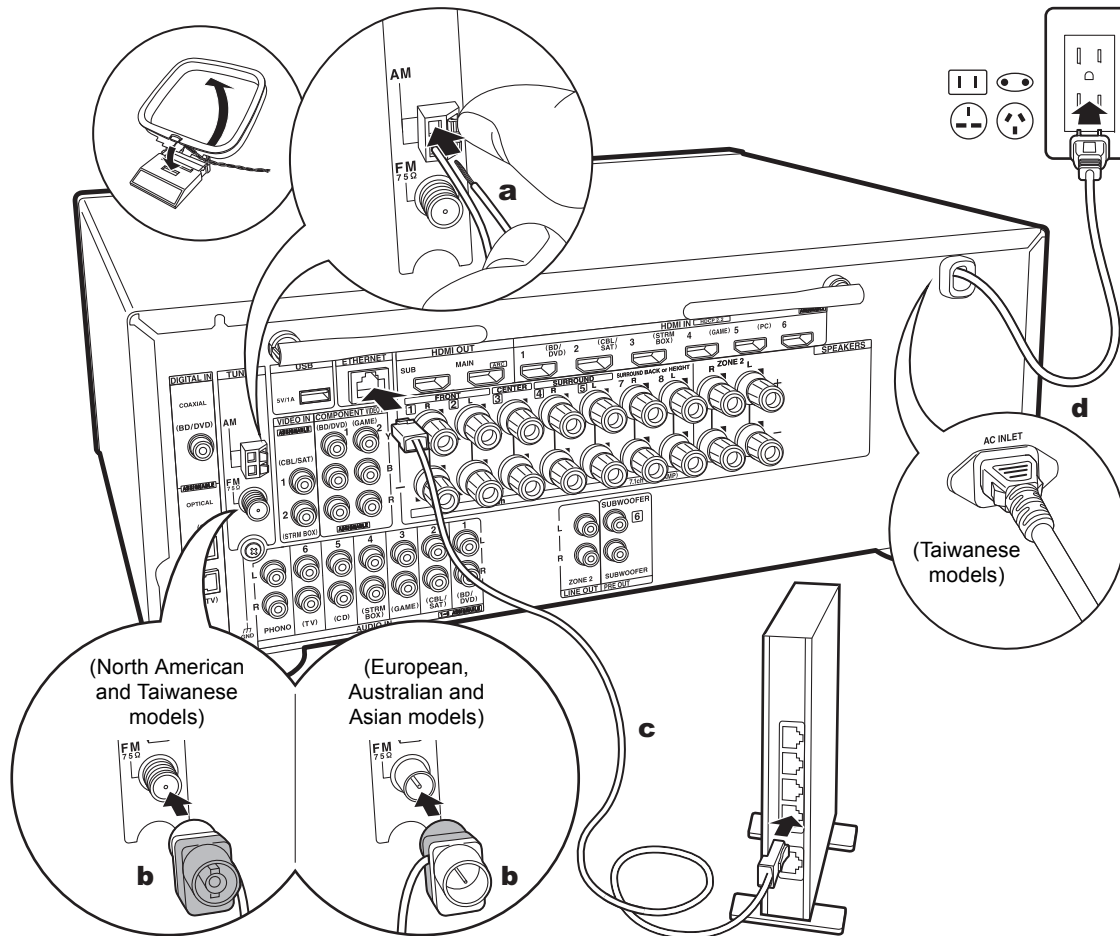

a AM loop antenna, **b** Indoor FM antenna, **c** Ethernet cable, **d** Power cord

6. Connect Other Cables

Antenna Hookup

Move the antenna around while playing the radio to find the position with the best reception. Use a thumb tack or similar to attach the indoor FM antenna to a wall.

Network Hookup

Connect this unit to the network using wired LAN or Wi-Fi (wireless LAN). You can enjoy network features such as internet radio by connecting the unit to the network. If you connect by wired LAN, connect with an Ethernet cable to the ETHERNET port as shown in the illustration. To connect by Wi-Fi, then after selecting "Wireless" in "3. Network Connection" (P23) in Initial Setup, select the desired setting method and follow the onscreen instructions to configure the connection.

Power Cord Hookup

The power cord must be connected only after all other cable connections are completed.

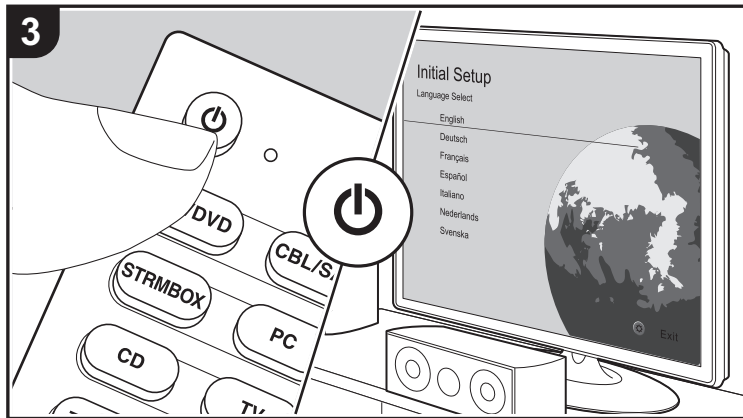
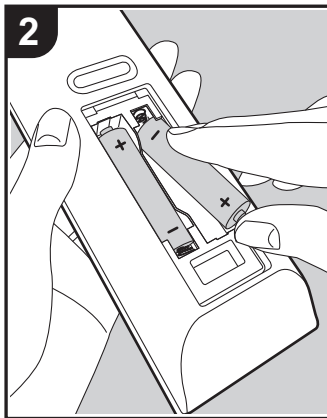
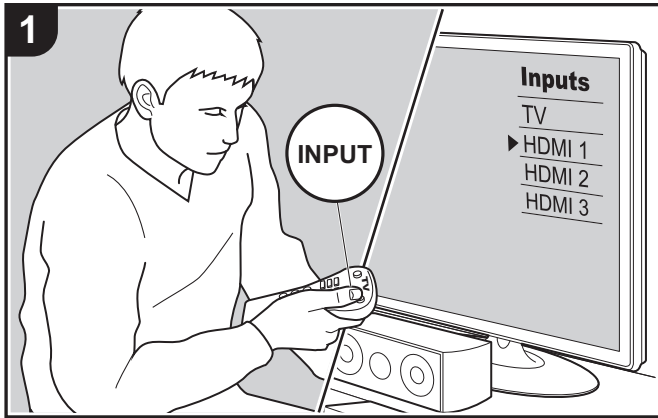

- Taiwanese models include removable power cords. Connect the power cord to AC INLET of the unit and then connect to the outlet. Always disconnect the outlet side first when disconnecting the power cord.

Initial Setup with Auto Start-up Wizard



Initial Setup Starts Automatically

When you turn the unit on for the first time after purchasing it, Initial Setup is automatically shown on the TV to enable you to make settings required for startup using simple operations following onscreen guidance.

1. Switch the input on the TV to that assigned to the unit.
2. Put batteries into the remote controller of this unit.
3. Press  on the remote controller to turn the unit on.
4. Select the item with the cursors of the remote controller and press ENTER (a) to confirm your selection. To return to the previous screen, press  (b).

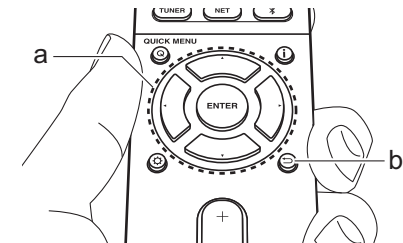

- If you terminate the procedure on the way or want to change a setting made during Initial Setup, press  on the remote controller, select "7. Miscellaneous" – "Initial Setup", and press ENTER.

■ 1. AccuEQ Room Calibration

Place the supplied speaker setup microphone in the listening position, measure the test tones emitted by the speakers, then the unit automatically sets the optimum volume level for each speaker, the crossover frequencies, and the distance from the listening position. This also automatically adjusts the equalizers for the speakers and enables correction of distortion caused by the acoustic environment of the room.

- Calibration takes between 3 and 12 minutes to be completed.

The speakers emit the test tone at high volume during measurement, so be careful of your surroundings. Keep the room as quiet as possible during measurement.

- If you have connected a subwoofer, check the power and volume of the subwoofer. Set the subwoofer volume to more than halfway.
 - If the power of this unit suddenly turns off, the wires in the speaker cables may have touch the rear panel or other wires and tripped the protection circuit. Twist the wires again properly and make sure they do not stick out of the speaker terminals when connecting.
1. Place the supplied speaker setup microphone in the listening position, and connect to the SETUP MIC jack on the main unit.

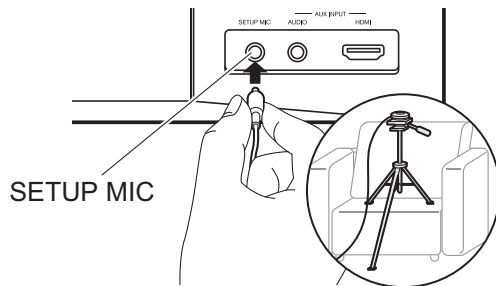

When putting the speaker setup microphone on a tripod, refer to the illustration when putting it in place.

2. Select the connected speaker configuration.

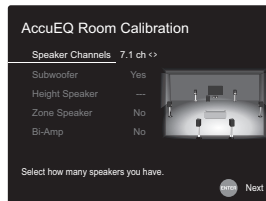

The image on the screen changes as you choose the number of channels in "Speaker Channels", so refer to it when performing the settings.

3. Test tones are emitted by the speakers, and firstly the unit detects the speakers connected and the noise in the environment.
4. After the results of the above measurements are displayed, select "Next", press ENTER on the remote controller, and the test tones are emitted again, and the unit automatically makes settings such as the optimum volume level and the crossover frequency.
5. When the measurement is completed, the measurement result is displayed. Press the cursors ◀ / ▶ on the remote controller to check the settings. Press ENTER when "Save" is selected to save the settings.
6. Select whether to enable or disable the equalizer function that corrects for distortion caused by the acoustic environment of the room. If this is to be enabled, then normally you should select "On (All Channels)", and to disable just the front speakers you should select "On (Except Front Left / Right)".
7. Disconnect the speaker setup microphone.

■ 2. Source Connection

Check that each input source is connected correctly. Follow the guidance, select the input you want to confirm, start play of the selected player, and confirm that the images appear on the TV and that sound is played.

■ 3. Network Connection

Set up Wi-Fi connection with an access point such as a wireless LAN router. There are the following two methods of connecting by Wi-Fi:

"Scan Networks": Search for an access point from this unit. Find out the SSID of the access point beforehand.

"Use iOS Device (iOS7 or later)": Share the iOS device's Wi-Fi settings with this unit.

If you select "Scan Networks", there are a further two choices of connection method. Check the following.

"Enter Password": Enter the password (or key) of the access point to connect.

"Push Button": If the access point has an automatic connection button, you can connect without entering a password.

- If the SSID of the access point is not displayed, then in the screen listing the SSIDs, select "Other..." with the ► cursor on the remote controller and press ENTER, then follow the onscreen instructions.

Keyboard Input

To switch between upper and lower case, select "A/a" on the screen and press ENTER. To select whether to mask the password with "*" or display it in plain text, press MEMORY on the remote controller. Press CLEAR to delete all the input characters.

- A confirmation screen asking you to agree to the privacy policy is displayed during network setting. Select "Accept" and press ENTER to indicate agreement.

■ 4. Multi Zone Setup

When you want to enjoy audio in a room other than the main room, set the audio output method for the separate room (ZONE 2). If you have connected speakers in a separate room with speaker cable, select "Using AV Receiver". If you have connected a pre-main amplifier in a separate room with an analog audio cable, select "with External Premain Amplifier".

■ 5. Audio Return Channel

If you have connected a TV that supports ARC, select "Yes". This unit's ARC setting turns on and you can listen to the TV's audio through this unit.

AV Component Playback

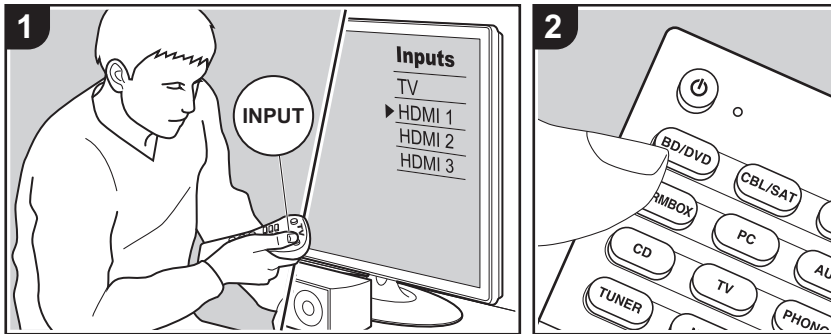

Basic Operations

You can play the audio from AV components such as Blu-ray Disc players through this unit.

- When a TV is connected to the HDMI OUT SUB jack, press Q (P6) on the remote controller and use "Other" - "HDMI Out" to switch between MAIN and SUB.

Perform the following procedure when the unit is on.

1. Switch the input on the TV to that assigned to the unit.
2. Press the input selector (a) on the remote controller with the same name as the jack to which you connected the player to switch the input.
For example, press BD/DVD to play the player connected to the BD/DVD jack. Press TV to listen the TV's sound. To play a device connected to the AUX INPUT AUDIO/HDMI jack on the front panel, press AUX.

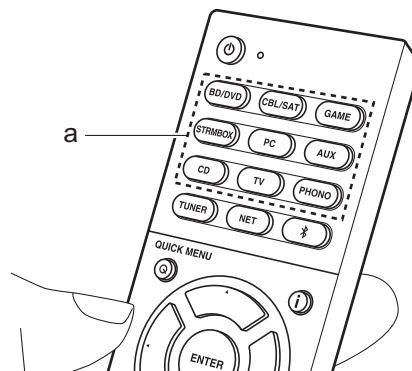

- When the CEC link function works, the input switches automatically when you have connected a CEC compliant TV and player to this unit using HDMI connection.
3. Start play on the AV component.

BLUETOOTH® Playback

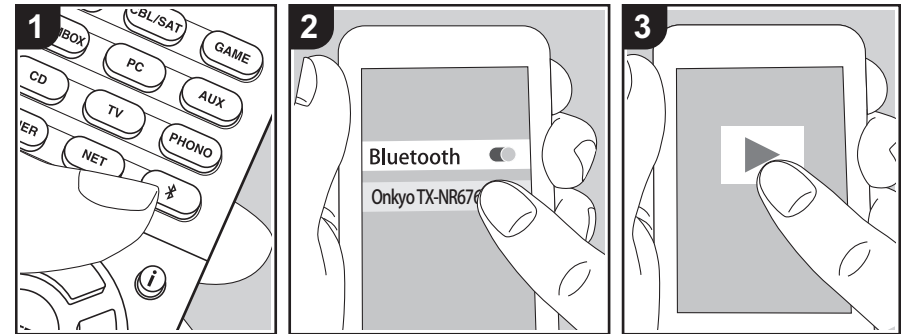

You can wirelessly play music on a smartphone or other BLUETOOTH wireless technology enabled device. Perform the following procedure when the unit is on.

Pairing

1. When you press the Bluetooth button, "Now Pairing..." is displayed on this unit's display, and the pairing mode is enabled.

Now Pairing...

2. Enable (turn on) the BLUETOOTH function of the BLUETOOTH wireless technology enabled device, then select this unit from amongst the devices displayed. If a password is requested, enter "0000".
 - This unit is displayed as "Onkyo TX-NR676 (or 676E) XXXXXX".
 - To connect another BLUETOOTH wireless technology enabled device,

press and hold Bluetooth until "Now Pairing..." is displayed, then perform step 2. This unit can store the data of up to 8 paired devices.

- The coverage area is 48'/15 m. Note that connection is not always guaranteed with all BLUETOOTH wireless technology enabled devices.

Playing Back

1. Perform the connection procedure on the BLUETOOTH wireless technology enabled device.
The input on this unit automatically switches to "BLUETOOTH".
2. Play music. Increase the volume of the BLUETOOTH wireless technology enabled device to an appropriate level.
 - Due to the characteristics of BLUETOOTH wireless technology, the sound produced on this unit may slightly be behind the sound played on the BLUETOOTH wireless technology enabled device.

Network Functions

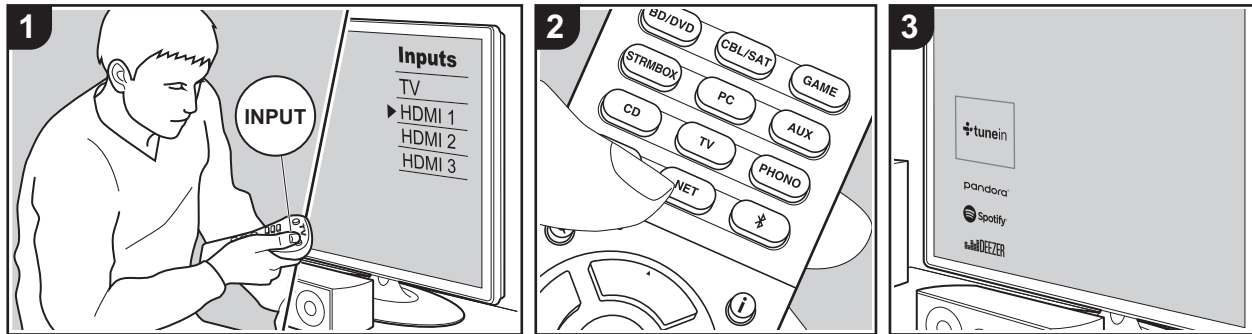

Basic Operations

By connecting this unit to the network you can enjoy internet radio services such as TuneIn, streaming from Spotify Connect, and wireless playback using AirPlay® features. Furthermore, you can use the Music Server feature to stream music files stored on PCs or NAS devices that support the home network feature. The basic operations for Network Functions are introduced in the Basic Manual. For more advanced operations, see the Advanced Manual. There may also be additional network functions provided through firmware updates for this unit. Also see the Advanced Manual for information about new features.

- The network needs to be connected to the internet in order to play internet radio services.
- Depending on the internet radio service, the user may need to register from their computer first.
- To enable Spotify Connect, install the

Spotify application on your smartphone or tablet and create a Spotify premium account.

– Refer to the following for Spotify settings:

www.spotify.com/connect/

- The network servers compatible with the Music Server feature are those PCs with players installed that have the server functionality of Windows Media® Player 11 or 12, or NAS that are compatible with home network functionality. Note that with PCs, only music files registered in the library of Windows Media® Player can be played.
- You may need to make some settings on the PC in advance to use Windows Media® Player 11 or 12 with the Music Server feature.

Perform the following procedure when the unit is on.

1. Switch the input on the TV to that assigned to the unit.
2. Press NET (a) on the remote controller

to display a list of Network Functions on the TV.

3. Select the Network Function with the cursors of the remote controller and press ENTER (b) to confirm your selection.

With internet radio services, follow the on-screen instructions, using the cursors to select radio stations and programs, then press ENTER to play. With Spotify or AirPlay, select this unit with your smartphone to play. With Music Server, select the server with the cursors, then select the desired music file and press ENTER to play.

- To return to the previous screen, press ↶ (c).

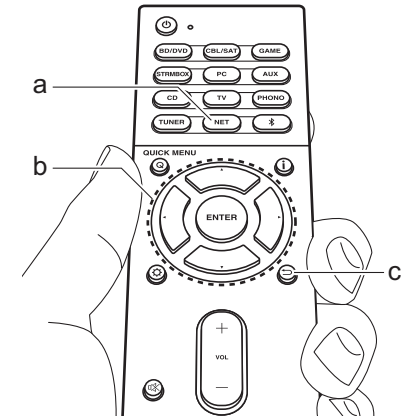

USB Storage Device

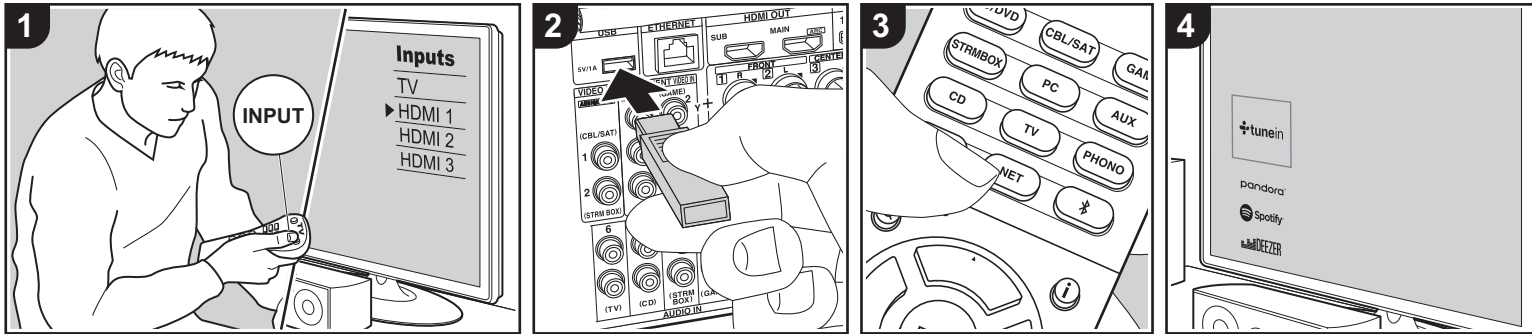

Basic Operations

You can play music files stored on a USB storage device.

Perform the following procedure when the unit is on.

1. Switch the input on the TV to that assigned to the unit.
2. Plug your USB storage device with the music files into the USB port of this unit's rear panel.
3. Press NET (a) on the remote controller to display the network service list screen.
4. With the cursors on the remote controller, select "USB", and then press ENTER (b).
 - If the "USB" indicator flashes on the display, check whether the USB storage device is plugged in properly.
 - Do not unplug the USB storage device while "Connecting..." is appeared on the display. This may cause data corruption or malfunction.

5. Press ENTER on the remote controller again in the next screen. The list of folders and music files on the USB storage device are displayed. Select the folder with the cursors and press ENTER to confirm your selection.
6. With the cursors on the remote controller, select the music file, and then press ENTER to start playback.
 - To return to the previous screen, press ⏪ (c).
 - The USB port of this unit conforms with the USB 2.0 standard. The transfer speed may be insufficient for some content you play, which may cause some interruption in sound.
 - Operation cannot be guaranteed for all USB storage devices.
 - This unit can use USB storage devices that comply with the USB mass storage class standard. The unit is also compatible with USB storage devices using the FAT16 or FAT32 file system formats.

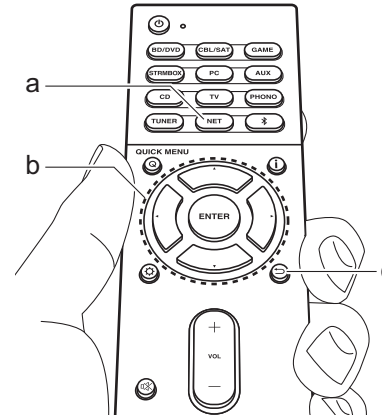

Listening to the AM/FM Radio

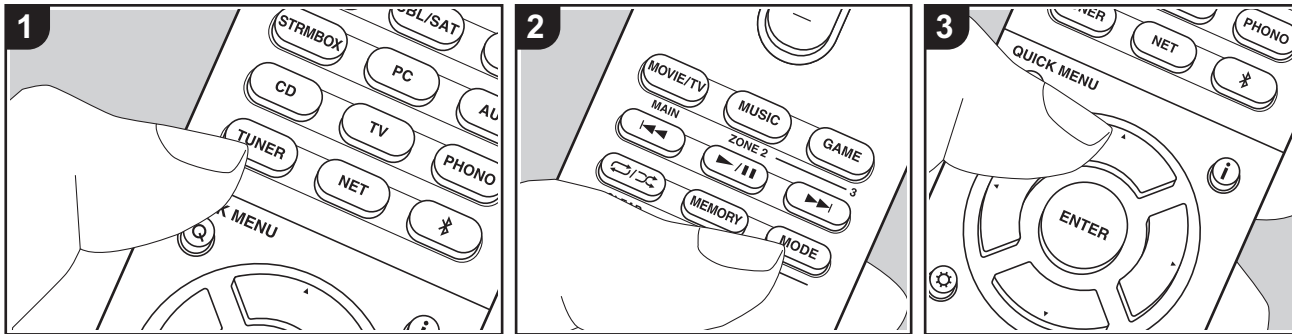

You can receive AM and FM radio stations on this unit with the built-in tuner. Perform the following procedure when the unit is on.

■ Tuning into a Radio Station

Tuning Automatically

1. Press TUNER (a) on the remote controller repeatedly to select either "AM" or "FM" on the display.
2. Press MODE (e) on the remote controller, so that the "TunMode: Auto" is displayed on the display.

TunMode: Auto

3. When you press the cursors ▲ / ▼ buttons (b) on the remote controller, automatic tuning starts, and searching stops when a station is found. When tuned into a radio station, the "TUNED" indicator on the display lights. When tuned into an FM stereo station, the "FM

ST" indicator lights.

When FM broadcasts reception is poor:

Perform the procedure for "Tuning Manually" in the following section. Note that if you tune manually, the reception for FM broadcasts will be monaural rather than stereo, irrespective of the sensitivity of the reception.

Tuning Manually

Note that if you tune manually, the reception for FM broadcasts will be monaural rather than stereo, irrespective of the sensitivity of the reception.

1. Press TUNER (a) on the remote controller repeatedly to select either "AM" or "FM" on the display.
2. Press MODE (e) on the remote controller, so that the "TunMode: Manual" is displayed on the display.

TunMode: Manual

3. While pressing the cursors ▲ / ▼ (b) on the remote controller, select the desired radio station.
 - The frequency changes by 1 step each time you press the cursors ▲ / ▼. The frequency changes continuously if the button is held down and stops when the button is released.

Frequency step setting:

Press the button, the cursor buttons and ENTER on the remote controller to select "7. Miscellaneous" – "Tuner" – "AM/FM Frequency Step" or "AM Frequency Step" and select the frequency step for your area. For Taiwanese models, the setting is "10 kHz / 0.2 MHz" at the time of purchase. Please change it to "9 kHz / 0.05 MHz". Note that when this setting is changed, all radio presets are deleted.

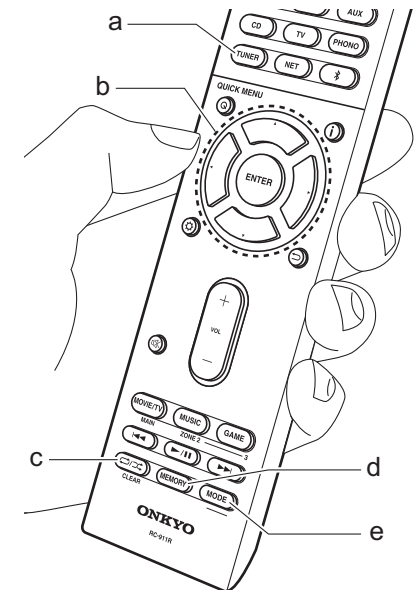

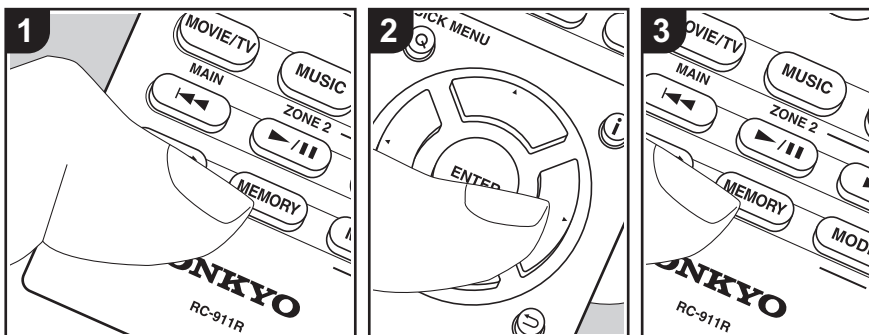

■ Presetting a Radio Station

You can preset up to 40 stations.

Registration Procedure

After tuning into the AM/FM radio station you want to register, perform the following procedure.

1. Press MEMORY (d) on the remote controller so that the preset number on the display flashes.

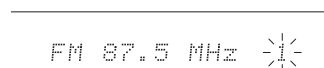

2. While the preset number is flashing (about 8 seconds), repeatedly press the cursors ◀ / ▶ (b) on the remote controller to select a number between 1 and 40.
3. Press MEMORY again on the remote controller to register the station. When registered, the preset number stops flashing. Repeat this procedure for all of your favorite AM/FM radio stations.

Selecting a Preset Radio Station

1. Press TUNER (a) on the remote controller.
2. Press cursors ◀ / ▶ (b) on the remote controller to select a preset number.

Deleting a Preset Radio Station

1. Press TUNER (a) on the remote controller.
2. Press cursors ◀ / ▶ (b) on the remote controller to select the preset number to delete.
3. After pressing MEMORY (d) on the remote controller, press CLEAR (c) while the preset number is flashing to delete the preset number. When deleted, the number on the display goes off.

■ Using RDS (European, Australian and Asian models)

RDS stands for Radio Data System and is a method of transmitting data in FM radio signals. In regions using RDS, the radio station name is displayed when you tune into a radio station broadcasting program information. When you press **i** on the remote controller in this state, you can use the following functions.

Display Text Information (Radio Text)

1. While the name of the station is being displayed on the display, press **i** on the remote controller once. Radio Text (RT) broadcast by the station is displayed scrolling across the display. "No Text Data" is displayed when no text information is available.

Search for Stations by Program Type

1. While the name of the station is being displayed on the display, press **i** on the remote controller twice.
2. Press ◀ / ▶ on the remote controller to select the Program Type you want to find, then press ENTER to start the search.
 - The Program Types displayed are as follows: None / News (News reports) / Affairs (Current affairs) / Info (Information) / Sport / Educate (Education) / Drama / Culture / Science (Science and technology) / Varied / Pop M (Pop music) / Rock M

(Rock music) / Easy M (Middle of the road music) / Light M (Light classics) / Classics (Serious classics) / Other M (Other music) / Weather / Finance / Children (Children's programmes) / Social (Social affairs) / Religion / Phone In / Travel / Leisure / Jazz (Jazz music) / Country (Country music) / Nation M (National music) / Oldies (Oldies music) / Folk M (Folk music) / Document (Documentary)

- The information displayed may sometimes not match the content being broadcast by the station.
3. When a station is found, the station flashes on the display. Press ENTER while this is happening to start receiving that station. If you don't press ENTER, the unit continues to search for another station.
 - If no stations are found, the message "Not Found" is displayed.
- Unusual characters may be displayed when the unit receives unsupported characters. However, this is not a malfunction. Also, if the signal from a station is weak, information may not be displayed.

Multi-zone

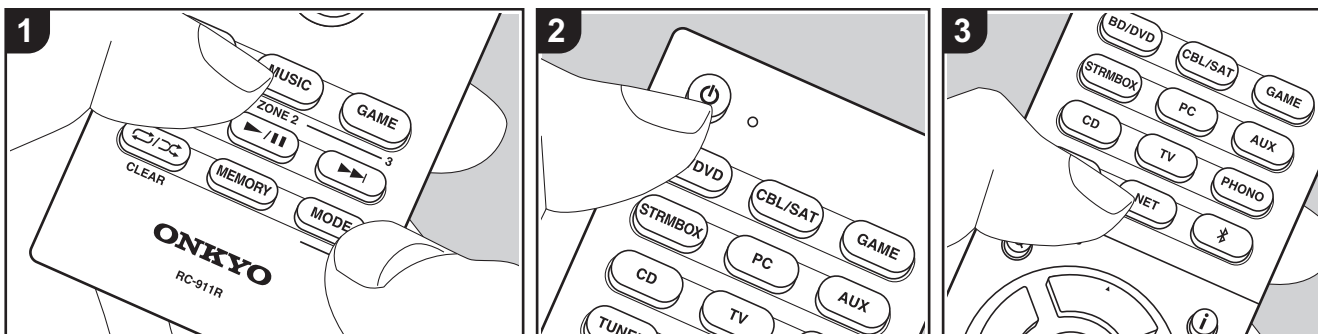

Basic Operations

You can enjoy audio in the separate room by, for example, playing a Blu-ray Disc player in the main room (where this unit is located) and listening to internet radio in the separate room (ZONE 2).

- DSD and Dolby TrueHD audio signals are not output to ZONE 2 when selected with the "NET" input selector.
- You can only select the same inputs for the main room and separate room with the "NET" or "BLUETOOTH" input selector. If you have "NET" selected in the main room and then select "BLUETOOTH" in the separate room, the main room also switches to "BLUETOOTH". You cannot select different stations for the main room and separate room with the AM/FM radio.
- If ZONE 2 is on, power consumption during standby becomes larger than normal.
- If ZONE 2 is turned on when the listening mode of the main room is Pure

Audio, it will automatically switch to the Direct listening mode. (European, Australian, Taiwanese and Asian models)

Perform the following procedure when the unit is on.

1. While holding down MODE (e) on the remote controller, press ZONE 2 (d) for 3 or more seconds until the remote indicator blinks twice.
 - The remote controller switches to the mode for controlling ZONE 2.
2. Point the remote controller at the main unit and press Z (a). "Z2" lights on the main unit display.



3. Press the input selector button (b) of the input to be played in the separate room.
 - On the main unit, after pressing ZONE 2, within 8 seconds press the input selector button to select the input to

be played in the separate room. To play the same source in the main room and separate room, press ZONE 2 on the main unit twice.

4. Volume adjustment is done on the pre-main amplifier for the separate room when connected via ZONE 2 LINE OUT. When outputting from ZONE speakers, adjust with volume buttons on the remote controller.
 - To control on the main unit, press ZONE 2 and adjust with the MASTER VOLUME control within 8 seconds.

To turn off the function:

Press Z while in the mode for controlling ZONE 2 on the remote controller. Alternatively press OFF on the main unit.

Playing in ZONE 2 only:

If you turn the unit to standby during multi-zone playback, the Z2 indicator is dimmed and the playback mode is switched to playback in a separate room only. Setting ZONE 2 to on while this unit is in standby

will also switch the playback mode to the same setting.

- i** **To return the remote controller to main room control mode:** While holding down MODE on the remote controller, press MAIN (c) for 3 seconds or more until the remote indicator flashes once.

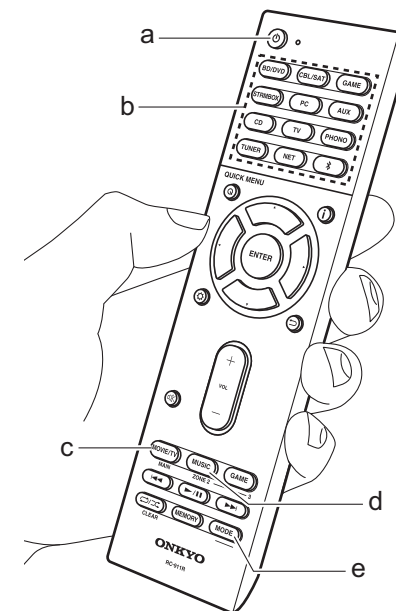

Listening Mode

This unit is equipped with a variety of listening modes, and you can select the optimum listening mode for movies, TV, music, and games using MOVIE/TV, MUSIC, and GAME (b). The basic operations are introduced in the Basic Manual. For more details, see the Advanced Manual.

- The listening mode last selected for the source is remembered for each of the MOVIE/TV, MUSIC, and GAME buttons. If content you play is not supported by the listening mode you selected last, the listening mode that is standard for that content is selected automatically.

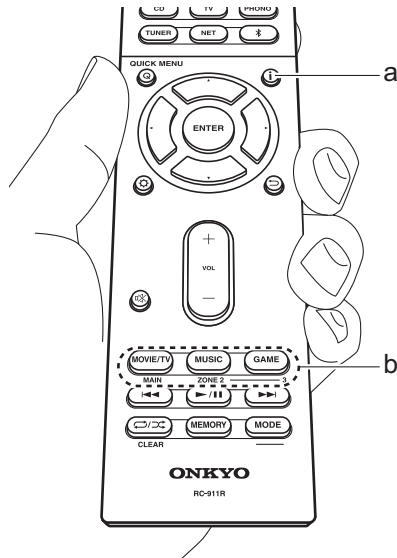

Dolby Digital/DTS Modes

When the input signal is a digital surround format such as Dolby Digital or DTS, you can select the listening mode that suits the input signal. Dolby Digital is displayed for Dolby Digital and DTS-HD Master Audio is displayed for DTS-HD Master Audio. The output is Stereo for 2-channel input signals.

Direct

This listening mode can be selected for all input signals. It shuts down processing that affects sound quality to deliver a playback sound quality closer to sources. Speakers play the sound field according to the number of channels in the input signal, so there would be output from only the front speakers for a 2 ch signal, for example.

Dolby Surround/DTS Neural:X

These listening modes allow you to expand the playback signal to 5.1 channels or 7.1 channels to suit the connected speaker configuration when the input signal is 2 channels or 5.1 channels.

Original Surround Modes

You can select listening modes such as the All Ch Stereo mode where a stereo image is played from both the front and the rear, and Orchestra (only with the MUSIC button) which is best for playback of classical and opera pieces.

Pure Audio (European, Australian, Taiwanese and Asian models)

Listening mode that provides purer sound quality by switching off the power of the display and analog video circuits. It can be selected with the MUSIC button and the button on the main unit.

Checking the Input Format and Listening Mode

Press **i** (a) on the remote controller several times to switch the display of the main unit as follows.

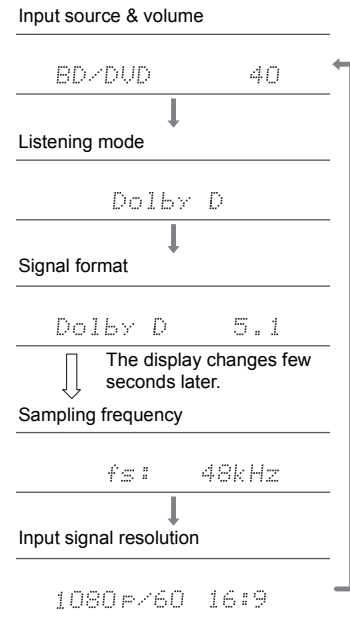

License and Trademark



Manufactured under license from Dolby Laboratories. Dolby, Dolby Atmos, Dolby Surround, Dolby Vision and the double-D symbol are trademarks of Dolby Laboratories.



For DTS patents, see <http://patents.dts.com>. Manufactured under license from DTS, Inc. DTS, the Symbol, DTS in combination with the Symbol, DTS:X, and the DTS:X logo are registered trademarks or trademarks of DTS, Inc. in the United States and/or other countries. © DTS, Inc. All Rights Reserved.



The terms HDMI and HDMI High-Definition Multimedia Interface, and the HDMI Logo are trademarks or registered trademarks of HDMI Licensing LLC in the United States and other countries.



The Wi-Fi CERTIFIED Logo is a certification mark of Wi-Fi Alliance®.



AirPlay, iPad, iPhone, iPod, iPod classic, iPod nano and iPod touch are trademarks of Apple Inc., registered in the U.S. and other countries.

iPad Air and iPad mini are trademarks of Apple Inc.

"Made for iPod", "Made for iPhone" and "Made for iPad" mean that an electronic accessory has been designed to connect specifically to iPod, iPhone, or iPad, respectively, and has been certified by the developer to meet Apple performance standards. Apple is not responsible for the operation of this device or its compliance with safety and regulatory standards.

Please note that the use of this accessory with iPod, iPhone or iPad may affect wireless performance.

AirPlay works with iPhone, iPad, and iPod touch with iOS 4.3.3 or later, Mac with OS X Mountain Lion or later, and PC with iTunes 10.2.2 or later.



PANDORA, the PANDORA logo, and the Pandora trade dress are trademarks or registered trademarks of Pandora Media, Inc. Used with permission.



The BLUETOOTH® word mark and logos are registered trademarks owned by Bluetooth SIG, Inc.

The Spotify software is subject to third party licenses found here: <https://developer.spotify.com/esdk-third-party-licenses/>

This product is protected by certain intellectual property rights of Microsoft. Use or distribution of such technology outside of this product is prohibited without a license from Microsoft.

Windows 7, Windows Media, and the Windows logo are trademarks or registered trademarks of Microsoft Corporation in the United States and/or other countries.

DSD and the Direct Stream Digital logo are trademarks of Sony Corporation.



Theater-Dimensional

"Theater-Dimensional" and "Theater-Dimensional (logo)" are trademarks of Onkyo Corporation.

"All other trademarks are the property of their respective owners."

"Toutes les autres marques commerciales sont la propriété de leurs détenteurs respectifs."

"El resto de marcas comerciales son propiedad de sus respectivos propietarios".

"Tutti gli altri marchi di fabbrica sono di proprietà dei rispettivi proprietari."

"Alle anderen Warenzeichen sind das Eigentum ihrer jeweiligen Eigentümer."

"Alle andere handelsmerken zijn eigendom van de desbetreffende rechthebbenden."

"Alla andra varumärken tillhör deras respektive ägare."

"Kaikki muut tuotemerkit ovat omistajien omaisuutta."

ONKYO

1-10-5 Yokoami, Sumida-ku, Tokyo 130-0015 JAPAN
<http://www.onkyo.com/>

<U.S.A.>

18 Park Way, Upper Saddle River, N.J. 07458, U.S.A.
For Dealer, Service, Order and all other Business Inquiries:
Tel: 201-785-2600 Fax: 201-785-2650
<http://www.us.onkyo.com/>

For Product Support Team Only:
1-800-229-1687
<http://www.us.onkyo.com/>

<Germany>

Gutenbergstrasse 3, 82178 Puchheim, Germany
Tel: +49-8142-4401-0 Fax: +49-8142-4208-213
<http://www.eu.onkyo.com/>

<UK>

Anteros Building, Odyssey Business Park, West End Road, South Ruislip, Middlesex,
HA4 6QQ United Kingdom
Tel: +44 (0)871-200-1996 Fax: +44 (0)871-200-1995
For Product Support only: +44 (0)208-836-3510
<http://www.uk.onkyo.com/en/>

<France>

6, Avenue de Marais F - 95816 Argenteuil Cedex FRANCE
For Product Support only: +33 969 368 138
<http://www.fr.onkyo.com/fr/>

<Hong Kong>

Unit 1033, 10/F, Star House, No 3, Salisbury Road, Tsim Sha Tsui Kowloon, Hong Kong.
Tel: +852-2429-3118 Fax: +852-2428-9039
<http://www.hk.onkyo.com/>

<PRC>

302, Building 1, 20 North Chaling Rd., Xuhui District, Shanghai, China 200032,
Tel: +86-21-52131366 Fax: +86-21-52130396
<http://www.cn.onkyo.com/>

<Asia, Oceania, Middle East, Africa>

Please contact an Onkyo distributor referring to Onkyo SUPPORT site.
<http://www.intl.onkyo.com/support/>

The above-mentioned information is subject to change without prior notice.
Visit the Onkyo web site for the latest update.

