

Pioneer

SX-10AE

STEREO RECEIVER

▶ Instruction Manual

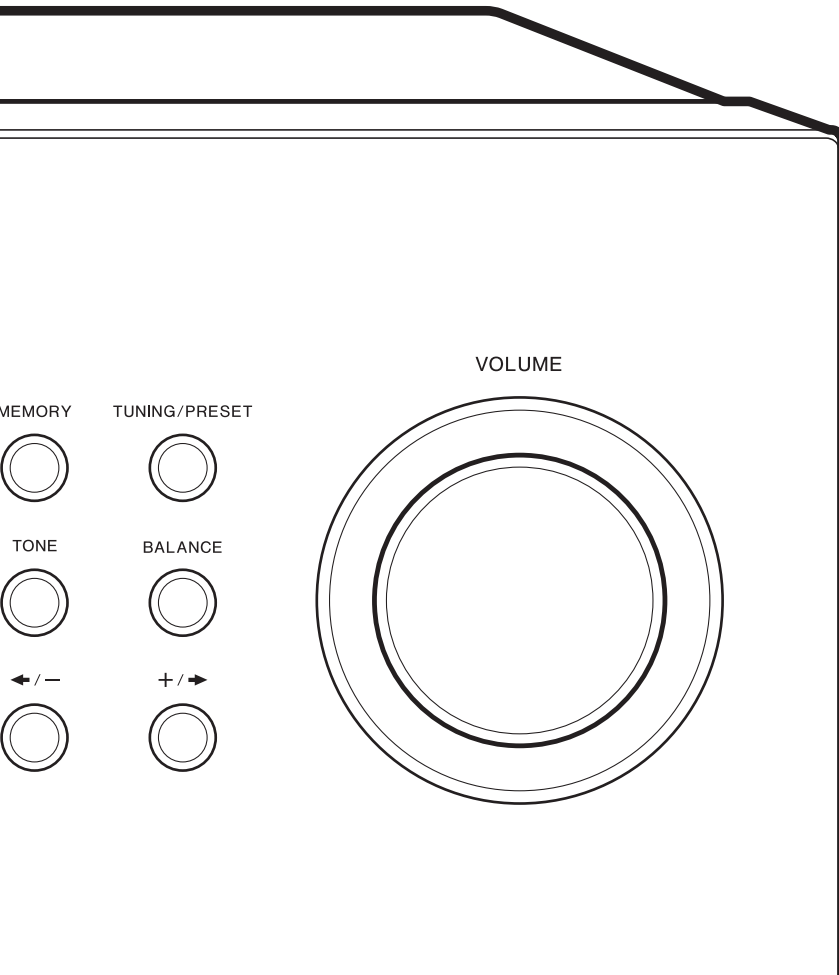
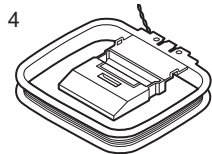
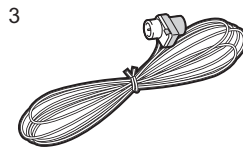
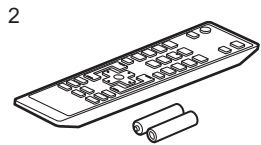
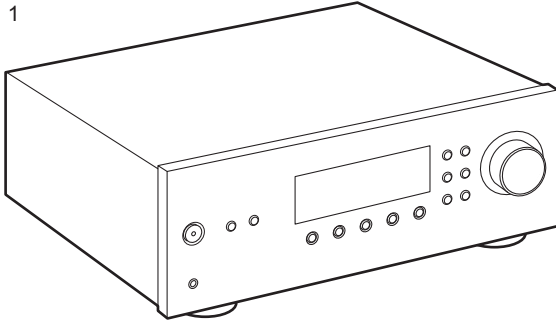

Table of Contents

Before Start	2
What's in the box	3
Part Names	4
Part Names	4
Install	8
Step1: Connect the Speakers	8
Step2: Connect an other External Device	9
Step3: Connect Other Cables	10
Playback	11
Playing Audio from a Connected Device	11
BLUETOOTH® Playback	12
Listening to the AM/FM Radio.....	13
Registering a Station	15
Naming Radio Stations Registered as Presets	16
Adjusting the Sound Quality	17
Setup	18
Setup Menu	18
Others	21
Troubleshooting	21
General Specifications	23

What's in the box



1. Main unit (1)
 2. Remote controller (RC-963R) (1), batteries (AAA/R03) (2)
 3. FM indoor antenna (1)
 4. AM indoor antenna (1)
 - Instruction Manual (This document) (1)
- Connect speakers with 4 Ω to 16 Ω impedance. Note that when connecting to both SPEAKERS A and B terminals, connect speakers with 8 Ω to 16 Ω impedance to both A and B.
 - The power cord must be connected only after all other cable connections are completed.
 - We will not accept responsibility for damage arising from the connection of equipment manufactured by other companies.
 - Specifications and appearance are subject to change without prior notice.

Part Names

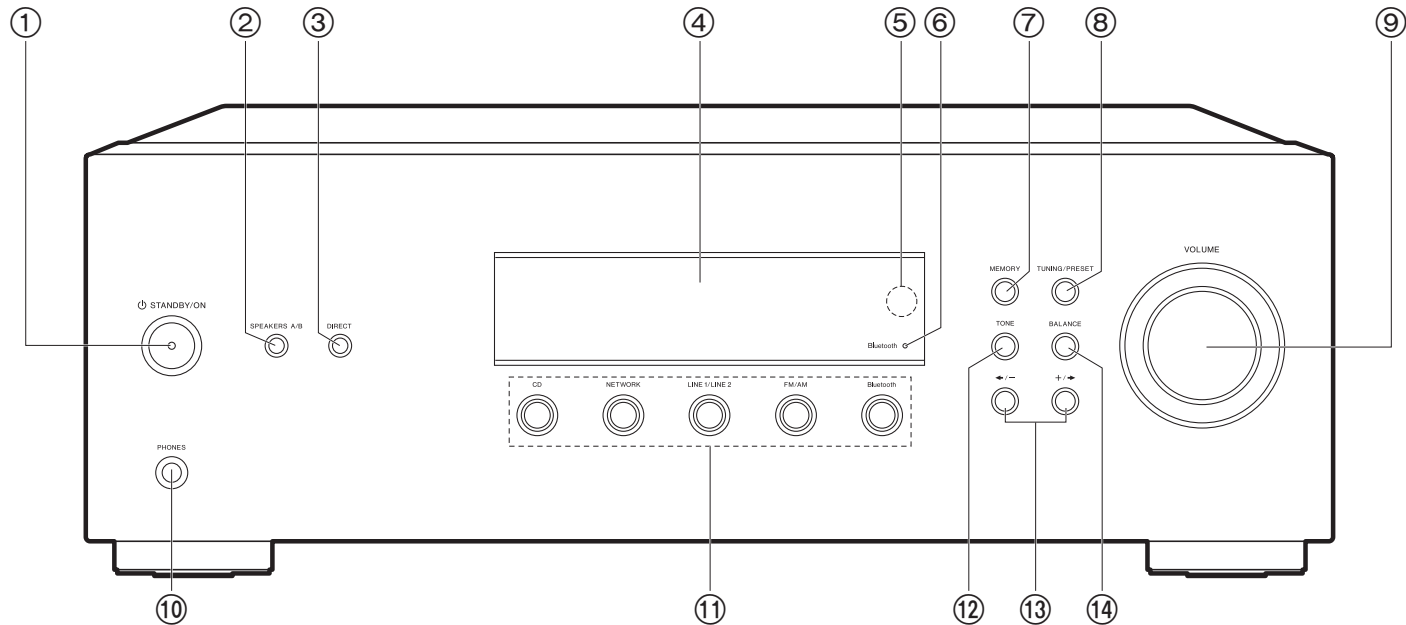

Front Panel

1. **STANDBY/ON** button
2. **SPEAKERS A/B** button: Select the terminals to output audio from between SPEAKERS A/B.
3. **DIRECT** button: Switches to the DIRECT mode which outputs pure sound as it was intended.
4. **Display (P5)**
5. **Remote control sensor**: Receives signals from the remote controller.
 - The signal range of the remote controller is within about 16'5 m, at an angle of 20° on the perpendicular axis and 30° to either side.
6. **Bluetooth indicator**: Lights when the unit is connected by BLUETOOTH. It will flash during pairing or if the connection is not correct.
7. **MEMORY** button: Used to register AM/FM radio stations (P15).
8. **TUNING/PRESET** button: Switch between the TUNING mode, where you select a frequency to tune to a station, and the PRESET mode, where you select a preset station.
9. **VOLUME**
10. **PHONES** jack: Connect stereo headphones with a standard plug (Ø1/4"/6.3 mm).
11. **Input Selector** buttons: Switches the input to be played.
12. **TONE** button: Switches to the TONE mode which enables BASS and TREBLE. After switching to the TONE mode, press again to see the settings for "Bass", "Treble", and "P.BASS" with each press.
13. **←/—, +/→** buttons: Used to tune to AM/FM stations, select preset numbers, and to adjust the sound quality.
14. **BALANCE** button: Adjusts the balance of the sounds output from the left and right speakers (P17).

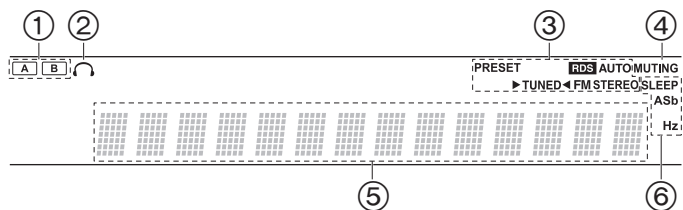

Display

1. The currently selected speaker system lights.
2. Lights when headphones are connected.
3. Lights in the following conditions.
 - PRESET: PRESET mode has been selected with TUNING/PRESET on the main unit.
 - RDS (European and Australian models): Receiving RDS broadcasting.
 - AUTO: When tuning mode is auto.
 - ▶TUNED◀: Receiving AM/FM radio.
 - FM STEREO: Receiving FM stereo.
4. Flashes when muting is on.
5. Displays radio and a variety of other information.
6. Lights in the following conditions.
 - SLEEP: Sleep timer has been set.
 - ASb: Auto Standby has been set.
 - Hz: May light while "Tuner Setting" in the Setup menu is being set.

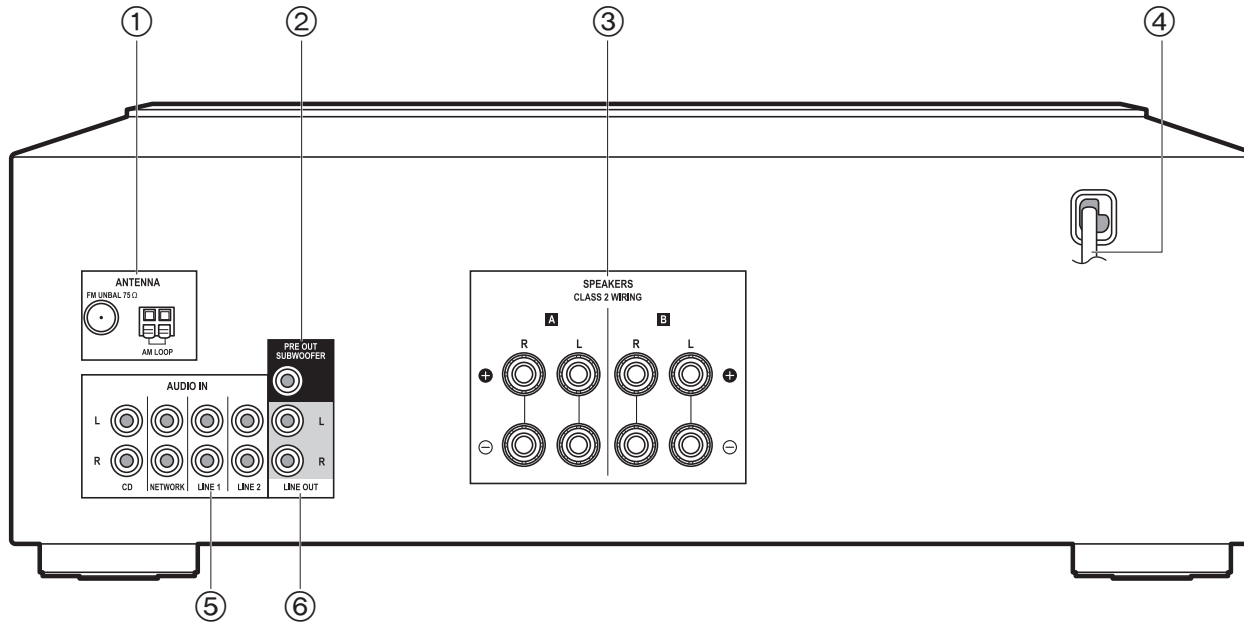

Rear Panel

1. FM UMBAL 75Ω/AM LOOP ANTENNA terminals: Connect the supplied FM indoor antenna and AM indoor antenna.
2. PRE OUT SUBWOOFER jack: Connect a powered subwoofer with a subwoofer cable.
3. SPEAKERS jacks: Connect speakers with speaker cables. You can connect a set of left and right speakers to each of the A/B terminals.
4. Power cord
5. AUDIO IN jacks: Input audio signals from an other external device with an analog audio cable.
6. LINE OUT jacks: Connect a recording device, such as a cassette tape deck. Connect to the AUDIO IN jacks on the recording device using analog audio cable.

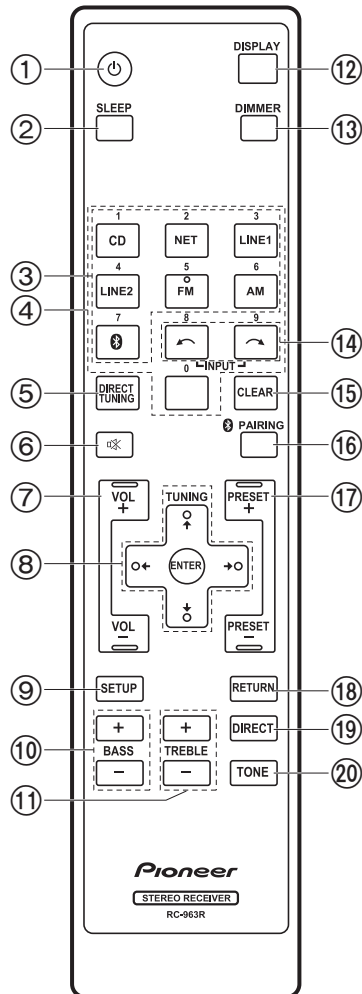

Remote Controller

1. ⏻ STANDBY/ON button
2. SLEEP button: Set the sleep timer (P20).
3. INPUT SELECTOR buttons: Switches the input to be played.
4. Numbered buttons
5. DIRECT TUNING button: Use to select the number of a preset station or to directly input the frequency of the station.
6. button: Temporarily mutes audio. Press again to cancel muting.
7. VOLUME buttons
8. Cursors (Up / Down / Left / Right), ENTER button: Select the item with the cursors and press ENTER to confirm.
9. SETUP button: You can show advanced setting items on the display to provide you with an even better experience (P18).
10. BASS buttons: Enhance or moderate the bass range (P17).
11. TREBLE buttons: Enhance or moderate the treble range (P17).
12. DISPLAY button: Switches the information on the display.
13. DIMMER button: You can adjust the brightness of the display in three steps. It cannot be turned off completely.
14. buttons: Select the input to be played. The input changes CD → NETWORK → LINE 1 → LINE 2 → FM → AM → BLUETOOTH each time you press the button.
15. CLEAR button: Deletes all characters you have entered when entering text.
16. PAIRING button: Used to connect to another BLUETOOTH wireless technology enabled device (P12).
17. PRESET buttons: Used to select AM/FM radio stations (P15).
18. RETURN button: Returns the display to the previous state during setting.
19. DIRECT button: Switches to the DIRECT mode which outputs pure sound as it was intended (P17).
20. TONE button: Switches to the TONE mode which enables BASS and TREBLE (P17).

Step1: Connect the Speakers

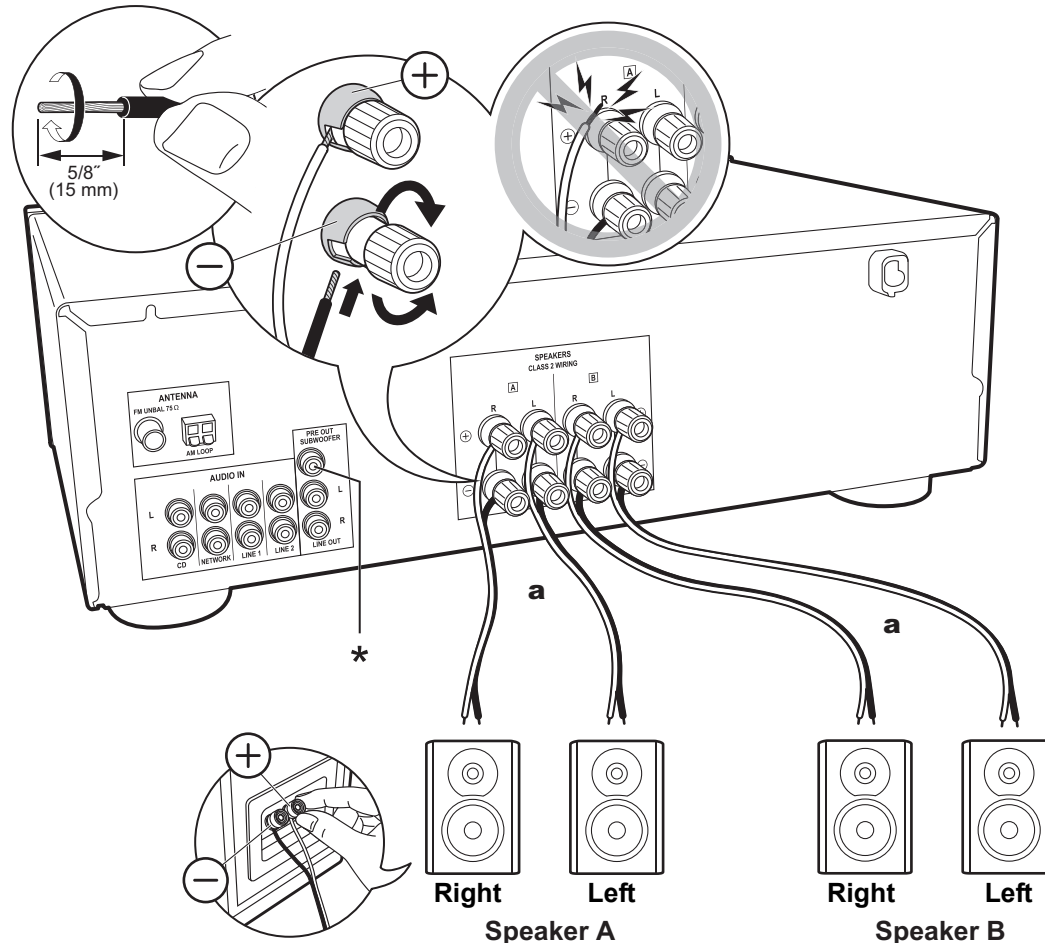

a Speaker Cable

You can connect two systems, Speaker A and Speaker B, as the Speaker System. When connecting only one set, connect to the SPEAKERS A terminals. With one set, use speakers with 4 Ω to 16 Ω impedance.

Note that when connecting to both SPEAKERS A and B terminals, connect speakers with 8 Ω to 16 Ω impedance to both A and B.

Connect the speaker cable so the wires do not protrude from the speaker jacks. If the exposed wires of the speakers touch the rear panel or the + and – wires touch each other, the protection circuit will be activated.



Setup

- When connected as a Speaker B System, you can output the same audio as Speaker A System by switching with A/B/A+B. Press SPEAKER A/B on the main unit to switch. The selection changes in the order SPEAKER A, SPEAKER B, SPEAKER A+B, Off with each press.
- If any of the connected speakers have an impedance of 4 Ω or more to less than 6 Ω, or when a Speaker B system is to be used, press SETUP (P7) on the remote controller, and set "SP Impedance" to "4 ohm".

(*) You can also connect a powered subwoofer to the PRE OUT SUBWOOFER jack to boost bass playback even more. Use a subwoofer cable for connection.

Step2: Connect an other External Device

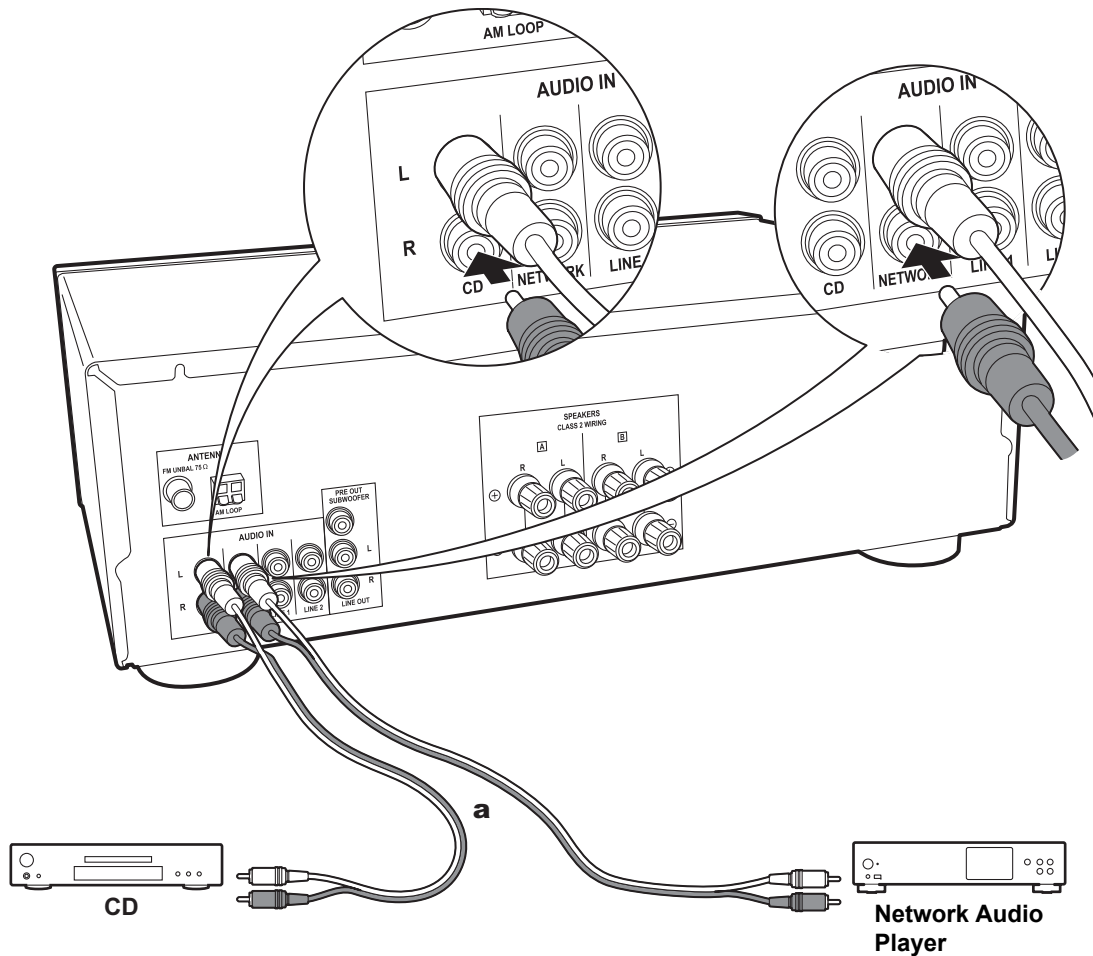

AUDIO IN connection

Connect an other external device with an analog audio cable.

a Analog Audio Cable

Step3: Connect Other Cables

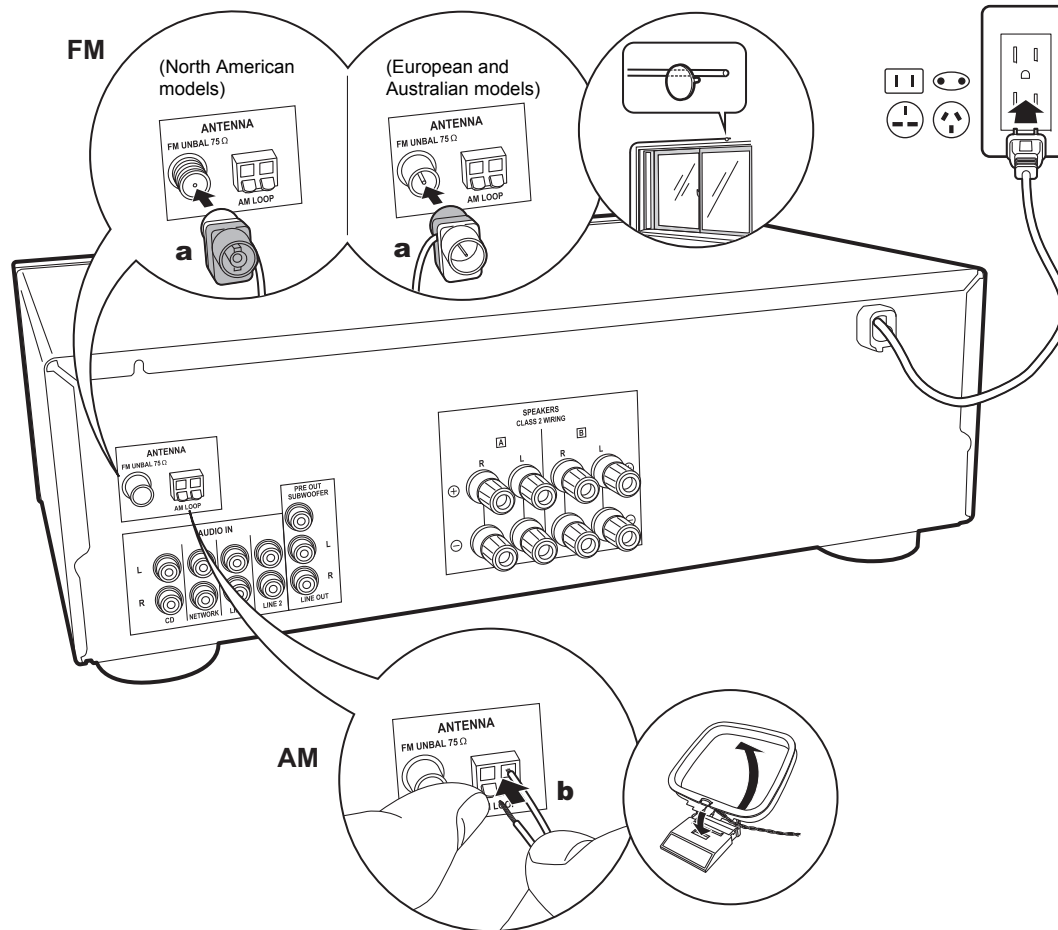

Antenna Hookup

Move the antenna around while playing the radio to find the position with the best reception.

Power Cord Hookup

The power cord must be connected only after all other connections are completed.

a FM indoor antenna, **b** AM indoor antenna

Playing Audio from a Connected Device

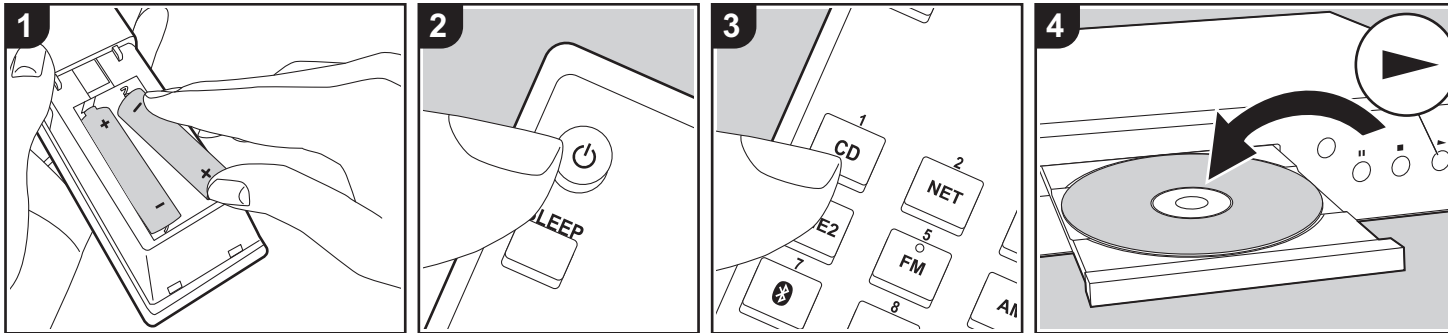

Basic Operations

You can play the audio from other external devices such as CD players through this unit.

Perform the following procedure when the unit is on.

1. Press the input selector button (a) on the remote controller with the same name as the jack to which you connected the player to switch the input.
For example, press CD to play the player connected to the CD jack. Press NET to listen the Network Audio Player's sound.
2. Start play on the connected player.

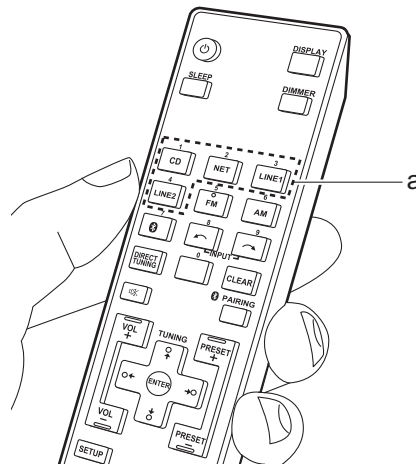

BLUETOOTH® Playback

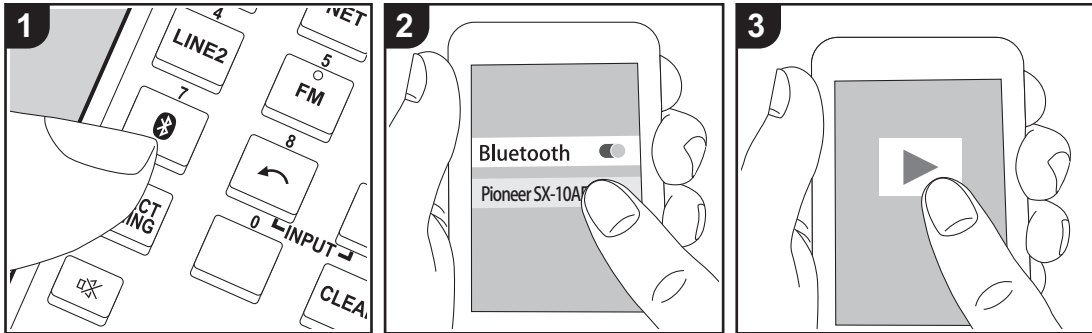

You can wirelessly play music on a smartphone or other BLUETOOTH wireless technology enabled device. Perform the following procedure when the unit is on.

Pairing

1. When you press  (a), "Now Pairing..." is displayed on this unit's display, and the pairing mode is enabled.

Now Pairing . . .

2. Enable (turn on) the BLUETOOTH function of the BLUETOOTH wireless technology enabled device, then select this unit from amongst the devices displayed. If a password is requested, enter "0000".
 - This unit is displayed as "Pioneer SX-10AE".
 - To connect another BLUETOOTH wireless technology enabled device, press PAIRING (b), then perform step

2. This unit can store the data of up to eight paired devices.

- The coverage area is 32'/10 m. Note that connection is not always guaranteed with all BLUETOOTH wireless technology enabled devices.

Playing Back

1. Perform the connection procedure on the BLUETOOTH wireless technology enabled device. The input on this unit automatically switches to "BLUETOOTH".
2. Play the music files. Increase the volume of the BLUETOOTH wireless technology enabled device to an appropriate level.
 - Due to the characteristics of BLUETOOTH wireless technology, the sound produced on this unit may slightly be behind the sound played on the BLUETOOTH wireless technology enabled device.

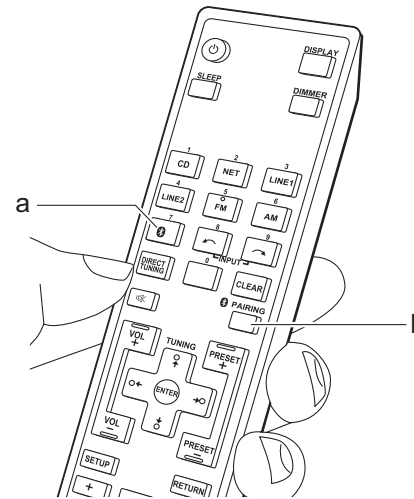

Listening to the AM/FM Radio

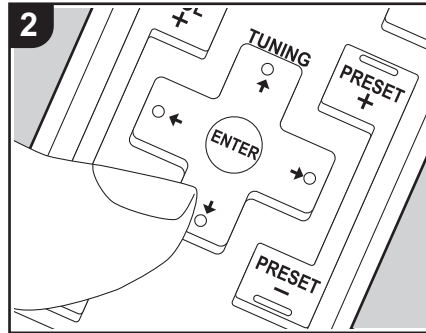
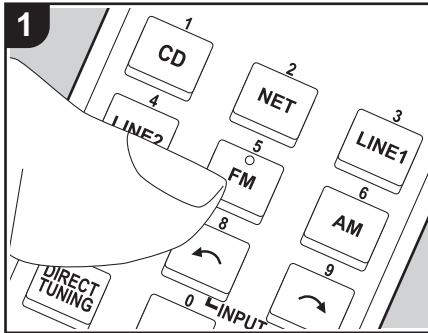

You can receive AM/FM radio stations on this unit with the built-in tuner. Perform the following procedure when the unit is on.

■ Tuning into a Radio Station

Tuning Automatically

The unit is set to the auto-tuning mode by default. If the signal from a radio station is weak, perform the procedure for "Tuning Manually" in the next section. Note that if you tune manually, the reception for FM broadcasts will be monaural rather than stereo, irrespective of the sensitivity of the reception.

1. Press AM or FM (e) on the remote controller.
2. When you press the cursor Up/Down buttons (c) on the remote controller, automatic tuning starts, and searching stops when a station is found. When tuned into a radio station, the "▶TUNED◀" indicator on the display lights. When tuned into a stereo FM

radio station, the "FM STEREO" indicator lights.

Tuning Manually

If you tune manually, the reception for FM broadcasts will be monaural rather than stereo, irrespective of the sensitivity of the reception.

1. Press AM or FM (e) on the remote controller.
2. After pressing SETUP (d) on the remote controller, use the cursor Up/Down buttons (c) to select "Mono" in "Tuner Setting" - "Tuning Mode", and then press ENTER to set.
3. While pressing the cursor Up/Down buttons (c) on the remote controller, select the desired radio station.
 - The frequency changes by 1 step each time you press Up/Down buttons. The frequency changes

continuously if the button is held down and stops when the button is released.

Tuning into Stations by Frequency

It allows you to directly enter the frequency of the radio station you want to listen to.

1. Press AM or FM (e) on the remote controller.
2. Press DIRECT TUNING (b) on the remote controller twice.
3. Using the number buttons (a) on the remote controller, enter the frequency of the radio station within 8 seconds.
 - To enter 87.5 (FM), for example, press 8, 7, 5 or 8, 7, 5, 0. If the entered number is incorrect, press DIRECT TUNING twice again and re-enter the number.

AM Frequency step setting (European and Australian models):

Press SETUP on the remote controller, then use the cursor buttons and ENTER on the remote controller to select "Tuner Setting" - "AM Freq Step", and select the frequency step for your region. Note that when this setting is changed, all radio presets are deleted.

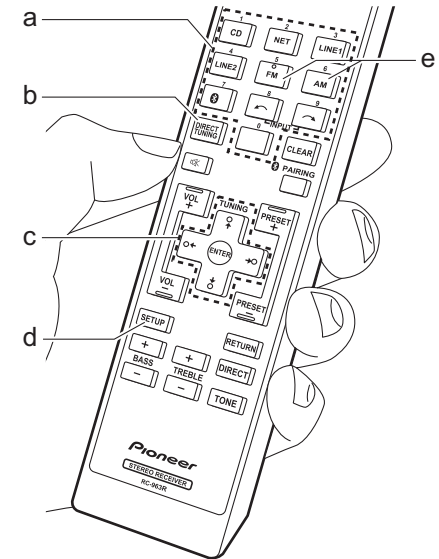

■ Using RDS (European and Australian models)

RDS stands for Radio Data System and is a method of transmitting data in FM radio signals. In regions using RDS, the radio station name is displayed when you tune into a radio station broadcasting program information. Further, when you press DISPLAY on the remote controller in this state, you can use the following functions.

Displaying Text Information (Radio Text)

1. While the name of the station is being displayed on the display, press DISPLAY on the remote controller once. Text information broadcast by the station (Radio Text) is displayed scrolling across the display. "No Text" is displayed when no text information is available.

Search for Stations by Program Type

1. While the name of the station is being displayed on the display, press DISPLAY on the remote controller twice.
2. Press the cursors Left/Right buttons on the remote controller to select the Program Type you want to find, then press ENTER to start the search.
 - The Program Types displayed are as follows: News (News reports) / Affairs (Current affairs) / Info (Information) / Sport / Educate (Education) / Drama / Culture / Science (Science and technology) / Varied / Pop M (Pop music) / Rock M (Rock music) / Easy

M (Middle of the road music) / Light M (Light classics) / Classics (Serious classics) / Other M (Other music) / Weather / Finance / Children (Children's programmes) / Social (Social affairs) / Religion / Phone In / Travel / Leisure / Jazz (Jazz music) / Country (Country music) / Nation M (National music) / Oldies (Oldies music) / Folk M (Folk music) / Document (Documentary)

- In addition, there are three other program types, Alarm, Test (Alarm test), and None. Alarm and Test (Alarm test) are used for emergency announcements. None appears when a program type cannot be found.
 - The information displayed may sometimes not match the content being broadcast by the station.
3. When a station is found, the station flashes on the display. Press ENTER while this is happening to start receiving that station. If you don't press ENTER, the unit continues to search for another station.
 - If no stations are found, the message "Not Found" is displayed.
 - Unusual characters may be displayed when the unit receives unsupported characters. However, this is not a malfunction. Also, if the signal from a station is weak, information may not be displayed.

Registering a Station

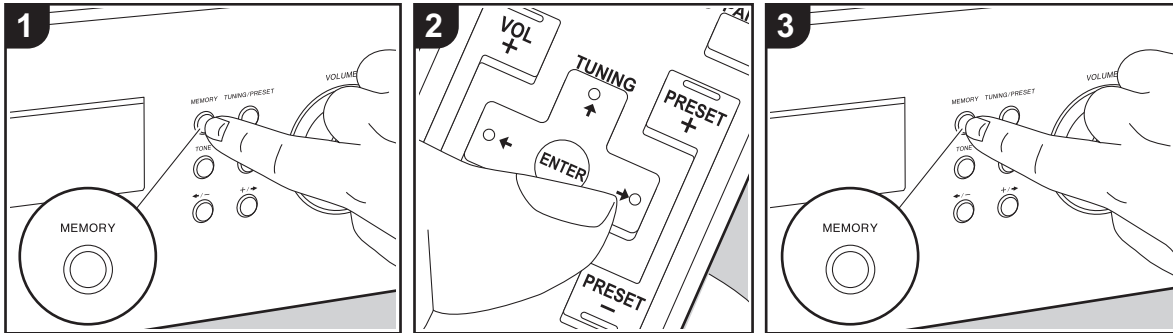

You can register up to 40 of your favorite radio stations.

Registering

After tuning into the radio station you want to register, perform the following procedure.

1. Press MEMORY on the main unit so that the preset number on the display flashes.



2. While the preset number is flashing (about 8 seconds), repeatedly press the cursor Left/Right buttons (b) on the remote controller to select a number between 1 and 40.

3. Press MEMORY again on the main unit to register the station.

When the station is registered, the preset number stops flashing. Repeat this procedure for all of your favorite radio stations.

Selecting a Preset Radio Station

1. Press AM or FM (a) on the remote controller.
2. Press PRESET (c) on the remote controller to select a preset number.

Deleting a Preset Radio Station

1. Press PRESET (c) on the remote controller to select the preset number to delete.
2. Press SETUP on the remote controller, then use the cursors and ENTER to start "Tuner Setting" - "Preset Erase" and delete the preset number. When deleted, the number on the display goes off.

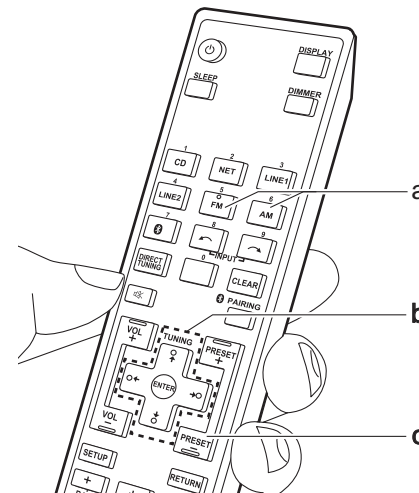

Naming Radio Stations Registered as Presets

You can enter names of up to 8 characters for the stations you have preset. Uses the following procedure.

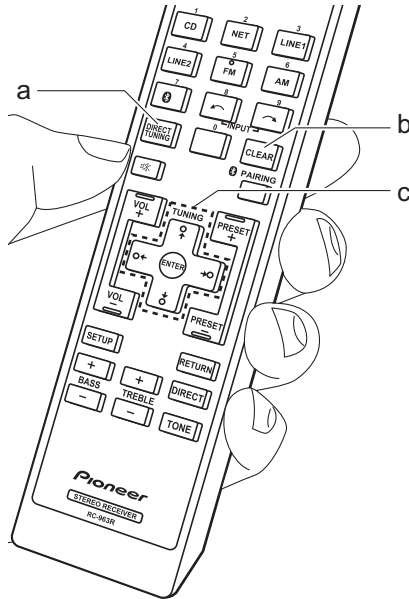

1. After pressing AM or FM on the remote controller, select a preset number.
2. After pressing SETUP on the remote controller, use the cursor Up/Down buttons (c) to select "Tuner Setting" - "Name Edit", and then press ENTER to set.
3. Select the characters or symbols with Up/Down/Left/Right buttons (c).
4. Press ENTER (c) to confirm the selected character. Repeat this to enter text.
 - Press DIRECT TUNING (a) to change the characters to be entered, for example to switch between upper and lower case.
 - Press CLEAR (b) to delete all the input characters.
5. After completing input, select "OK" with Up/Down/Left/Right buttons (c) and press ENTER (c).



Characters that can be entered

a

a	b	c	d	e	f	g	h	i	j	k	l	m
n	o	p	q	r	s	t	u	v	w	x	y	z
1	2	3	4	5	6	7	8	9	0	-	=	`
{	}		:	"	<	>	?	S	p	a	c	e
Shift		<	>	B	S	O	K					

A

A	B	C	D	E	F	G	H	I	J	K	L	M
N	O	P	Q	R	S	T	U	V	W	X	Y	Z
!	@	#	\$	%	^	&	*	()	_	+	~
[]	\	;	'	,	.	/	S	p	a	c	e
Shift		<	>	B	S	O	K					

Space: A single space the size of a character is entered.

Shift: Switches between characters displayed. (a → A)

← (left) / → (right): Select to move the cursor.

BS (backspace): Removes a character on the left of the cursor. The cursor moves left.

OK: Confirms the entered content.

Adjusting the Sound Quality

By pressing BASS, TREBLE, etc. on the remote controller during play, you can adjust frequently used settings, such as the sound quality.

- BALANCE adjustments can only be made with the buttons on the main unit.

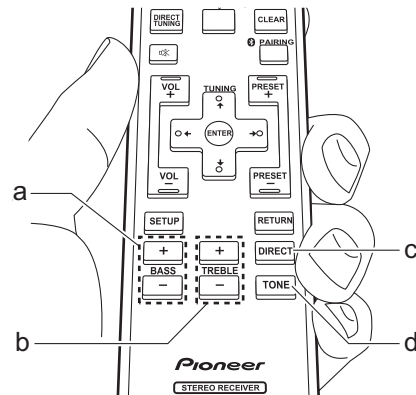

■ BASS (a)

Enhance or moderate the bass range of the speakers.

Select between -5 and $+5$ in 1 dB increments. (default value: 0)

- It cannot be set if the DIRECT mode is selected.

■ TREBLE (b)

Enhance or moderate the treble range of the speakers.

Select between -5 and $+5$ in 1 dB increments. (default value: 0)

- It cannot be set if the DIRECT mode is selected.

■ DIRECT (c)

Switch to the DIRECT mode which outputs pure sound as it was intended by bypassing the tone control circuits during play.

■ TONE (d)

Switch to the TONE mode which enables BASS and TREBLE.

■ P.BASS

P.BASS is enabled which emphasizes the bass. Repeatedly press TONE (d) to display "P.BASS", then press the Left/Right cursors to switch On or Off. (Default value: Off)

■ BALANCE (main unit only)

Adjust the balance of the sounds output from the left and right speakers. Select between L+10 and R+10 in 1 steps

increments. (default value: 0)

Setup Menu

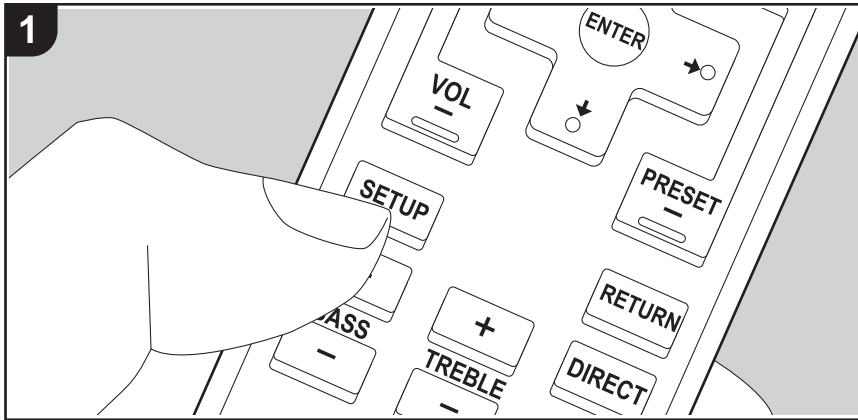

The unit allows you to configure advanced settings to provide you with an even better experience.

1. Press SETUP (b) on the remote controller.



2. Select the item with the Up/Down buttons (a) on the remote controller and press ENTER (d) to confirm your selection.
3. Select the submenu with the Up/Down buttons (a) on the remote controller.
4. Select the setting value with the Left/Right buttons (c) on the remote controller and press ENTER (d) to confirm your selection.
 - To return to the previous display, press RETURN (e).
5. To exit the settings, press SETUP (b).

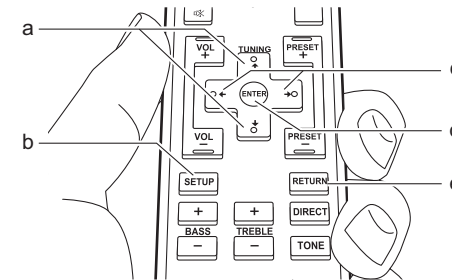

AutoStandby

This setting places the unit on standby automatically after 20 minutes of inactivity without any audio input.

"On": The unit will automatically enter standby mode. "ASb" lights on the display.

"Off": The unit will not automatically enter standby mode.

- "AutoStandby" is displayed on the display 30 seconds before the Auto Standby comes on.
- Default values vary depending on the regions.

SP Impedance

Set the impedance (Ω) of the connected speakers.

"4 ohm": When any of the connected speakers have 4 Ω or more to less than 6 Ω impedance, or when speaker systems are connected to both of the SPEAKERS A/B terminals

"6 ohm (default value)": When the connected speakers all have 6 Ω or more impedance

- Note that when connecting to both SPEAKERS A and B terminals, connect speakers with 8 Ω to 16 Ω impedance to both A and B.
- For impedance, check the indications on the back of the speakers or their instruction manual.

Tuner Setting

The setting cannot be selected when input other than "AM" or "FM" is selected.

Preset Write	You can register up to 40 of your favorite radio stations. While the preset number is flashing (about 8 seconds), repeatedly press the cursor Left/Right buttons on the remote controller to select a number between 1 and 40.
Preset Erase	Delete a registered preset number. <ul style="list-style-type: none"> • This setting is not available if you have not selected a preset number.
Name Edit	Set simple names for the stations you have preset. The set name will be shown on the main unit display. To name a preset radio station, after pressing AM or FM on the remote controller, select the preset number. For details on how to enter text, refer to "Naming Radio Stations Registered as Presets" (P16). <ul style="list-style-type: none"> • This setting is not available if you have not selected a preset number.
AM Freq Step (European and Australian models)	Select a frequency step depending on your area of residence. Select "9 kHz (default value)" or "10 kHz". <ul style="list-style-type: none"> • When this setting is changed, all radio presets are deleted.
Tuning Mode	Switches tuning to AM/FM automatic tuning/manual tuning. "Auto (default value)": Tuning Automatically. "Mono": Tuning Manually.

Bluetooth

Bluetooth	Select whether or not to use the BLUETOOTH function. "On (default value)": Enables connection with a BLUETOOTH wireless technology enabled device by using the BLUETOOTH function. Select "On" also when making various BLUETOOTH settings. "Off": When the BLUETOOTH function is not to be used
AutoChange	The input of the unit will automatically be switched to "BLUETOOTH" when connection is made from a BLUETOOTH wireless technology enabled device to the unit. "On (default value)": The input will automatically become "BLUETOOTH" when a BLUETOOTH wireless technology enabled device is connected. "Off": The function is disabled. <ul style="list-style-type: none"> • If the input is not switched automatically, set to "Off" and change the input manually.
Reconnect	This function automatically reconnects to the BLUETOOTH wireless technology enabled device connected last when you change the input to "BLUETOOTH". "On (default value)": When this function is to be used "Off": When this function is not to be used <ul style="list-style-type: none"> • This may not work with some BLUETOOTH wireless technology enabled devices.
Pairing Info	You can initialize the pairing information saved on this unit. Pressing ENTER when "Clear" is displayed initializes the pairing information stored in this unit. <ul style="list-style-type: none"> • This function does not initialize the pairing information on the BLUETOOTH wireless technology enabled device. When pairing the unit again with the device, be sure to clear the pairing information on the BLUETOOTH wireless technology enabled device in advance. For information on how to clear the pairing information, refer to the BLUETOOTH wireless technology enabled device's instruction manual.

Device	Displays the name of the BLUETOOTH wireless technology enabled device connected to the unit. <ul style="list-style-type: none">• The name is not displayed when "Stat" is "Ready" or "Pairing".
Stat	Displays the status of the BLUETOOTH wireless technology enabled device connected to the unit. "Ready": Not paired "Pairing": Pairing "Connected": Successfully connected

Sleep Timer

You can make the unit enter standby automatically when the specified time elapses.

1. Press SLEEP on the remote controller to display the time to set on the display.



- Press SLEEP repeatedly on the remote controller to make the setting in 10-minute steps from "90", "80", "70", down to "OFF".
- After pressing SLEEP on the remote controller, you can make the setting in 1-minute steps by repeatedly pressing the Up/Down buttons on the remote controller.
- To see how much time is left on the Sleep time, press SLEEP on the remote controller. While the remaining time is being displayed, you can reduce the set time in 10-minute steps by pressing SLEEP on the remote controller.

Troubleshooting

Before starting the procedure

Problems may be solved by simply turning the power on/off or disconnecting/connecting the power cord, which is easier than working on the connection, setting and operating procedure. Try the simple measures on both the unit and the connected device. If the problem isn't fixed after referring to "Troubleshooting", resetting the unit to the status at the time of shipment may solve the problem. Note that your settings will also be initialized when you reset, so we recommend that you note down your settings before doing the following.

- This unit contains a microPC for signal processing and control functions. In very rare situations, severe interference, noise from an external source, or static electricity may cause it to lockup. In the unlikely event that this happens, unplug the power cord from the wall outlet, wait at least 5 seconds, and then plug it back in.
- We are not responsible for reparations for damages (such as CD rental fees) due to unsuccessful recordings caused by the unit's malfunction. Before you record important data, make sure that the material will be recorded correctly.

If operation becomes unstable

Try unplugging the power cord of the unit and connected devices, and then plugging them in again.

Resetting the unit (this resets the unit settings to the default)

If the issue is not fixed by unplugging the power cord, resetting the unit to the status at the time of shipment may solve the problem. Your settings will also be initialized when you reset, so note down your settings before doing the following.

1. While holding down SPEAKERS A/B on the main unit, press  STANDBY/ON.
2. The unit switches to standby and the settings are reset.

■ Power

Cannot turn on the unit

- Make sure that the power cord is properly plugged into the wall outlet.
- Unplug the power cord from the wall outlet, wait 5 seconds or more, then plug it in again.

The unit turns off unexpectedly

- The unit automatically switches to standby when the "AutoStandby" setting in the Setup menu functions.
- A speaker cable may have shorted and the protective circuit function may have been activated. Make sure bare speaker wires are not touching each other or the back panel of the unit, then turn the unit on again. If "NG" is displayed, immediately unplug the power cord from the wall outlet and contact your dealer.
- The protective circuit function may have been activated because the temperature of the unit rose abnormally. If this happens, then the power will continue to turn off after you have turned the unit on again. Make sure the unit has plenty of space for ventilation around it, wait for the unit to cool down sufficiently, and then try turning it on again.

WARNING: If smoke, smell or abnormal noise is produced by the unit, unplug the power cord from the wall outlet immediately and contact the dealer or customer support.

■ Audio

- Confirm that the connection between the output jack on the device and the input jack on this unit is correct.
- Make sure that none of the connecting cables are bent, twisted, or damaged.
- If the MUTING indicator on the display flashes, press  on the remote controller to cancel muting.
- While headphones are connected to the PHONES jack, no sound is output from the speakers.

No sound from an other connected external device

- Change the input selector on this unit to the position of the terminal to which the other external device is connected.

A speaker produces no sound

- Make sure that the polarity of the speaker cables (+/-) is correct, and that no bare wires are in contact with the metal part of speaker terminals.
- Make sure that the speaker cables have not shorted.
- Make sure the speakers are connected correctly (P8).

Noise can be heard

- Using cable ties to bundle analog audio cables, power cord, speaker cables, etc. may degrade the audio performance. Do not bundle cords.
- An audio cable may be picking up interference. Try repositioning your cables.

■ AM/FM broadcasting

Radio reception is poor or there is a lot of noise

- Re-check the antenna connection.
- Separate the antenna from speaker cables and the power cord.
- Move the unit away from your TV or PC.
- Passing cars and airplanes can cause interference.
- Concrete walls weaken radio signals.
- Listen to the station in mono.
- When listening to an AM station, operating the remote controller may cause noise.
- FM reception may become clearer if you use the antenna jack on the wall used for the TV.

■ The BLUETOOTH feature

- Try plugging/unplugging the power of the unit and try turning on/off the BLUETOOTH wireless technology enabled device. Restarting the BLUETOOTH wireless

technology enabled device may be effective.

- The BLUETOOTH wireless technology enabled devices must support the A2DP profile.
- Radio wave interference may occur in the vicinity of components, such as microwave ovens or cordless phones, which use radio waves in the 2.4 GHz range. This interference may render this unit unusable.
- If there is a metallic object near the unit, BLUETOOTH connection may not be possible as the metal can effect on the radio waves.

Cannot connect with this unit

- Check that the BLUETOOTH function of the BLUETOOTH wireless technology enabled device is enabled.

Music playback is unavailable on the unit even after successful BLUETOOTH connection

- When the audio volume of your BLUETOOTH wireless technology enabled device is set low, the playback of audio may be unavailable. Turn up the volume on the BLUETOOTH wireless technology enabled device.
- Some BLUETOOTH wireless technology enabled devices may be equipped with a Send/Receive selector switch. Select Send mode.
- Depending on the characteristics or specifications of your BLUETOOTH wireless technology enabled device, playback on this unit may not be possible.

Sound is interrupted

- There may be a problem with the BLUETOOTH wireless technology enabled device. Check the information on the internet.

The audio quality is poor after connection with a BLUETOOTH wireless technology enabled device

- Reception is poor. Move the BLUETOOTH wireless technology enabled device closer to the unit or remove any obstacle between the BLUETOOTH wireless technology enabled device and this unit.

■ Remote Controller

- Make sure that the batteries are installed with the correct polarity.
- Install new batteries. Do not mix different types of batteries, or old and new batteries.
- Make sure that the unit is not subjected to direct sunshine or inverter-type fluorescent lights. Relocate if necessary.
- If the unit is installed in a rack or cabinet with colored-glass doors or if the doors are closed, the remote controller may not work reliably.

■ Display

The display doesn't light

- The display may go dim while the Dimmer is working. Press DIMMER to change the brightness level of the display.

■ Others

Strange noises can be heard from the unit

- If you have connected another unit to the same wall outlet as this unit, this noise may be an effect from the other unit. If the symptoms improve by unplugging the power cord of the other unit, use different wall outlets for this unit and the other unit.

General Specifications

Amplifier (Audio) section

Rated Output Power (FTC) (North American)

- With 8 ohm loads, both channels driven, from 20 - 20,000 Hz; rated 45 watts per channel minimum RMS power, with no more than 0.08% total harmonic distortion from 250 milliwatts to rated output.
- With 6 ohm loads, both channels driven, at 1 kHz; rated 85 watts per channel minimum RMS power, with no more than 0.9% total harmonic distortion from 250 milliwatts to rated output.

Rated Output Power (IEC) (European and Australian)

2 ch × 100 W at 6 ohms, 1 kHz, 1ch Driven of 1%THD

MAXIMUM Effective Output Power (JEITA)

2 ch × 100 W at 6 ohms, 1 kHz, 2ch Driven of 10%THD

Dynamic Power (*)

(*)IEC60268-Short-term maximum output power

140 W (3 Ω)

120 W (4 Ω)

80 W (8 Ω)

THD+N (Total Harmonic Distortion+Noise)

0.08% (20 - 20,000 Hz, half power)

Input Sensitivity and Impedance

450 mV/40 kΩ (LINE (Unbalance))

Rated RCA Output Level and Impedance

420 mV/2.2 kΩ (LINE OUT)

2.8 V/3.3 kΩ (SUBWOOFER PRE OUT)

Frequency Response

10 Hz - 100 kHz/+1 dB, -3 dB (DIRECT)

Tone Control Characteristics

±10 dB, 100 Hz (BASS)

±10 dB, 10 kHz (TREBLE)

4 dB (P.BASS)

Signal to Noise Ratio

100 dB (IHF-A, LINE IN, SP OUT)

Speaker Impedance

4 Ω - 16 Ω

Headphone Output Impedance

390 Ω

Headphone Rated Output

60 mW (32 Ω, 1 kHz, 10%THD)

Tuner Section

FM Tuning Frequency Range

87.5 MHz - 107.9 MHz (North American)

87.5 MHz - 108.0 MHz, RDS (European and Australian)

AM Tuning Frequency Range

530 kHz - 1710 kHz (North American)

9 kHz Frequency Step (Default value): 522 kHz -

1611 kHz (European and Australian)

10 kHz Frequency Step: 530 kHz - 1710 kHz (European

and Australian)

Preset Channel

40

BLUETOOTH Section

Communication system

BLUETOOTH Specification version 4.2

Frequency band

2.4 GHz band

Modulation method

FHSS (Frequency Hopping Spread Spectrum)

Compatible BLUETOOTH profiles

A2DP 1.3

AVRCP 1.5

Supported Codecs

SBC

AAC

Transmission range (A2DP)

20 Hz - 20 kHz (Sampling frequency 44.1 kHz)

Maximum communication range

Line of sight approx. 32 ft. / 10 m (*)

(*)The actual range will vary depending on factors such as obstacles between devices, magnetic fields around a microwave oven, static electricity, cordless phone, reception sensitivity, antenna's performance, operating system, software application, etc.

General

Power Supply

AC 120 V, 60 Hz (North American)

AC 220-240 V, 50/60 Hz (European and Australian)

Power Consumption

150 W (North American)

160 W (European and Australian)

0.4 W (Stand-by)

20 W (No-sound)

Dimensions (W × H × D)

435 mm × 147 mm × 321 mm

17-1/8" × 5-13/16" × 12-5/8"

Weight

6.7 kg / 14.8 lbs (North American)

7 kg / 15.4 lbs (European and Australian)

Audio Inputs

Analog

CD, NETWORK, LINE1, LINE2

Audio Outputs

Analog

PRE OUT SUBWOOFER

LINE OUT L/R

Speaker Outputs

SPEAKERS A: L/R

SPEAKERS B: L/R

Phones

PHONES (Front, Ø1/4"/6.3 mm)



The BLUETOOTH® word mark and logos are registered trademarks owned by Bluetooth SIG, Inc.

All other trademarks are the property of their respective owners. / Toutes les autres marques commerciales sont la propriété de leurs détenteurs respectifs. / El resto de marcas comerciales son propiedad de sus respectivos propietarios. / Tutti gli altri marchi di fabbrica sono di proprietà dei rispettivi proprietari. / Alle anderen Warenzeichen sind das Eigentum ihrer jeweiligen Eigentümer. / Alle andere handelsmerken zijn eigendom van de desbetreffende rechthebbenden. / Alla andra varumärken tillhör deras respektive ägare. / Kaikki muut tuotemerkit ovat omistajiensa omaisuutta. / 所有其他商標為各自所有者所有。

Pioneer

2-3-12 Yaesu, Chuo-ku, Tokyo 104-0028 JAPAN

<U.S.A.>

18 PARK WAY, UPPER SADDLE RIVER, NEW JERSEY 07458, U.S.A.

Tel: 1-201-785-2600 Tel: 1-844-679-5350

<Germany>

Hanns-Martin-Schleyer-Straße 35, 47877 Willich, Germany

Tel: +49(0)8142 4208 188 (Product Support)

<UK>

Anteros Building, Odyssey Business Park, West End Road, South Ruislip,

Middlesex, HA4 6QQ United Kingdom

Tel: +44(0)208 836 3612

<France>

6, Avenue de Marais F - 95816 Argenteuil Cedex FRANCE

Tel: +33(0)969 368 050

Корпорация О энд Пи

2-3-12, Яэсу, Чуо-ку, г. Токио, 104-0028, ЯПОНИЯ

Register your product on

<http://www.pioneerelectronics.com> (US)

<http://www.pioneerelectronics.ca> (Canada)

<http://www.pioneer.eu> (Europe)

© 2017 Onkyo & Pioneer Corporation. All rights reserved.

© 2017 Onkyo & Pioneer Corporation. Tous droits de reproduction et de traduction réservés.

"Pioneer" is a trademark of Pioneer Corporation, and is used under license.

Printed in Malaysia / Imprimé en Malaisie

SN 29403247

F1707-0



* 2 9 4 0 3 2 4 7 *