

Multi Channel AV Receiver/Multi Channel AV Amplifier
STR-AN1000/TA-AN1000



Use this Help Guide when you have any questions on how to use the receiver/amplifier.

This Help Guide mainly describes the procedures for using the remote control. You can also use the controls on the receiver/amplifier if they have the same or similar names as those on the remote control.

The US, Canadian, and Asia-Pacific models are used for illustrative purposes in this Help Guide unless otherwise noted.

Parts and Controls

Receiver/Amplifier

[Front panel](#)

[Indicators on the display panel](#)

[Rear panel](#)

Remote control

[Remote control](#)

[Remote control buttons that can be operated for each zone](#)

Preparation

[About input/output of video signals](#)

Supported audio/video formats

[Playable types of audio files](#)

[Digital audio formats supported by the unit](#)

[Video formats supported by the unit](#)

Notes on connections

[Notes on connecting cables](#)

[About HDMI connections](#)

1. Installing speakers

[Speaker installation example](#)

[Speaker configuration and speaker pattern settings](#)

[Installing 5.1-channel speaker system](#)

[Installing 7.1-channel speaker system using surround back speakers](#)

[Installing 5.1.2-channel speaker system using top middle speakers](#)

[Installing 5.1.2-channel speaker system using front Dolby Atmos enabled speakers](#)

[Installing 5.1-channel speaker system with Zone 3 connection](#)

[Installing 5.1-channel speaker system with bi-amplifier connection](#)

[Installing 5.1-channel speaker system with front B speaker connection](#)

2. Connecting speakers

[How to connect speaker cables](#)

[Using an active subwoofer](#)

[Connecting 5.1-channel speaker system](#)

[Connecting 7.1-channel speaker system using surround back speakers](#)

[Connecting 5.1.2-channel speaker system using top middle speakers](#)

[Connecting 5.1.2-channel speaker system using front Dolby Atmos enabled speakers](#)

[Connecting 5.1-channel speaker system with Zone 3 connection](#)

[Connecting 5.1-channel speaker system with bi-amplifier connection](#)

[Connecting 5.1-channel speaker system with front B speaker connection](#)

[Connecting Sony wireless rear speakers/subwoofer](#)

3. Connecting a TV

[Notes on TV connection](#)

[Connecting a TV compatible with the eARC or ARC function using an HDMI jack](#)

[Connecting a TV incompatible with the eARC and ARC functions using an HDMI jack](#)

[Connecting a TV with jacks other than HDMI jacks](#)

[Connecting a TV and a projector using an HDMI jack](#)

[Setting TV audio output \(when using the eARC/ARC function\)](#)

[Setting TV audio output \(when not using the eARC/ARC function\)](#)

[When your TV has the S-CENTER SPEAKER IN jack](#)

4. Connecting audio-visual devices and the antennas (aerials)

[Connecting devices with HDMI jacks](#)

[When the eARC/ARC-compatible HDMI input jack of your TV is incompatible with 8K video input](#)

[Connecting devices with jacks other than HDMI jacks](#)

[Connecting a USB device](#)

[Connecting the antenna \(aerial\) \(for US, Canadian, and Asia-Pacific models only\)](#)

5. Connecting to the network

[Connecting a LAN cable \(for wired LAN connections only\)](#)

[Connecting the unit to the network using the wireless LAN antenna \(for wireless LAN connections only\)](#)

6. Preparing the unit

[Inserting batteries into the remote control](#)

[Assembling the calibration mic stand](#)

[Connecting the calibration microphone](#)

[Turning on the unit](#)

[Setting up the unit using the \[Easy Setup\]](#)

[What you can do with Auto Calibration](#)

[Before you perform Auto Calibration](#)

[Auto Calibration operation](#)

[Selecting the front speakers](#)

[Checking Auto Calibration results](#)

Enjoying Video and Sound

[Content that can be played on the unit](#)

[How to use the menu of the unit](#)

[Viewing information on the display panel](#)

[Playing AV devices](#)

Playing content from a USB device

[Enjoying music stored on a USB device](#)

[USB specifications and compatible USB devices](#)

[Notes on USB devices](#)

Listening to the radio

[Listening to FM radio \(for US, Canadian, and Asia-Pacific models only\)](#)

[Presetting FM radio stations \(Preset Memory\) \(for US, Canadian, and Asia-Pacific models only\)](#)

[Naming preset stations \(Preset Name Input\) \(for US, Canadian, and Asia-Pacific models only\)](#)

[Tuning to a station directly \(Direct Tuning\) \(for US, Canadian, and Asia-Pacific models only\)](#)

[Receiving RDS broadcasts \(for Asia-Pacific models only\)](#)

Using BLUETOOTH Features

[What you can do with BLUETOOTH® features](#)

[Compatible BLUETOOTH version and profiles](#)

[Enjoying audio content using the BLUETOOTH function \(Pairing operation\)](#)

[Controlling a BLUETOOTH device using the remote control](#)

[Listening with BLUETOOTH headphones/speakers \(Pairing operation\)](#)

Using Network Features

[What you can do with network features](#)

[Notes on connecting to the Internet](#)

Setting up a wired LAN connection (for wired LAN connections only)

[Connecting a LAN cable \(for wired LAN connections only\)](#)

[Setting up a wired LAN connection](#)

Setting up a wireless LAN connection (for wireless LAN connections only)

[Connecting the unit to the network using the wireless LAN antenna \(for wireless LAN connections only\)](#)

[Setting up a wireless LAN connection](#)

[Setting up a Wireless Network Connection Using Sony | Music Center](#)

[Playing music with the TIDAL App](#)

Playing Music from Other Streaming Services

[Prerequisite: Making the Initial Settings for Chromecast built-in](#)

[Playing music with apps compatible with other streaming services](#)

[Using Spotify](#)

[Using Sony | Music Center](#)

Using AirPlay

[Enjoying audio content from iTunes or an iPhone/iPad/iPod touch via the network \(AirPlay\)](#)

Listening to music on your PC on the home network

[Listening to music on your PC via a home network](#)

[Formats compatible with home networks](#)

Using the Multi-Zone Features

Overview of multi-zone features

[What you can do with multi-zone features](#)

[Available input sources for each zone](#)

Enjoying video and sound on the amplifier and TV in Zone 2

[Connecting another amplifier or TV in Zone 2](#)

[Setting up Zone 2 \(Zone2 Settings\)](#)

[Enjoying video and sound on the amplifier and TV in Zone 2](#)

Enjoying sound from speakers located in another room (Zone 3)

[Connecting 5.1-channel speaker system with Zone 3 connection](#)

[Setting up Zone 3 \(Zone3 Settings\)](#)

[Enjoying sound using speakers in Zone 3](#)

Enjoying sound in two rooms (Main zone and Zone 3) using another amplifier

[Connecting another amplifier in Zone 3](#)

[Setting up Zone 3 \(Zone3 Settings\)](#)

[Enjoying sound using another amplifier in Zone 3](#)

Enjoying sound effects

[Enjoying 360 spatial sound \(360 Spatial Sound Mapping\)](#)

Using sound fields (Sound Field)

[Selecting a sound field \(Sound Field\)](#)

[Selectable sound fields and their effects](#)

[Relations between sound fields and speaker outputs](#)

[Resetting sound fields to the default settings](#)

[Adjusting the equalizer \(Equalizer\)](#)

[Enjoying more natural sound with speakers installed in the ceiling \(In-Ceiling Speaker Mode\)](#)

[Enjoying high-fidelity sound \(Pure Direct\)](#)

[Using the DTS:X Dialog Control function](#)

Using Other Features

Using the unit by Interlocking with a TV

[Operating the unit by Interlocking with a TV \(Control for HDMI function\)](#)

[Operating the unit by interlocking with a TV compatible with the "BRAVIA" Sync function](#)

Enjoying video and sound with desired way of use

[Switching the TVs that output the HDMI video signals](#)

[Switching between digital and analog audio \(Input Mode\)](#)

[Using other digital audio input jacks \(Input Assign\)](#)

Saving and recalling various settings (Custom Preset)

[About Custom Preset](#)

[Saving the settings to a preset](#)

[Recalling the preset settings](#)

[Items for which you can save settings and the default values for each item](#)

[Saving power during standby mode](#)

Adjusting Settings

Easy Setup

[Performing Easy Setup](#)

Input Settings

[Changing the name for each input \(Name\)](#)

[Changing the assignment and display for the input jacks](#)

[Switching between digital and analog audio \(Input Mode\)](#)

[Using other digital audio input jacks \(Input Assign\)](#)

Speaker Settings

[Switching the speaker configuration \(Speaker Configuration Selection\)](#)

[Checking saved speaker configuration information \(Speaker Configuration Information\)](#)

[Performing Auto Calibration \(Auto Calibration Settings\)](#)

[Calibrating the phase characteristics of the speakers \(Automatic Phase Matching\)](#)

[Selecting the Auto Calibration type \(Calibration Type\)](#)

[Selecting a wireless speaker connection mode \(Link mode\)](#)

[Connecting wireless speakers manually \(Start manual linking\)](#)

[Checking the connection status of wireless speakers \(Check wireless connection\)](#)

[Setting to the optimum frequency for wireless speaker connection \(RF Channel\)](#)

- [Selecting the playback quality of the wireless speaker \(Wireless Playback Quality\)](#)
- [Checking the software version of the wireless speakers \(Software Version\)](#)
- [Outputting the center speaker part of the sound from the TV speakers \(TV Center Speaker Mode\)](#)
- [Lifting up the sound of the center speaker \(Center Speaker Lift Up\)](#)
- [Enjoying more natural sound with speakers installed in the ceiling \(In-Ceiling Speaker Mode\)](#)

Manual Speaker Settings

- [Outputting a test tone from each speaker \(Test Tone\)](#)
- [Adjusting the speaker level \(Level\)](#)
- [Adjusting the equalizer \(Equalizer\)](#)
- [Setting the distance from the listening position to the screen and each speaker \(Distance from Listening Position\)](#)
- [Setting the distance between the screen and each speaker \(Distance from the Screen\)](#)
- [Setting the height of the screen, listening position, and each speakers \(Height\)](#)
- [Adjusting the speaker size \(Size\)](#)
- [Setting the crossover frequency of the speakers \(Crossover Frequency\)](#)
- [Assigning wireless speakers \(Wireless Speaker Assign\)](#)
- [Assigning the surround back speaker terminals \(Surround Back Speaker Assign\)](#)
- [Selecting the speaker pattern \(Speaker Pattern\)](#)
- [Checking the speaker position and the corresponding speaker terminals \(Speaker Connection Guide\)](#)
- [Selecting the unit of measurement \(Distance Unit\)](#)

Network Settings

- [Setting up a wired LAN connection](#)
- [Setting up a wireless LAN connection](#)
- [Checking the network connection status \(Network Connection Status\)](#)
- [Receiving information on newer software \(Software Update Notification\)](#)
- [Updating the software automatically \(Auto Update Settings\)](#)
- [Setting acceptance or rejection of information collection \(Privacy Setting\)](#)
- [Checking information for Chromecast built-in function \(Chromecast built-in\)](#)
- [Setting to use the unit by connecting to a Sonos device \(Works with Sonos\)](#)

HDMI Settings

- [Upscaling video signals to 4K/8K \(4K/8K Upscaling\)](#)
- [Controlling HDMI devices \(Control for HDMI\)](#)

- [Turning off the unit and connected devices simultaneously with the TV \(System Power Off function\) \(Standby Linked to TV\)](#)
- [Enjoying content of a connected device without turning on the unit \(Standby Through\)](#)
- [Enabling the eARC/ARC function \(Audio Return Channel\)](#)
- [Setting the HDMI audio signal output of connected devices \(Audio Out\)](#)
- [Setting the level of the subwoofer \(Subwoofer Level\)](#)
- [Selecting the method to use the HDMI OUT B jack \(HDMI OUT B Mode\)](#)
- [Check information about the monitor connected via HDMI \(Monitor Information\)](#)
- [Setting HDMI signal formats \(HDMI Signal Format\)](#)
- [Displaying the video from external input while watching TV \(Video output for PIP/PBP-displayed TV\)](#)

Audio Settings

- [Enjoying 360 spatial sound \(360 Spatial Sound Mapping\)](#)
- [Enjoying overwhelming sound spread and a powerful sense of presence \(360 Spatial Sound Mapping\)](#)
- [Calibrating speaker positioning \(SpeakerRelocation / PhantomSurroundBack\)](#)
- [Enabling the direct playback of DSD signals \(DSD Native\)](#)
- [Enjoying high-fidelity sound \(Pure Direct\)](#)
- [Setting the low-pass filter for the subwoofer output \(Subwoofer Low Pass Filter\)](#)
- [Synchronizing audio with video output \(A/V Sync\)](#)
- [Selecting the language of digital broadcasts \(Dual Mono\)](#)
- [Making small sounds easier to hear \(Audio DRC\)](#)
- [Upmixing the 2-channel sound source \(Upmixer\)](#)
- [Selecting virtual sound effects \(Virtualizer\)](#)
- [Switching the IMAX Mode \(IMAX Mode\)](#)
- [Setting the speaker frequency when playing IMAX content \(IMAX Adjustment\)](#)

Zone Settings

- [Setting up Zone 2 \(Zone2 Settings\)](#)
- [Setting up Zone 3 \(Zone3 Settings\)](#)
- [Setting the volume control for Zone 3 \(Zone3 Line Out\)](#)

Bluetooth Settings

- [Selecting the BLUETOOTH mode \(Bluetooth Mode\)](#)
- [Checking the BLUETOOTH device list \(Device List\)](#)
- [Setting the connection quality for listening to audio of a mobile device using this unit \(Bluetooth Connection Quality\)](#)

[Setting the BLUETOOTH sound quality \(Wireless Playback Quality\)](#)

System Settings

[Selecting the language used on the menu of the unit displayed on the TV \(Language\)](#)

[Displaying the information on the screen when any settings are changed \(Auto Display\)](#)

[Turning on the unit via the network or BLUETOOTH function \(Network/Bluetooth Standby\)](#)

[Setting the unit to switch to standby mode automatically \(Auto Standby\)](#)

[Switching the brightness of the display panel \(Dimmer\)](#)

[Assigning a name to the unit \(Device Name Setting\)](#)

[Checking the software version and MAC address of the unit \(System Information\)](#)

[Checking software license information \(Software License Information\)](#)

[Setting the FM station receiving mode \(FM Mode\) \(for US, Canadian, and Asia-Pacific models only\)](#)

[Naming preset stations \(Preset Name Input\) \(for US, Canadian, and Asia-Pacific models only\)](#)

[Presetting the gain level of the FM tuner \(Preset Gain Level\) \(for US, Canadian, and Asia-Pacific models only\)](#)

Software Update

[Updating the software \(Software Update\)](#)

Resetting

[Reverting to the factory default settings](#)

Using the menu on the display panel

[Operating the unit with the menu on the display panel](#)

[Menu list \(on the display panel\)](#)

Troubleshooting

[If the unit does not work properly.](#)

Error messages

[\[PROTECTOR\] or \[THERMAL\] appears on the display panel.](#)

[\[ERROR\] appears on the display panel.](#)

[\[Overload has been detected.\] appears on the TV screen.](#)

[List of messages after Auto Calibration measurements](#)

General

[The unit is turned off automatically.](#)

[Cannot find an available input when connecting several digital devices.](#)

[The unit does not turn on even when the TV is turned on.](#)

[The unit turns off when the TV is turned off.](#)

[The unit does not turn off even when the TV is turned off.](#)

Image

[No image appears on the TV screen.](#)

[4K or 8K content cannot be displayed at the same resolution as the source.](#)

[No image is output to the TV from the connected HDMI device when the unit is in standby mode.](#)

[The home menu does not appear on the TV screen.](#)

[HDR \(High Dynamic Range\) images cannot be displayed in HDR mode.](#)

[The indicator on the display panel turns off.](#)

[Image does not appear on the TV screen when the unit is not turned on.](#)

[When the language for the on-screen display of the TV is changed, the on-screen display language of the unit is changed simultaneously.](#)

Sound

[No sound or only a very low level of sound is heard, no matter which device is selected.](#)

[There is severe humming or noise.](#)

[No sound or only a very low level of sound is heard from specific speakers.](#)

[No sound is heard from the wireless speaker \(not supplied\).](#)

[Sound heard from the wireless speaker \(not supplied\) is unstable.](#)

[The sound is interrupted.](#)

[When a TV is connected to the unit via an HDMI OUT A \(TV\) jack that supports the eARC or ARC function, sound from the TV is not output from the speakers connected to the unit.](#)

[The center component of the audio is not output from the TV when using the TV as a center speaker by connecting the S-CENTER OUT jack of the unit to the S-CENTER SPEAKER IN jack of the TV. \(The Acoustic Center Sync function is not working\).](#)

[Cannot select the desired input for playback in Zone 2 or Zone 3.](#)

[No sound is heard from the active subwoofer or the center speaker.](#)

[Volume level of Zone 2 speakers cannot be adjusted.](#)

[There is no sound from a specific device.](#)

[The Dolby Atmos-compatible sound played back on the TV is not output from the unit.](#)

[The left and right sound is unbalanced or reversed.](#)

[Dolby Digital or DTS multi-channel sound is not reproduced.](#)

[The surround effect cannot be obtained.](#)

[A test tone is not output from the speakers.](#)

[A test tone is output from a different speaker than the speaker displayed on the TV screen.](#)

[No sound is output to the TV from the connected HDMI device when the unit is in standby mode.](#)

[TV sound cannot be heard from the speakers connected to the unit.](#)

[Image and sound are not output from the TV when the unit is not turned on.](#)

[The sound is output from both the unit and the TV.](#)

[There is a time gap between the visual display on the TV and the audio output from the speaker connected to the unit.](#)

Tuner

[The FM reception is poor \(for US, Canadian, and Asia-Pacific models only\).](#)

[The FM stereo reception is poor \(for US, Canadian, and Asia-Pacific models only\).](#)

[You cannot tune to radio stations \(for US, Canadian, and Asia-Pacific models only\).](#)

[RDS does not work \(for Asia-Pacific models only\).](#)

[The RDS information that you want does not appear \(for Asia-Pacific models only\).](#)

USB devices

[Are you using a compatible USB device?](#)

[When the music on the USB device is played back, there is noise, skipping, or distorted sound.](#)

[A USB device is not recognized.](#)

[Playback does not start.](#)

[A USB device cannot be connected to the USB port.](#)

[Erroneous display.](#)

[An audio file cannot be played.](#)

Network connection

[Cannot connect to the network.](#)

Home network

[Cannot connect to the network.](#)

[Playback does not start, or the player does not automatically proceed to the next track or file.](#)

[The sound skips during playback.](#)

[\[There is no playable file.\] appears.](#)

[Cannot play copyrighted files.](#)

[Cannot select a previously selected track.](#)

[Controller devices or applications on the home network cannot connect to the unit.](#)

[The unit cannot be turned on by devices on a network.](#)

AirPlay

[The unit cannot be found from an iPhone/iPad/iPod touch or iTunes.](#)

[The sound skips during AirPlay playback.](#)

[AirPlay cannot be used.](#)

Music services

[Cannot connect the unit to a service.](#)

[The sound skips.](#)

BLUETOOTH device

[Pairing cannot be done.](#)

[Cannot make a BLUETOOTH connection.](#)

[The sound skips or fluctuates, or the connection is lost.](#)

[The sound of your BLUETOOTH device cannot be heard on the unit.](#)

[Severe humming or noise.](#)

[Cannot control the unit using a Sony | Music Center device.](#)

“BRAVIA” Sync (Control for HDMI)

[The Control for HDMI function does not work properly.](#)

[TV sound cannot be heard from the speakers connected to the unit. \(eARC/ARC\)](#)

Remote control

[The remote control does not function.](#)

If the problem is not solved

[Reverting to the factory default settings](#)

[Resetting sound fields to the default settings](#)

[Customer support websites](#)

Other Information

[Trademarks and Licenses](#)

Front panel

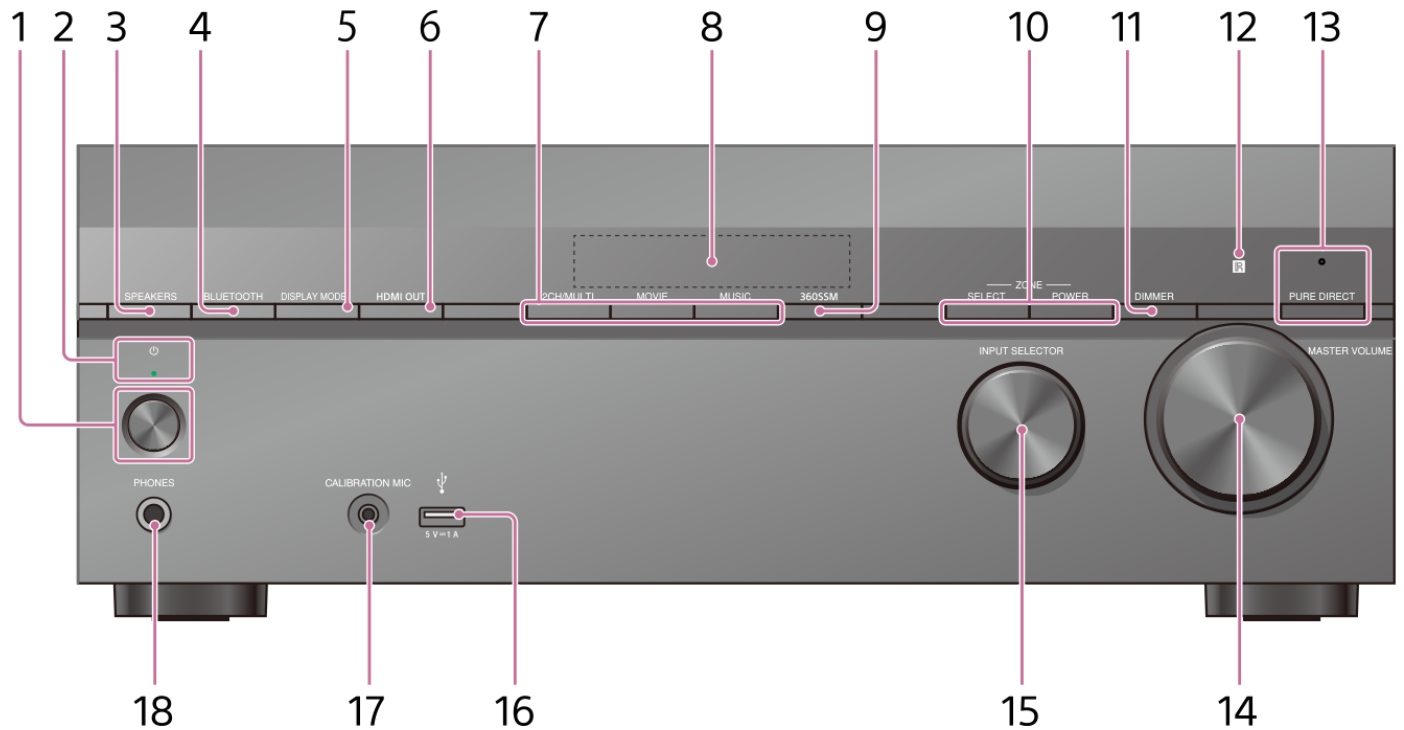

1. ⏻ (power)

2. Power indicator

- Green: The unit is turned on.
- Amber: The unit is in standby mode, and you have set one of the following:
 - [Control for HDMI] or [Network/Bluetooth Standby] is set to [On].
 - [Standby Through] is set to [On] or [Auto].
 - [Power] is set to [On] for [Zone2] or [Zone3].
- The indicator goes off: The unit is in standby mode and you have set all of the following:
 - [Control for HDMI] is set to [Off]
 - [Standby Through] is set to [Off]
 - [Network/Bluetooth Standby] is set to [Off]
 - [Power] for [Zone2] and [Zone3] is set to [Off]

3. SPEAKERS

4. BLUETOOTH

Switches the unit to the BLUETOOTH® function by pressing the button when [Bluetooth Mode] is set to [Receiver]. When the button is pressed and held for more than 2 seconds, the unit enters the pairing mode.

5. DISPLAY MODE

Switches information on the display panel.

6. HDMI OUT

7. 2CH/MULTI, MOVIE, MUSIC

8. Display panel

9. 360SSM

Activates or deactivates the 360 Spatial Sound Mapping function.

10. ZONE SELECT, ZONE POWER

11. DIMMER

Adjusts the brightness of the display panel.

12. Remote control sensor

Receives signals from remote control.

13. PURE DIRECT

The indicator above the button lights up when the Pure Direct function is activated.

14. MASTER VOLUME

15. INPUT SELECTOR

16. ψ (USB) port

Connect a USB device here.

17. CALIBRATION MIC jack

18. PHONES jack

Connect headphones here.

Related Topic

- [Indicators on the display panel](#)
- [Turning on the unit](#)
- [Selecting the front speakers](#)

Indicators on the display panel

US, Canadian, and Asia-Pacific models

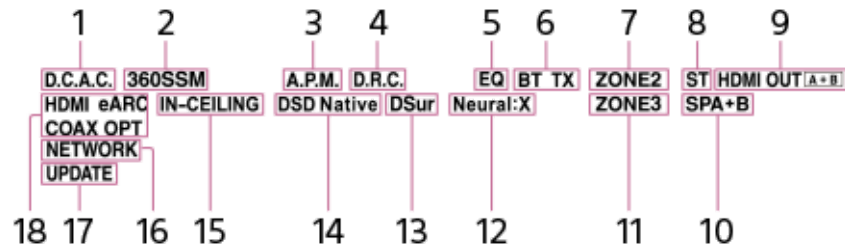

Other countries and region models

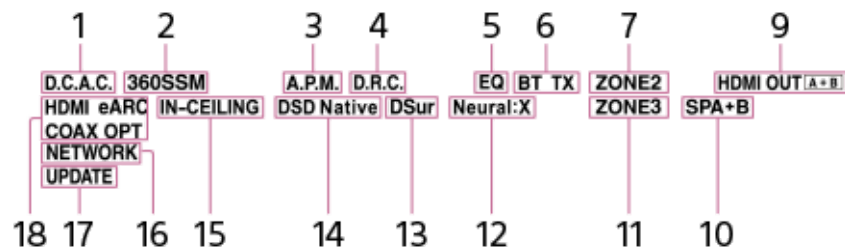

1. D.C.A.C.

Lights up when the measurement results of the D.C.A.C. IX (Digital Cinema Auto Calibration) function are applied.

2. 360SSM

Lights up when the 360 Spatial Sound Mapping function is activated.

3. A.P.M.

Lights up when the A.P.M. (Automatic Phase Matching) function is activated. You can only set the A.P.M. function in the D.C.A.C. IX (Digital Cinema Auto Calibration) function.

4. D.R.C.

Lights up when dynamic range compression is activated.

5. EQ

Lights up when the equalizer is activated.

6. BLUETOOTH indicator

[BT] lights up when a BLUETOOTH device is connected. Flashes while connecting.

[BT TX] lights up when [Bluetooth Mode] is set to [Transmitter].

7. ZONE2

Lights up when the power for Zone 2 is on.

8. ST (for US, Canadian, and Asia-Pacific models only)

Lights up when the unit tunes to an FM stereo broadcast.

9. HDMI OUT A + B

Indicates the HDMI OUT jacks that currently output the audio/video signals.

10. Speaker system indicator

11. ZONE3

Lights up when the power for Zone 3 is on.

12. Neural:X

Lights up when DTS Neural:X decoding is activated.

13. DSur

Lights up when Dolby Surround decoding is activated.

This indicator may not light up depending on the speaker pattern setting.

14. DSD Native

Lights up when the DSD Native function is activated.

15. IN-CEILING

Lights up when the In-Ceiling Speaker Mode is activated.

16. NETWORK

Lights up when the unit is connected to a wireless LAN or wired LAN.

17. UPDATE

Lights up when new software is available.

18. Input indicator

Lights up to indicate the current input signals to the unit.

HDMI

Digital signals are input through the selected HDMI IN jack.

eARC (ARC)

[eARC] lights up when eARC signals are input through the HDMI OUT A (TV) jack, and [ARC] for ARC signals.

COAX

Digital signals are input through the COAXIAL IN SA-CD/CD jack.

OPT

Digital signals are input through the OPTICAL IN TV jack.

Multi Channel AV Receiver/Multi Channel AV Amplifier
STR-AN1000/TA-AN1000

Rear panel

US, Canadian, and Asia-Pacific models

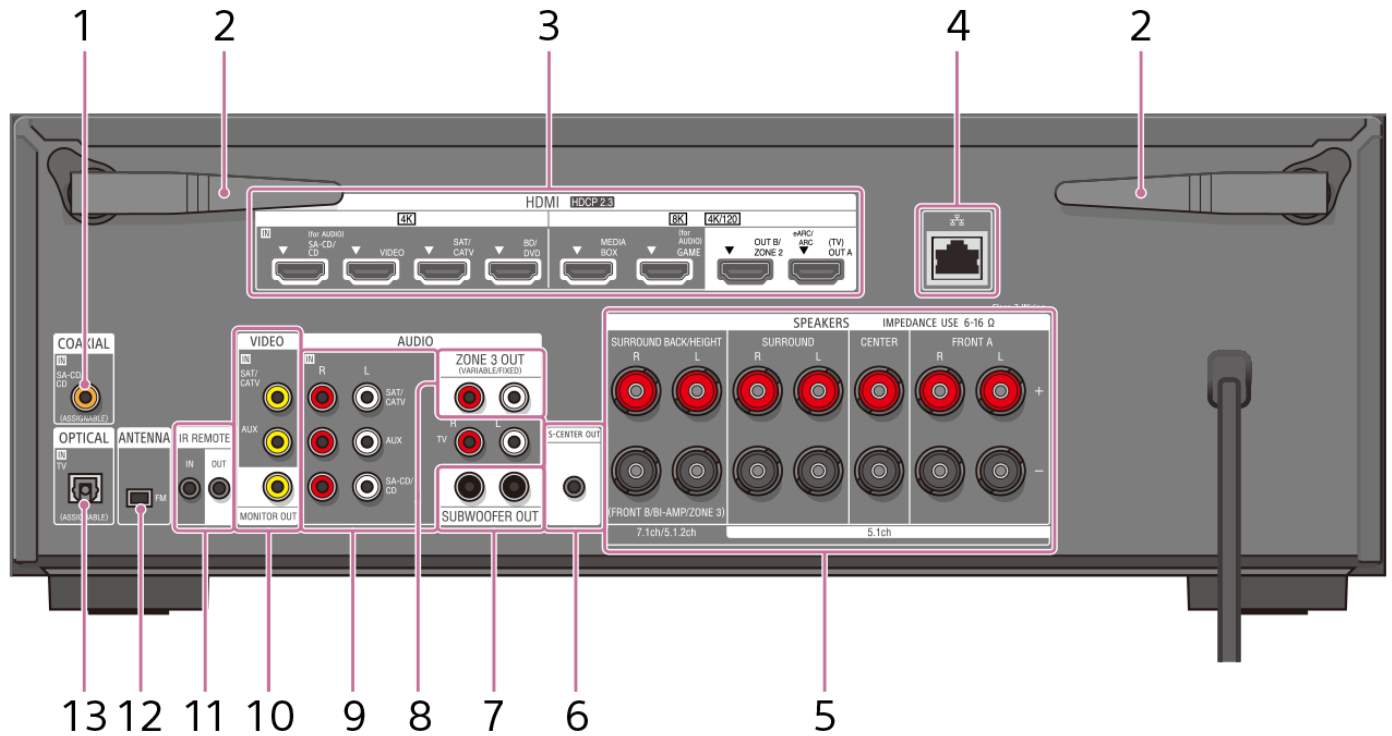

Other countries and region models

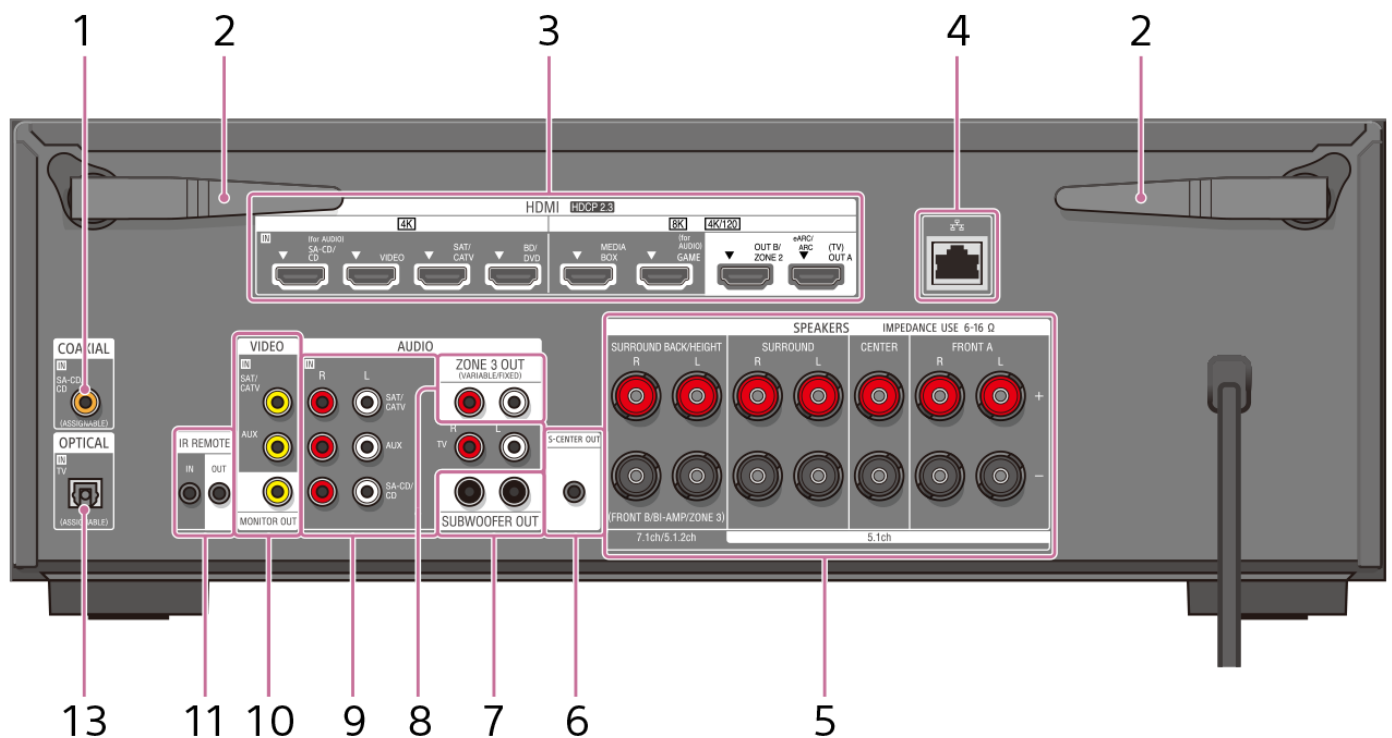

1. COAXIAL IN SA-CD/CD jack

2. Wireless LAN antenna

3. HDMI IN/OUT jacks

4. LAN port

5. SPEAKERS terminals

6. S-CENTER OUT jack

7. SUBWOOFER OUT jacks

8. ZONE 3 OUT jacks

9. AUDIO IN jacks

10. VIDEO IN/MONITOR OUT jacks

11. IR REMOTE IN/OUT jacks

- You can control the unit from a distance by connecting an IR repeater (not supplied) to the IR REMOTE IN jack.
- You can start or stop playback of devices such as a CD player connected to the unit by connecting an IR Blaster (not supplied) to the IR REMOTE OUT jack.

12. FM ANTENNA terminal

13. OPTICAL IN TV jacks

Related Topic

- [About input/output of video signals](#)
- [Connecting a TV compatible with the eARC or ARC function using an HDMI jack](#)
- [Connecting a TV incompatible with the eARC and ARC functions using an HDMI jack](#)
- [Connecting a TV with jacks other than HDMI jacks](#)

Multi Channel AV Receiver/Multi Channel AV Amplifier
STR-AN1000/TA-AN1000

Remote control

Use the supplied remote control to operate this unit.

US, Canadian, and Asia-Pacific models

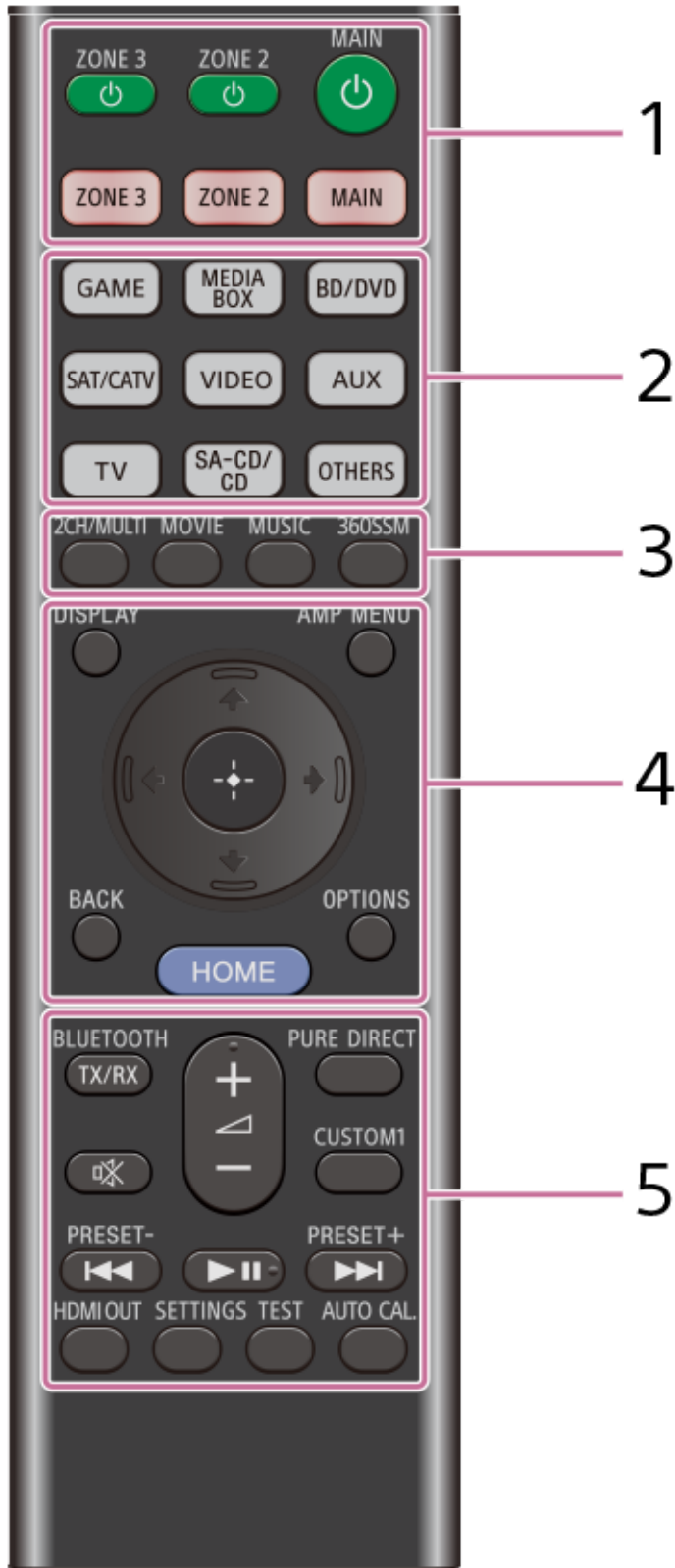

Other countries and region models

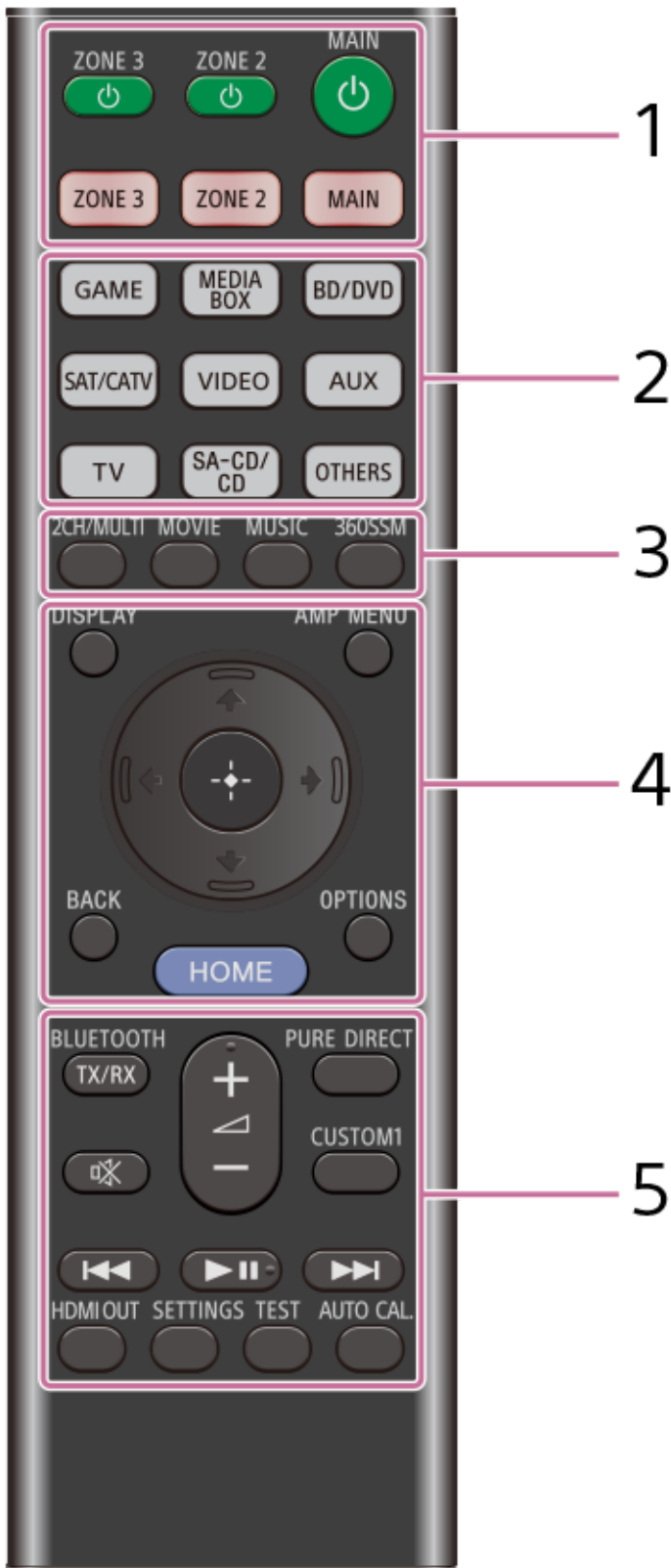

1. (power) (MAIN, ZONE 2, ZONE 3)

Turns the unit in the main zone, Zone 2 or Zone 3 on or sets it to standby mode.

MAIN, ZONE 2, ZONE 3

Selects the location to be controlled. For details, see [“Remote control buttons that can be operated for each zone.”](#)

2. Input buttons

GAME, MEDIA BOX, BD/DVD, SAT/CATV, VIDEO, AUX, TV, SA-CD/CD, OTHERS

Selects the input connected to the device you want to play. When you press any of the input buttons, the unit turns on.

- Press OTHERS button repeatedly to select playback source other than above.

3. 2CH/MULTI, MOVIE (*1), MUSIC (*2)

Select a sound field.

360SSM

Activates or deactivates the 360 Spatial Sound Mapping function.

4. DISPLAY

Displays information on the TV screen.

AMP MENU

Displays the menu on the display panel to operate the unit.

BACK

Returns to the previous menu or exits a menu or on-screen guide that is displayed on the TV screen.

OPTIONS

Displays the options menus. (The menu is not displayed for the TV input.)

▲ (up)/ ▼ (down)/ ◀ (left)/ ▶ (right), ⊕ (enter)

Press ▲ (up)/ ▼ (down)/ ◀ (left)/ ▶ (right) to select the menu items.

Then press ⊕ (enter) to enter the selection.

HOME

Displays the home menu on the TV screen.

5. BLUETOOTH TX/RX

Switches the [Bluetooth Mode] to [Transmitter] or [Receiver].

- In [Transmitter] mode, the unit sends audio to BLUETOOTH headphones/speakers.
- In [Receiver] mode, the unit receives and outputs audio from the remote device.

🔇 (muting)

Turns off the sound temporarily. Press the button again to restore the sound.

PURE DIRECT

Activates or deactivates the Pure Direct function.

CUSTOM1

Saves and recalls various settings for the unit. Press to select the custom preset setting. Press and hold to save the current settings to a preset.

◀ (volume) +(*2)/-

Adjusts the volume level of all speakers at the same time.

◀◀ / ▶▶ (previous/next), ▶▶ (play/pause) (*2)

Skip, play, pause operation.

PRESET +/- (for US, Canadian, and Asia-Pacific models only)

Select preset stations or channels. Press and hold to scan stations automatically.

HDMI OUT

Switches the output for two TVs connected to the HDMI OUT A (TV) and HDMI OUT B/ZONE 2 jacks.

When [HDMI OUT B Mode] is set to [Main] in the [HDMI Settings] menu, output is toggled between [HDMI A], [HDMI B], [HDMI A+B] and [HDMI OFF] each time the button is pressed. When [HDMI OUT B Mode] is set to [Zone2], output is toggled between [HDMI A] and [HDMI OFF] each time the button is pressed.

SETTINGS

Displays the [Setup] menu on the TV screen.

TEST

Displays the [Test Tone] selection screen on the TV screen.

AUTO CAL.

Press to perform Auto Calibration.

*1 The sound fields for movie and music may not work, depending on the input or the speaker pattern you select, or with audio formats.

*2 The ▶▶ (play/pause) and ◀ (volume) + buttons have tactile dots. Use the tactile dots as reference when operating the unit.

Note

- The above explanations are intended to serve as examples.
- Depending on the model of your connected device, some functions explained in this section may not work with the supplied remote control.

Multi Channel AV Receiver/Multi Channel AV Amplifier
STR-AN1000/TA-AN1000

Remote control buttons that can be operated for each zone

| Buttons | Main zone | Zone 2 | Zone 3 |
|--|-----------|---------------|---------------|
| ⏻ (power) buttons ZONE 3, ZONE 2, MAIN | Operable | Operable | Operable |
| Zone select buttons ZONE 3, ZONE 2, MAIN | Operable | Operable | Operable |
| Input selection buttons GAME, MEDIA BOX, BD/DVD, SAT/CATV, VIDEO, AUX, TV, SA-CD/CD, OTHERS | Operable | Operable | Operable |
| Sound field buttons 2CH/MULTI, MOVIE, MUSIC | Operable | Not Operable | Not Operable |
| 360SSM | Operable | Not Operable | Not Operable |
| DISPLAY | Operable | Not Operable | Not Operable |
| AMP MENU | Operable | Not Operable | Not Operable |
| ⬆️ (up)/⬇️ (down)/⬅️ (left)/➡️ (right)/⏏️ (enter) | Operable | Operable (*1) | Operable (*1) |
| BACK | Operable | Operable (*1) | Operable (*1) |
| HOME | Operable | Operable (*1) | Operable (*1) |
| OPTIONS | Operable | Not Operable | Not Operable |
| BLUETOOTH TX/RX | Operable | Not Operable | Not Operable |
| 🔇 (muting) | Operable | Not Operable | Operable |
| 🔊 (volume) +/- | Operable | Not Operable | Operable |
| PURE DIRECT | Operable | Not Operable | Not Operable |
| CUSTOM1 | Operable | Not Operable | Not Operable |

| Buttons | Main zone | Zone 2 | Zone 3 |
|--|-----------|--------------|--------------|
| ▶ (play/pause) | Operable | Not Operable | Not Operable |
| ◀◀ PRESET – (*1)(*2), ▶▶ PRESET + (*1)(*2) | Operable | Not Operable | Operable |
| HDMI OUT | Operable | Not Operable | Not Operable |
| SETTINGS | Operable | Not Operable | Not Operable |
| TEST | Operable | Not Operable | Not Operable |
| AUTO CAL. | Operable | Not Operable | Not Operable |

*1 You can operate the menu on the TV screen in the main zone.

*2 PRESET – and PRESET + are for US, Canadian, and Asia-Pacific models only.

About input/output of video signals

The digital video signals input to the HDMI IN jacks of this unit are output from HDMI OUT A (TV) or HDMI OUT B/ZONE 2 jacks only. The analog video signals input from the VIDEO IN jacks are output from the MONITOR OUT jack only.

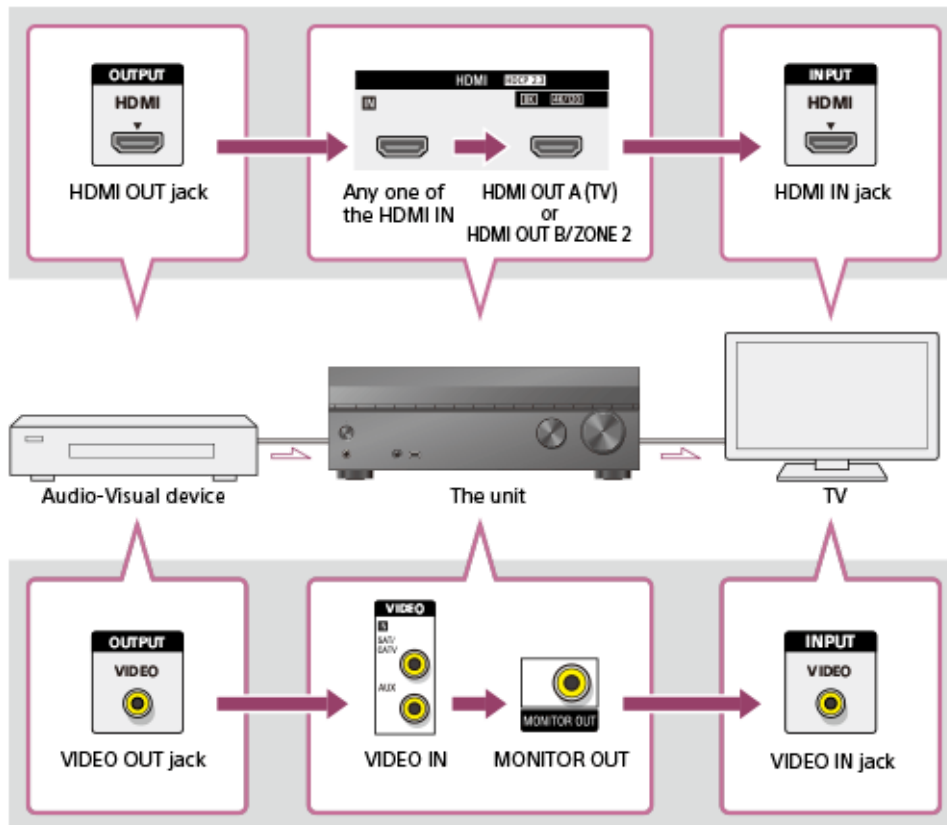

Note

- When you connect the TV to the MONITOR OUT jack, the home menu of this unit is not displayed on the TV screen. To operate this unit using the menu on the TV screen, connect the TV to the HDMI OUT A (TV) or HDMI OUT B/ZONE 2 jacks.

Multi Channel AV Receiver/Multi Channel AV Amplifier
STR-AN1000/TA-AN1000

Playable types of audio files

| Codec | Extension |
|------------------------------|---------------------------------------|
| MP3 (MPEG-1 Audio Layer III) | .mp3 |
| MPEG-H | .mp4 |
| AAC/HE-AAC (*1) | .m4a, .aac (*2), .mp4 (*2), .3gp (*2) |
| WMA9 Standard (*1) | .wma |
| LPCM | .wav |
| FLAC (*1) | .flac |
| DSF (*1) | .dsf |
| DSDIFF (*1) (*3) | .dff |
| AIFF (*1) | .aiff, .aif |
| ALAC (*1) | .m4a |
| Vorbis | .ogg |
| Monkey's Audio | .ape |

*1 The unit may not play this file format on a home network server.

*2 The unit does not play this file format on a home network server.

*3 The unit does not play DST encoded files.

Note

- Some files may not play depending on the file format, the file encoding, the recording condition, or the home network server condition.
- Some files edited on a PC may not play.
- Fast forward or fast reverse may not be available with some files.
- The unit does not play coded files such as DRM.
- The unit cannot recognize a file/folder depending on the name/metadata.
- Some USB devices may not work with this unit.
- The unit can recognize Mass Storage Class (MSC) devices.

Multi Channel AV Receiver/Multi Channel AV Amplifier
STR-AN1000/TA-AN1000

Digital audio formats supported by the unit

The digital audio formats that this unit can decode depend on the digital audio output jacks of the connected device. This unit supports the following audio formats. The words in brackets are those indicated on the display panel.

| Digital audio format | Maximum number of decoding/rendering channels | Connection with the unit |
|---|---|--|
| Dolby Digital [DD] | 5.1 | COAXIAL/OPTICAL, HDMI, eARC, ARC |
| Dolby Digital Plus [DD+] (*1) | 7.1 | HDMI, eARC, ARC |
| Dolby Atmos - Dolby Digital Plus [ATMOS] (*1)(*2) | 5.1.2, 7.1 or 7.1.2 (*5) | HDMI, eARC, ARC |
| DTS [DTS] | 5.1 | COAXIAL/OPTICAL, HDMI, eARC, ARC |
| DTS 96/24 [DTS] | 5.1 | COAXIAL/OPTICAL, HDMI, eARC, ARC |
| LPCM [LPCM] | 7.1/2.0 | COAXIAL/OPTICAL(2.0), HDMI(7.1), eARC(7.1), ARC(2.0) |
| Dolby TrueHD [DTHD] (*1) | 7.1 | HDMI, eARC |
| Dolby Atmos TrueHD [ATMOS] (*1)(*2) | 5.1.2, 7.1 or 7.1.2 (*3) | HDMI, eARC |
| Dolby Atmos [ATMOS] | 5.1.2, 7.1 or 7.1.2 (*3) | HDMI, eARC |
| DTS-ES DISCRETE (DTS-ES Discrete 6.1) [DTS] | 6.1 | COAXIAL/OPTICAL, HDMI, eARC, ARC |
| DTS-ES MATRIX(DTS-ES Matrix 6.1) [DTS] | 6.1 | COAXIAL/OPTICAL, HDMI, eARC, ARC |
| DTS-HD High Resolution Audio [DTS-HD] (*1) | 7.1 | HDMI, eARC |
| DTS-HD Master Audio [DTS-HD] (*1) | 7.1 | HDMI, eARC |
| DTS Express [DTS-HD] | 5.1 | HDMI, eARC |
| DTS:X Master Audio [DTS:X] (*1) | 5.1.2, 7.1 or 7.1.2 (*3) | HDMI, eARC |
| DTS:X [DTS:X] (*1) | 5.1.2, 7.1 or 7.1.2 (*3) | HDMI, eARC |
| DSD [DSD] (*4)(*5) | 5.1 | HDMI |

*1 Audio signals are output in another format if the playback device does not correspond to the actual format. For details, refer to the operating instructions of the playback device.

*2 Dolby Atmos is decoded as Dolby Digital Plus or Dolby TrueHD if the speaker pattern is set to 2.0, 2.1, 3.0, 3.1, 4.0, 4.1, 5.0 or 5.1 and [Virtualizer] is set to [Off].

*3 Available only when [SpeakerRelocation / PhantomSurroundBack] is set to [Type A] or [Type B].

*4 This format is not output to wireless headphones.

*5 This format is not output to wireless speakers.

Video formats supported by the unit

This unit supports the following video formats.

- 8K 60/50/30/25/24 Hz
- 4K 120/100/60/50/30/25/24 Hz
- 1080p 120/100/60/50/30/24 Hz
- 1080i 60/50 Hz
- 720p 60/50/30/24 Hz
- 576p 50 Hz
- 480p 60 Hz

The details of the video formats are as follows.

| Format type | Resolution | Frame rate | Color space | Color depth |
|-----------------------------|--------------|-------------------------------------|--|-------------|
| Enhanced format (4K120, 8K) | 7680 x 4320p | 60/59.94/50/30/29.97/25/24/23.98 Hz | RGB 4:4:4 YCbCr 4:4:4 YCbCr 4:2:2 YCbCr 4:2:0 | 8/10/12 bit |
| Enhanced format (4K120, 8K) | 4096 x 2160p | 120/119.88/100 Hz | RGB 4:4:4 YCbCr 4:4:4 YCbCr 4:2:2 YCbCr 4:2:0 | 8/10/12 bit |
| Enhanced format (4K120, 8K) | 4096 x 2160p | 60/59.94/50 Hz | RGB 4:4:4 YCbCr 4:4:4 | 10/12 bit |
| Enhanced format (4K120, 8K) | 3840 x 2160p | 120/119.88/100 Hz | RGB 4:4:4 YCbCr 4:4:4 YCbCr 4:2:2 YCbCr 4:2:0 | 8/10/12 bit |
| Enhanced format (4K120, 8K) | 3840 x 2160p | 60/59.94/50 Hz | RGB 4:4:4 YCbCr 4:4:4 | 10/12 bit |
| Enhanced format | 4096 x 2160p | 60/59.94/50 Hz | RGB 4:4:4 YCbCr 4:4:4 | 8 bit |
| Enhanced format | 4096 x 2160p | 60/59.94/50 Hz | YCbCr 4:2:2 | 8/10/12 bit |
| Enhanced format | 4096 x 2160p | 60/59.94/50 Hz | YCbCr 4:2:0 | 10/12 bit |
| Enhanced format | 4096 x 2160p | 24/23.98 Hz | RGB 4:4:4 YCbCr 4:4:4 | 10/12 bit |
| Enhanced format | 3840 x 2160p | 60/59.94/50 Hz | RGB 4:4:4 YCbCr 4:4:4 | 8 bit |
| Enhanced format | 3840 x 2160p | 60/59.94/50 Hz | YCbCr 4:2:2 | 8/10/12 bit |
| Enhanced format | 3840 x 2160p | 60/59.94/50 Hz | YCbCr 4:2:0 | 10/12 bit |
| Enhanced format | 3840 x 2160p | 30/29.97/25/24/23.98 Hz | RGB 4:4:4 YCbCr 4:4:4 | 10/12 bit |

| Format type | Resolution | Frame rate | Color space | Color depth |
|-----------------|--------------|----------------------------------|---|-------------|
| Enhanced format | 1920 x 1080p | 120/119.88/100 Hz | RGB 4:4:4 YCbCr 4:4:4 | 10/12 bit |
| Standard format | 4096 x 2160p | 60/59.94/50 Hz | YCbCr 4:2:0 | 8 bit |
| Standard format | 4096 x 2160p | 24/23.98 Hz | RGB 4:4:4 YCbCr 4:4:4 | 8 bit |
| Standard format | 4096 x 2160p | 24/23.98 Hz | YCbCr 4:2:2 | 8/10/12 bit |
| Standard format | 3840 x 2160p | 60/59.94/50 Hz | YCbCr 4:2:0 | 8 bit |
| Standard format | 3840 x 2160p | 30/29.97/25/24/23.98 Hz | RGB 4:4:4 YCbCr 4:4:4 | 8 bit |
| Standard format | 3840 x 2160p | 30/29.97/25/24/23.98 Hz | YCbCr 4:2:2 | 8/10/12 bit |
| Standard format | 1920 x 1080p | 120/119.88/100 Hz | RGB 4:4:4 YCbCr 4:4:4 | 8 bit |
| Standard format | 1920 x 1080p | 120/119.88/100 Hz | YCbCr 4:2:2 | 8/10/12 bit |
| Standard format | 1920 x 1080p | 60/59.94/50/30/29.97/24/23.98 Hz | RGB 4:4:4 YCbCr 4:4:4 YCbCr 4:2:2 | 8/10/12 bit |
| Standard format | 1920 x 1080p | 60/59.94/50 Hz | RGB 4:4:4 YCbCr 4:4:4 YCbCr 4:2:2 | 8/10/12 bit |
| Standard format | 1280 x 720p | 60/59.94/50/30/29.97/24/23.98 Hz | RGB 4:4:4 YCbCr 4:4:4 YCbCr 4:2:2 | 8/10/12 bit |
| Standard format | 720 x 480p | 60/59.94 Hz | RGB 4:4:4 YCbCr 4:4:4 YCbCr 4:2:2 | 8/10/12 bit |
| Standard format | 720 x 576p | 50 Hz | RGB 4:4:4 YCbCr 4:4:4 YCbCr 4:2:2 | 8/10/12 bit |
| Standard format | 640 x 480p | 60/59.94 Hz | RGB 4:4:4 | 8/10/12 bit |

About [HDMI Signal Format] setting

- When [HDMI Signal Format] is set to [Enhanced format (4K120, 8K)], the unit can receive the video format of “Enhanced format (4K120, 8K),” “Enhanced format” or “Standard format” in “Format type.”
- When [HDMI Signal Format] is set to [Enhanced format], the unit can receive the video format of “Enhanced format” or “Standard format” in “Format type.”
- When [HDMI Signal Format] is set to [Standard format], the unit can receive the video format of “Standard format” in “Format type.”

About the HDMI cable you use

Be sure to use a Premium High Speed HDMI Cable with Ethernet, which supports bandwidths up to 18 Gbps. For video signals that require a high bandwidth such as “Enhanced format (4K120, 8K)” in “Format type,” be sure to use an Ultra High Speed HDMI Cable that supports bandwidths up to 48 Gbps.

About 3D signals

- The following video formats support 3D signals of the side-by-side split method.

- Resolution 1920 x 1080i, frame rate 50/59.94/60 Hz, color space RGB 4:4:4/YCbCr 4:4:4/YCbCr 4:2:2, color depth 8/10/12 bit
- The following video formats support 3D signals of the frame packing and top-and-bottom split method.
 - Resolution 1920 x 1080p, frame rate 23.98/24 Hz, color space RGB 4:4:4/YCbCr 4:4:4/YCbCr 4:2:2, color depth 8/10/12 bit
 - Resolution 1280 x 720p, frame rate 50/59.94/60 Hz, color space RGB 4:4:4/YCbCr 4:4:4/YCbCr 4:2:2, color depth 8/10/12 bit

About compressed video signals

The following video formats only support compressed video signals.

- Resolution 8K 7680 x 4320p, frame rate 50/59.94/60 Hz, color space RGB 4:4:4/YCbCr 4:4:4/YCbCr 4:2:2, color depth 8/10/12 bit
- Resolution 8K 7680 x 4320p, frame rate 50/59.94/60 Hz, color space YCbCr 4:2:0, color depth 12 bit
- Resolution 8K 7680 x 4320p, frame rate 23.98/24/25/29.97/30 Hz, color space RGB 4:4:4/YCbCr 4:4:4, color depth 12 bit
- Resolution 4K 4096 x 2160p/3840 x 2160p, frame rate 100/119.88/120 Hz, color space RGB 4:4:4/YCbCr 4:4:4, color depth 12 bit

About OPTIONS and on-screen display (OSD)

In the case of the following signals, OPTIONS does not work. In addition, the on-screen display (OSD) is not displayed.

- Signal with a resolution of 4096 x 2160p
- 3D signals of the side-by-side or top-and-bottom split method
- VRR signals and compressed video signals

Multi Channel AV Receiver/Multi Channel AV Amplifier
STR-AN1000/TA-AN1000

Notes on connecting cables

- Before connecting cables, be sure to disconnect the AC power cord (mains lead).
- It is not necessary to connect all of the cables. Connect cables according to the availability of jacks on the connected device.
- For HDMI cables, be sure to use a Premium High Speed HDMI Cable with Ethernet, which supports bandwidths up to 18 Gbps. For video signals that require a high bandwidth such as 4K/120p, 8K, etc., be sure to use an Ultra High Speed HDMI Cable that supports bandwidths up to 48 Gbps. For details about the high bandwidth video format, refer to "[Video formats supported by the unit.](#)"
- We do not recommend using an HDMI-DVI conversion cable. If you connect an HDMI-DVI conversion cable to a DVI-D device, the sound and/or image may be lost. Connect separate audio cables or digital connecting cables, then reassign the input jacks if the sound is not output correctly.
- When connecting optical digital cables, insert the plugs straight until they click into place.
- Do not bend or tie optical digital cables.

Hint

- All of the digital audio jacks are compatible with 32 kHz, 44.1 kHz, 48 kHz and 96 kHz sampling frequencies.

If you want to connect several digital devices, but cannot find an unused input

In this case, reassign the input jacks.

Related Topic

- [About HDMI connections](#)
- [Using other digital audio input jacks \(Input Assign\)](#)
- [Setting HDMI signal formats \(HDMI Signal Format\)](#)

Multi Channel AV Receiver/Multi Channel AV Amplifier
STR-AN1000/TA-AN1000

About HDMI connections

High-Definition Multimedia Interface (HDMI) is an interface that transmits video and audio signals in digital format. Connecting Sony "BRAVIA" Sync-compatible devices using HDMI cables simplifies operations.

HDMI features

- Digital audio signals transmitted by HDMI can be output from the speakers connected to the unit. This signal supports Dolby Digital, DTS, DSD, and Linear PCM.
- The unit can receive Multi Channel Linear PCM (up to 8 channels) with a sampling frequency of 192 kHz or less via an HDMI connection.
- The unit also supports DTS-HD Master Audio, Dolby TrueHD and object-based audio formats (DTS:X and Dolby Atmos).
- The eARC/ARC function allows you to receive the TV's audio signal.
- To enjoy 3D content, connect a 3D-compatible TV and video device (Blu-ray Disc player, Blu-ray Disc recorder, etc.) to the unit using High Speed HDMI Cables with Ethernet.
- For HDMI cables, be sure to use a Premium High Speed HDMI Cable with Ethernet, which supports bandwidths up to 18 Gbps. For video signals that require a high bandwidth such as 4K/120p, 8K, etc., be sure to use an Ultra High Speed HDMI Cable that supports bandwidths up to 48 Gbps.
- The HDMI jacks on the unit support the following standards and functions:
 - All HDMI jacks on the unit support High-bandwidth Digital Content Protection System Revision 2.3 (HDCP 2.3). Connect these HDMI jacks to jacks that support HDCP 2.2 or HDCP 2.3 on the TV and AV device. Refer to the operating instructions of the connected device for details.
 - All HDMI jacks support wide color gamut compliant with the ITU-R BT.2020 standard.
 - All HDMI jacks support transmission of Deep Color (Deep Colour), HDR (High Dynamic Range), and 3D video signals.
 - The HDMI IN GAME (for AUDIO) jack, HDMI IN MEDIA BOX jack, HDMI OUT A (TV) jack, and OUT B/ZONE 2 jack support transmission of video signals up to 4K/120p and 8K, compressed video, VRR, and ALLM signals.
 - The HDMI IN BD/DVD jack, HDMI IN SAT/CATV jack, HDMI IN VIDEO jack, and HDMI IN SA-CD/CD (for AUDIO) jack support transmission of video signals up to 4K/60p.
- HDCP 2.3 is newly enhanced copyright protection technology that is used to protect content such as 4K/8K movies.
- BT.2020 color space is wider color standard that is defined for ultra-high definition television systems.
- HDR is a video format that can display a wider range of brightness levels. The unit supports HDR10, HLG (Hybrid Log-Gamma), and Dolby Vision.
- VRR (Variable Refresh Rate) is a video transmission method that suppresses video clogging and enables smooth display by adjusting the refresh rate on the display side according to the frame rate of TV game, etc.
- ALLM (Auto Low Latency Mode) is a function that automatically switches to low latency mode in conjunction with the output of TV game, etc.

Note

- Depending on the TV or video device, 4K or 3D content may not be displayed. Check the HDMI video formats supported by the unit.
- When you connect two TVs to the unit, Dolby Vision content may not be displayed. For details, see "[Switching the TVs that output the HDMI video signals.](#)"
- Refer to the operating instructions of each connected device for details.

Related Topic

- [Connecting devices with HDMI jacks](#)
- [Digital audio formats supported by the unit](#)
- [Switching the TVs that output the HDMI video signals](#)

Speaker installation example

You can connect up to 7 speakers and 2 subwoofers to this unit. Place the speakers and subwoofers according to the speaker system of your preference.

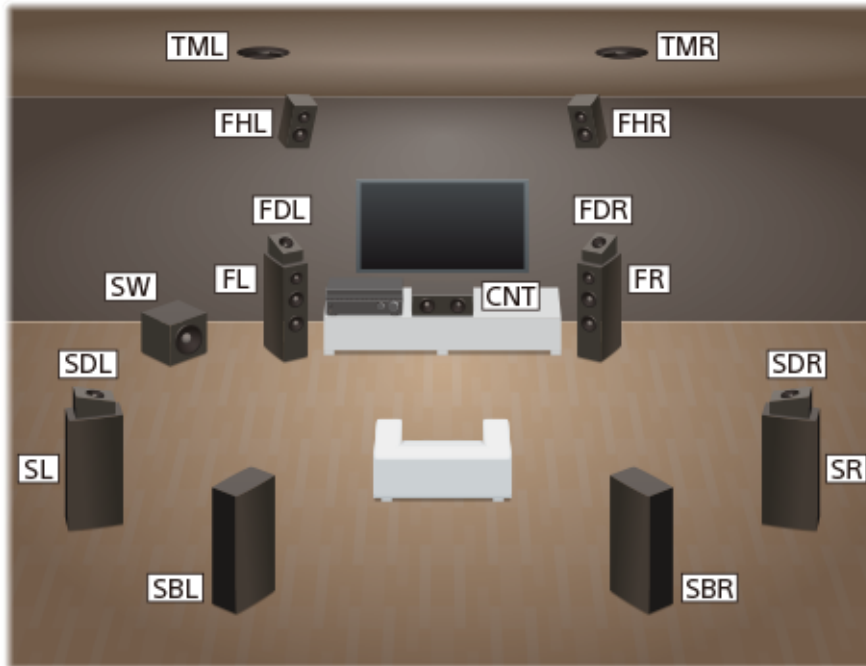

Hint

- As the subwoofer (SW) does not emit highly directional signals, you can place it wherever you want.

| Abbreviations used in illustrations | Speaker name | Functions |
|-------------------------------------|-----------------------------|---|
| FL | Front left speaker | Produces sounds from front left channel. |
| FR | Front right speaker | Produces sounds from front right channel. |
| CNT | Center speaker | Produces vocal sounds from center channel. |
| SL | Surround left speaker | Produces sounds from surround left channel. |
| SR | Surround right speaker | Produces sounds from surround right channel. |
| SBL | Surround back left speaker | Produces sounds from surround back left channel. |
| SBR | Surround back right speaker | Produces sounds from surround back right channel. |
| SW | Subwoofer | Produces LFE (low frequency effect) channel sounds and reinforces bass parts of other channels. |
| TML | Top middle left speaker | Produces sounds from top middle left channel. |

| Abbreviations used in illustrations | Speaker name | Functions |
|-------------------------------------|--|---|
| TMR | Top middle right speaker | Produces sounds from top middle right channel. |
| FDL | Front Dolby Atmos enabled left speaker | Produces sounds from the top middle left channel and reflects these sounds off the ceiling. Enables playing back sounds of Dolby Atmos 3D movies without the need to install ceiling speakers. |
| FDR | Front Dolby Atmos enabled right speaker | Produces sounds from the top middle right channel and reflects these sounds off the ceiling. Enables playing back sounds of Dolby Atmos 3D movies without the need to install ceiling speakers. |
| SDL | Surround Dolby Atmos enabled left speaker | Produces sounds from the top middle left channel and reflects these sounds off the ceiling. Enables playing back sounds of Dolby Atmos 3D movies without the need to install ceiling speakers. |
| SDR | Surround Dolby Atmos enabled right speaker | Produces sounds from the top middle right channel and reflects these sounds off the ceiling. Enables playing back sounds of Dolby Atmos 3D movies without the need to install ceiling speakers. |
| FHL | Front height left speaker | Produces vertical sound effects from Front height left channel. |
| FHR | Front height right speaker | Produces vertical sound effects from Front height right channel. |

Related Topic

- [Installing 5.1-channel speaker system with Zone 3 connection](#)

Speaker configuration and speaker pattern settings

This unit allows you to connect up to a 7.1-channel system. The table below shows examples of speaker configurations and speaker pattern settings.

| Speaker configuration in each zone | | [Surround Back Speaker Assign] | [Speaker Pattern] setting |
|--|-----------|--------------------------------|---------------------------|
| Main zone | Zone 3 | | |
| 5.1-channel | Not used | [Off] | [5.1] |
| 7.1-channel using surround back speakers | Not used | Not available | [7.1] |
| 5.1.2-channel using top middle speakers | Not used | Not available | [5.1.2 (TM)] |
| 5.1.2-channel using Dolby Atmos enabled speakers | Not used | Not available | [5.1.2 (FD)] |
| 5.1-channel with Zone 3 connection | 2-channel | [Zone3] | [5.1] |
| 5.1-channel with bi-amplifier connection | Not used | [BI-AMP] | [5.1] |
| 5.1-channel with front B speaker connection | Not used | [Front B] | [5.1] |

* You can only set [Surround Back Speaker Assign] if the speaker pattern is set to a setting that does not have surround back and height speakers.

Hint

- This unit allows you to connect Sony wireless rear speakers and a Sony subwoofer.
- When your Sony TV has the S-CENTER SPEAKER IN jack, you can output the center part of the unit sound from the TV speaker.
- By setting [SpeakerRelocation / PhantomSurroundBack] to [Type A] or [Type B] in the [Audio Settings] menu, you can enjoy a surround effect equivalent to up to 7.1.2 channels in terms of hearing. When you set [SpeakerRelocation / PhantomSurroundBack], perform Auto Calibration in advance.

Related Topic

- [Selecting the speaker pattern \(Speaker Pattern\)](#)
- [Assigning the surround back speaker terminals \(Surround Back Speaker Assign\)](#)
- [Connecting 5.1-channel speaker system](#)
- [Connecting 7.1-channel speaker system using surround back speakers](#)
- [Connecting 5.1.2-channel speaker system using top middle speakers](#)
- [Connecting 5.1.2-channel speaker system using front Dolby Atmos enabled speakers](#)
- [Connecting 5.1-channel speaker system with Zone 3 connection](#)
- [Connecting 5.1-channel speaker system with bi-amplifier connection](#)
- [Connecting 5.1-channel speaker system with front B speaker connection](#)
- [Connecting Sony wireless rear speakers/subwoofer](#)
- [When your TV has the S-CENTER SPEAKER IN jack](#)

Multi Channel AV Receiver/Multi Channel AV Amplifier
STR-AN1000/TA-AN1000

Installing 5.1-channel speaker system

To fully enjoy theater-like multi-channel surround sound, you need five speakers (two front speakers, a center speaker, and two surround speakers) and a subwoofer.

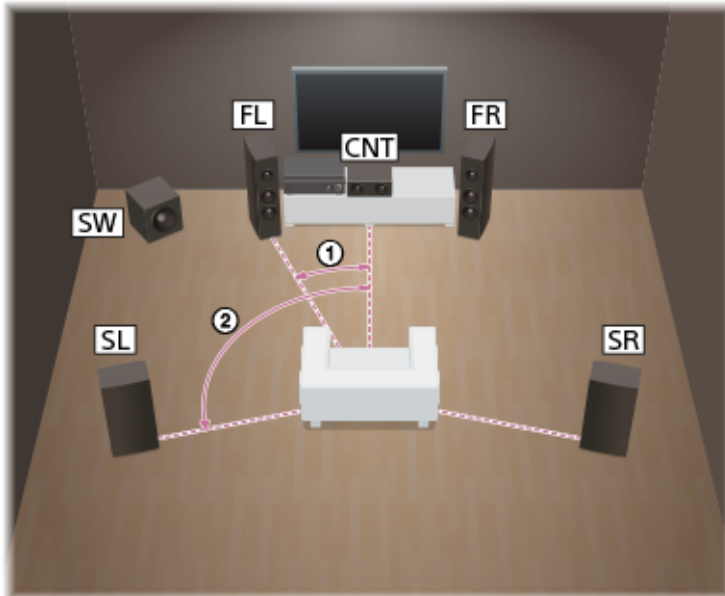

Angle at which each speaker is placed from the line connecting the listening position and the center speaker (0 degrees)

- ① Front speakers: 30°
- ② Surround speakers: 100° - 120°

Hint

- As the subwoofer does not emit highly directional signals, you can place it wherever you want.

Related Topic

- [Speaker installation example](#)
- [Connecting 5.1-channel speaker system](#)

Multi Channel AV Receiver/Multi Channel AV Amplifier
STR-AN1000/TA-AN1000

Installing 7.1-channel speaker system using surround back speakers

You can enjoy high-fidelity reproduction of recorded sound from Blu-ray Disc software in 7.1-channel format.

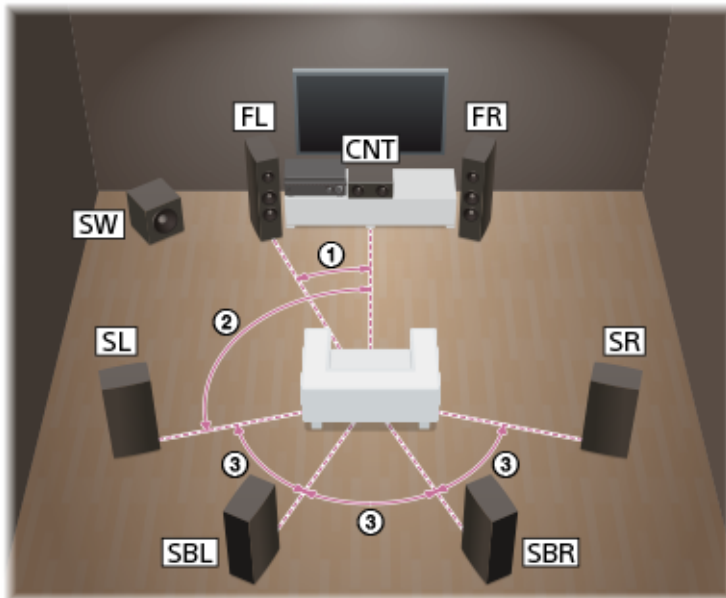

Angle at which each speaker is placed from the line connecting the listening position and the center speaker (0 degrees)

- ① Front speakers: 30°
- ② Surround speakers: 100° - 120°
- ③ Speaker spacings: Same angle

Hint

- As the subwoofer does not emit highly directional signals, you can place it wherever you want.

Related Topic

- [Speaker installation example](#)
- [Connecting 7.1-channel speaker system using surround back speakers](#)

Installing 5.1.2-channel speaker system using top middle speakers

You can enjoy vertical surround effects by connecting additional two top middle speakers.

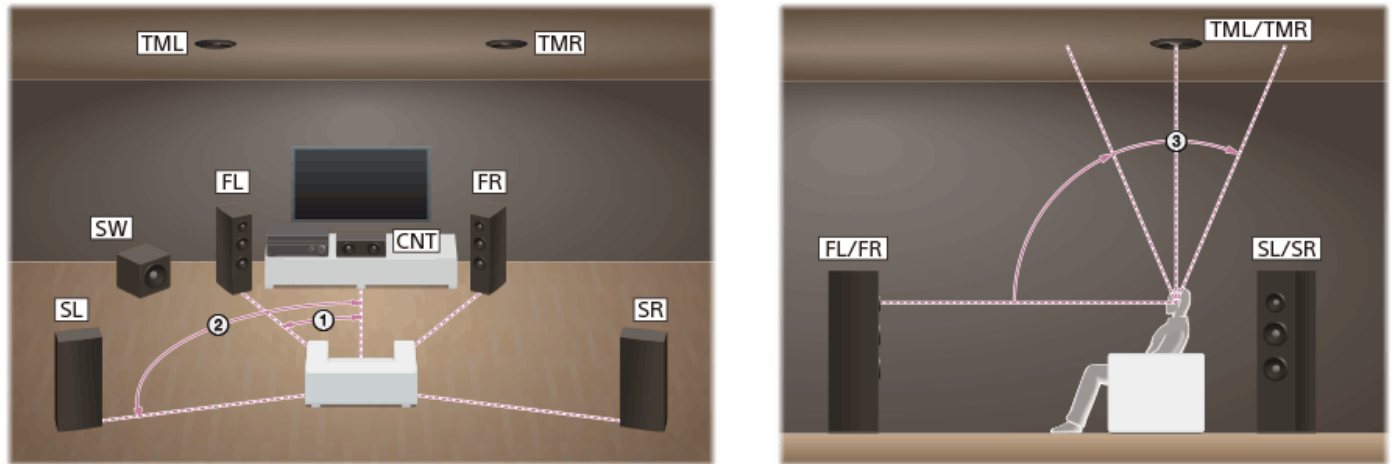

Angle at which each speaker is placed from the line connecting the listening position and the center speaker (0 degrees)

- ① Front speakers: 30°
- ② Surround speakers: 100° - 120°

Vertical angle at which each speaker is placed from a line drawn straight ahead from the height of the listener's ears (0 degrees)

- ③ Top middle speakers: 70° - 110°

Hint

- As the subwoofer does not emit highly directional signals, you can place it wherever you want.

Related Topic

- [Speaker installation example](#)
- [Connecting 5.1.2-channel speaker system using top middle speakers](#)

Multi Channel AV Receiver/Multi Channel AV Amplifier
STR-AN1000/TA-AN1000

Installing 5.1.2-channel speaker system using front Dolby Atmos enabled speakers

You can enjoy vertical surround effects by connecting additional two front Dolby Atmos enabled speakers.

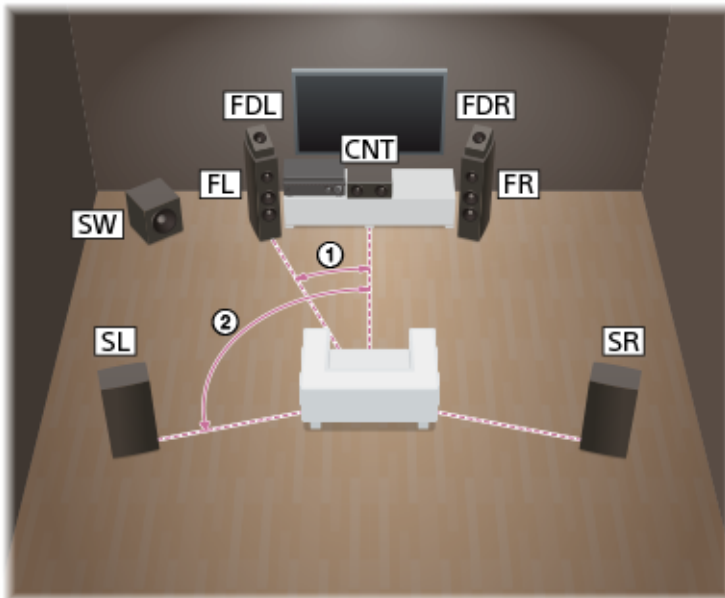

Angle at which each speaker is placed from the line connecting the listening position and the center speaker (0 degrees)

- ① Front Dolby Atmos enabled speakers: 30°
- ② Surround speakers: 100° - 120°

Hint

- As the subwoofer does not emit highly directional signals, you can place it wherever you want.

Related Topic

- [Speaker installation example](#)
- [Connecting 5.1.2-channel speaker system using front Dolby Atmos enabled speakers](#)

Multi Channel AV Receiver/Multi Channel AV Amplifier
STR-AN1000/TA-AN1000

Installing 5.1-channel speaker system with Zone 3 connection

To fully enjoy theater-like multi-channel surround sound, you need five speakers (two front speakers, a center speaker, and two surround speakers) and a subwoofer. You can also enjoy the audio in another location ("Zone 3") by connecting additional Zone 3 speakers. For example, you can watch a DVD in the main zone and listen to a CD in Zone 3.

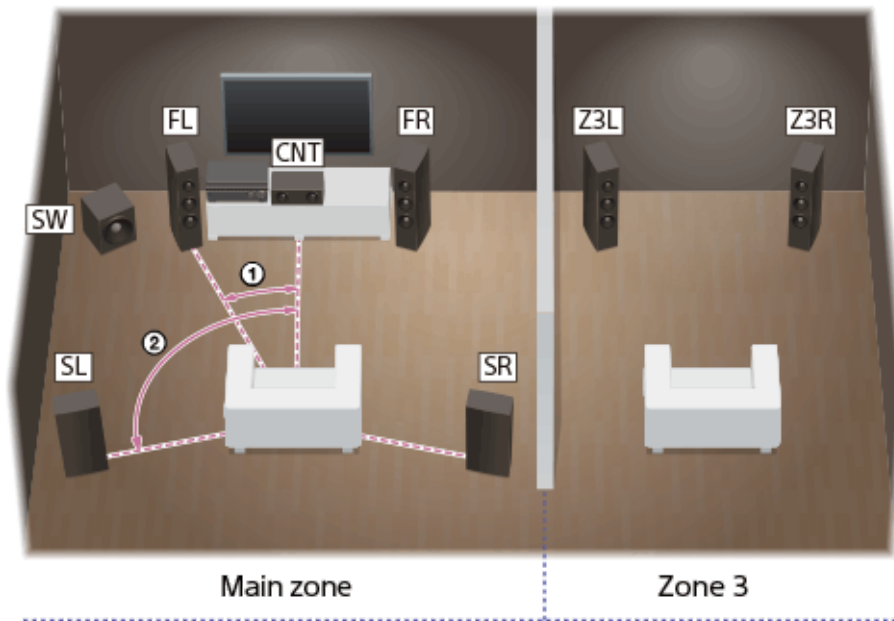

Angle at which each speaker is placed from the line connecting the listening position and the center speaker (0 degrees)

- ① Front speakers: 30°
- ② Surround speakers: 100-120°

Hint

- As the subwoofer does not emit highly directional signals, you can place it wherever you want.

Related Topic

- [Speaker installation example](#)
- [Connecting 5.1-channel speaker system with Zone 3 connection](#)

Multi Channel AV Receiver/Multi Channel AV Amplifier
STR-AN1000/TA-AN1000

Installing 5.1-channel speaker system with bi-amplifier connection

When the front speakers are Bi-wire speakers, which are equipped with separate terminals for high-frequency sounds (tweeter) and low-frequency sounds (woofer), you can make the bi-amplifier connection. You can enjoy higher quality sound playback if you operate the tweeter and woofer using separate amplifiers.

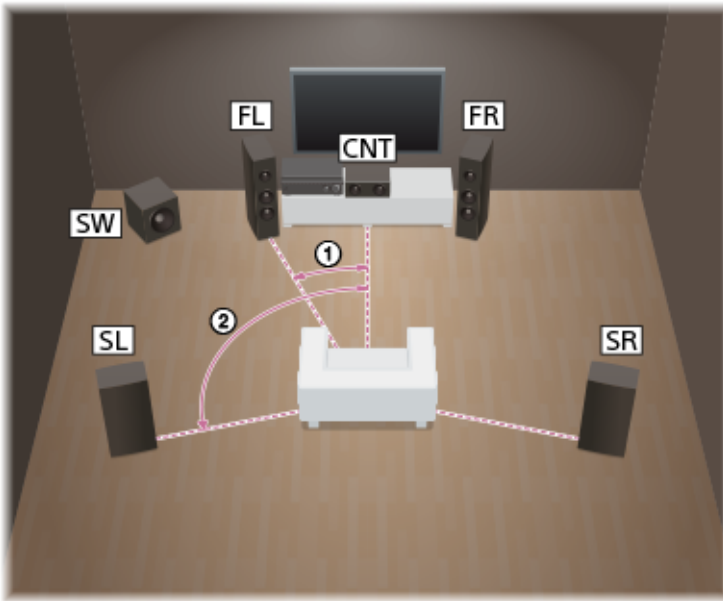

Angle at which each speaker is placed from the line connecting the listening position and the center speaker (0 degrees)

- ① Front speakers: 30°
- ② Surround speakers: 100° - 120°

Hint

- As the subwoofer does not emit highly directional signals, you can place it wherever you want.

Related Topic

- [Speaker installation example](#)
- [Connecting 5.1-channel speaker system with bi-amplifier connection](#)

Multi Channel AV Receiver/Multi Channel AV Amplifier
STR-AN1000/TA-AN1000

Installing 5.1-channel speaker system with front B speaker connection

If you have an additional front speaker system, connect it to SPEAKERS SURROUND BACK/HEIGHT (FRONT B/BI-AMP/ZONE 3) terminals.

You can output sound from either front A speakers or front B speakers, or both front A speakers and front B speakers.

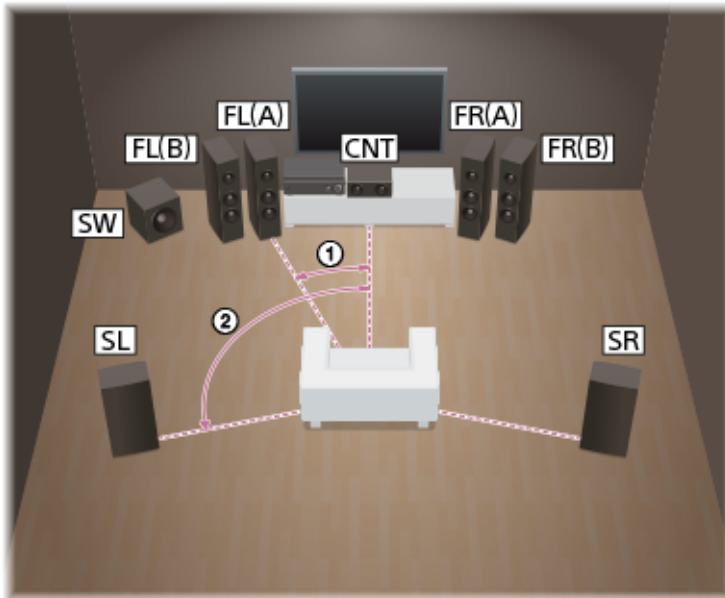

Angle at which each speaker is placed from the line connecting the listening position and the center speaker (0 degrees)

- ① Front speakers: 30°
- ② Surround speakers: 100° - 120°

Hint

- As the subwoofer does not emit highly directional signals, you can place it wherever you want.

Related Topic

- [Speaker installation example](#)
- [Connecting 5.1-channel speaker system with front B speaker connection](#)
- [Selecting the front speakers](#)

Multi Channel AV Receiver/Multi Channel AV Amplifier
STR-AN1000/TA-AN1000

How to connect speaker cables

Be sure to connect the speaker cables correctly to the terminals of the speaker and this unit. Also, be sure to tightly twist the speaker wire strands and insert them securely into the speaker terminals.

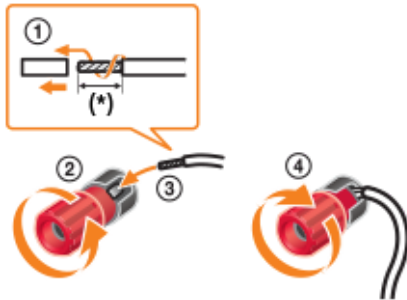

* Strip the jacket to 10 mm (13/32 in) at each end of the speaker cables.

Note

- Be sure not to remove too much of the speaker cable sleeves, so as to prevent the wires of the speaker cables from touching each other.
- Connect speaker cables properly with the polarities (+/-) matched between the unit and the speakers.



- Improper connection may result in fatal damage to the unit.

Multi Channel AV Receiver/Multi Channel AV Amplifier
STR-AN1000/TA-AN1000

Using an active subwoofer

- When you connect a subwoofer with an auto standby function, turn off the function when watching movies. If the auto standby function is set to on, it turns to standby mode automatically based on the level of the input signal to the subwoofer, and the sound may not be output.
- If you have two subwoofers, you can connect them to both SUBWOOFER OUT jacks.

Connecting 5.1-channel speaker system

Connect each speaker to the SPEAKERS terminals on the rear of the unit.
Before connecting cables, be sure to disconnect the AC power cord (mains lead).
For details on how to connect speaker cables to the unit, see [“How to connect speaker cables.”](#)

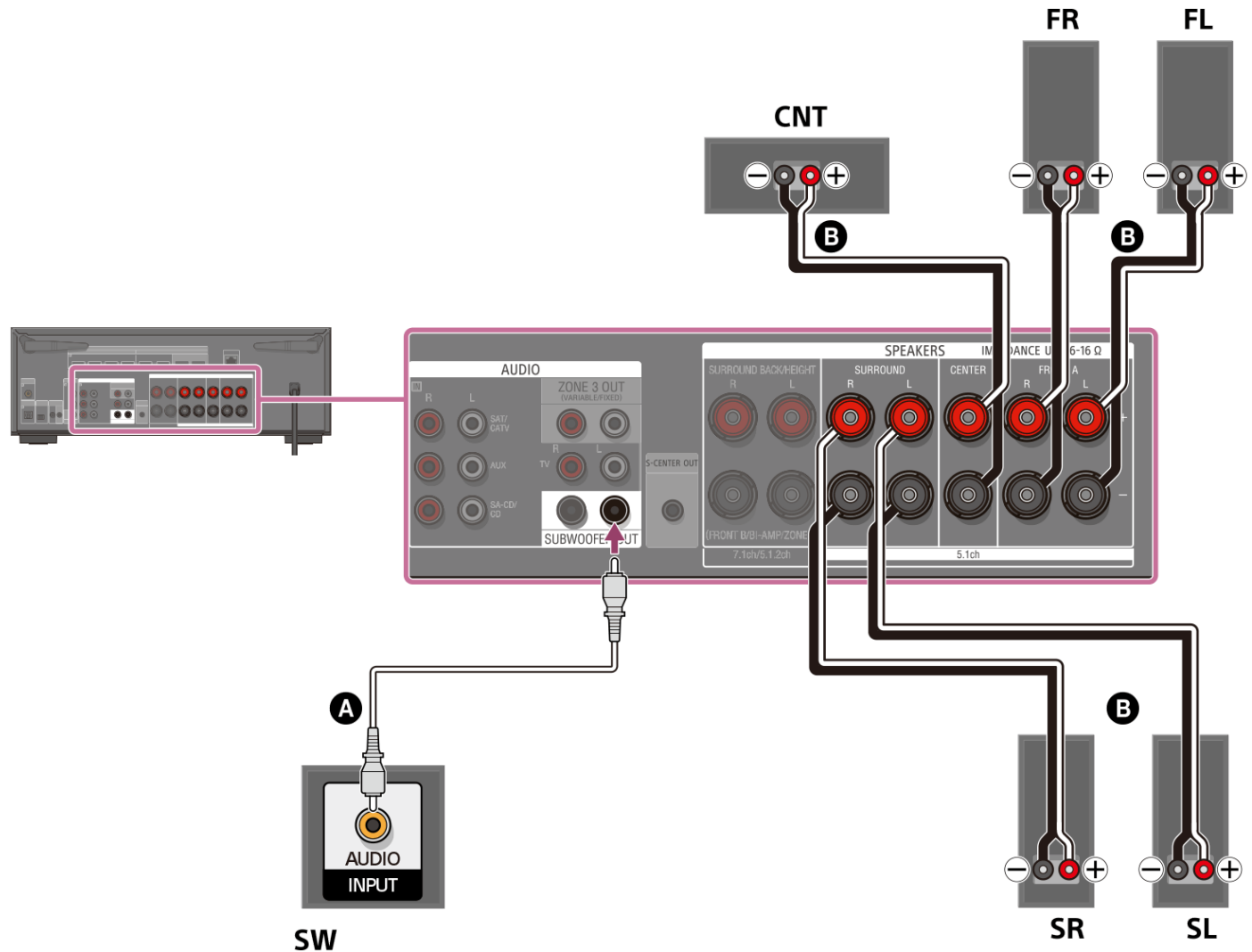

- A** Monaural audio cable (not supplied)
- B** Speaker cable (not supplied)

Note

- Connect speakers with a nominal impedance of 6 ohms to 16 ohms.
- After you have installed and connected your speakers, be sure to select the speaker pattern you want using [Speaker Pattern] in [Manual Speaker Settings] under [Speaker Settings].

Related Topic

- [Speaker installation example](#)
- [Installing 5.1-channel speaker system](#)
- [Selecting the speaker pattern \(Speaker Pattern\)](#)

- [Notes on connecting cables](#)
- [How to connect speaker cables](#)

5-037-030-11(5) Copyright 2022 Sony Corporation

Connecting 7.1-channel speaker system using surround back speakers

Connect each speaker to the SPEAKERS terminals on the rear of the unit.
Before connecting cables, be sure to disconnect the AC power cord (mains lead).
For details on how to connect speaker cables to the unit, see [“How to connect speaker cables.”](#)

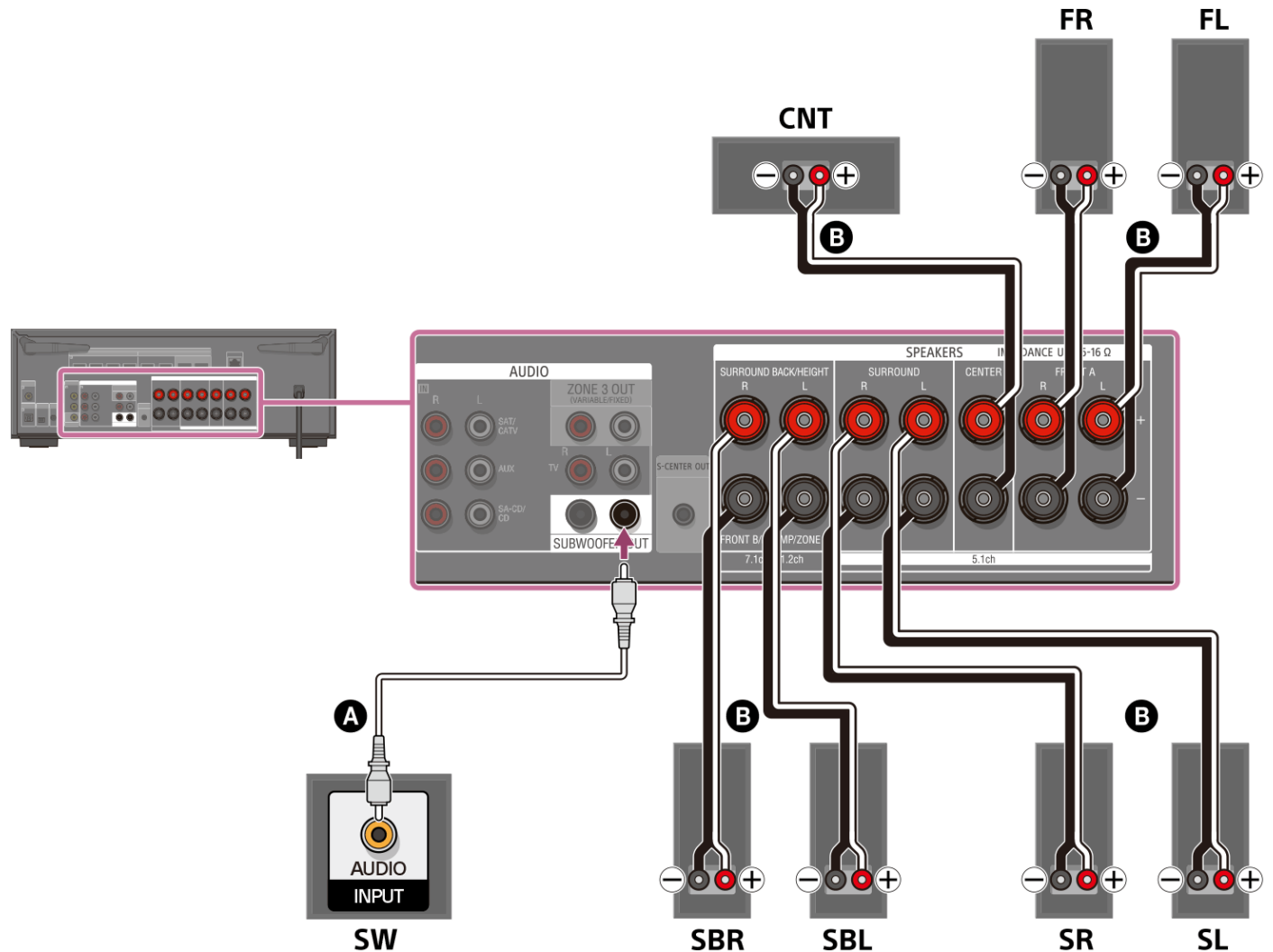

- A** Monaural audio cable (not supplied)
- B** Speaker cable (not supplied)

Note

- Connect speakers with a nominal impedance of 6 ohms to 16 ohms.
- After you have installed and connected your speakers, be sure to select the speaker pattern you want using [Speaker Pattern] in [Manual Speaker Settings] under [Speaker Settings].

Related Topic

- [Speaker installation example](#)
- [Installing 7.1-channel speaker system using surround back speakers](#)
- [Selecting the speaker pattern \(Speaker Pattern\)](#)

- [Notes on connecting cables](#)
- [How to connect speaker cables](#)

5-037-030-11(5) Copyright 2022 Sony Corporation

Connecting 5.1.2-channel speaker system using top middle speakers

Connect each speaker to the SPEAKERS terminals on the rear of the unit.
Before connecting cables, be sure to disconnect the AC power cord (mains lead).
For details on how to connect speaker cables to the unit, see [“How to connect speaker cables.”](#)

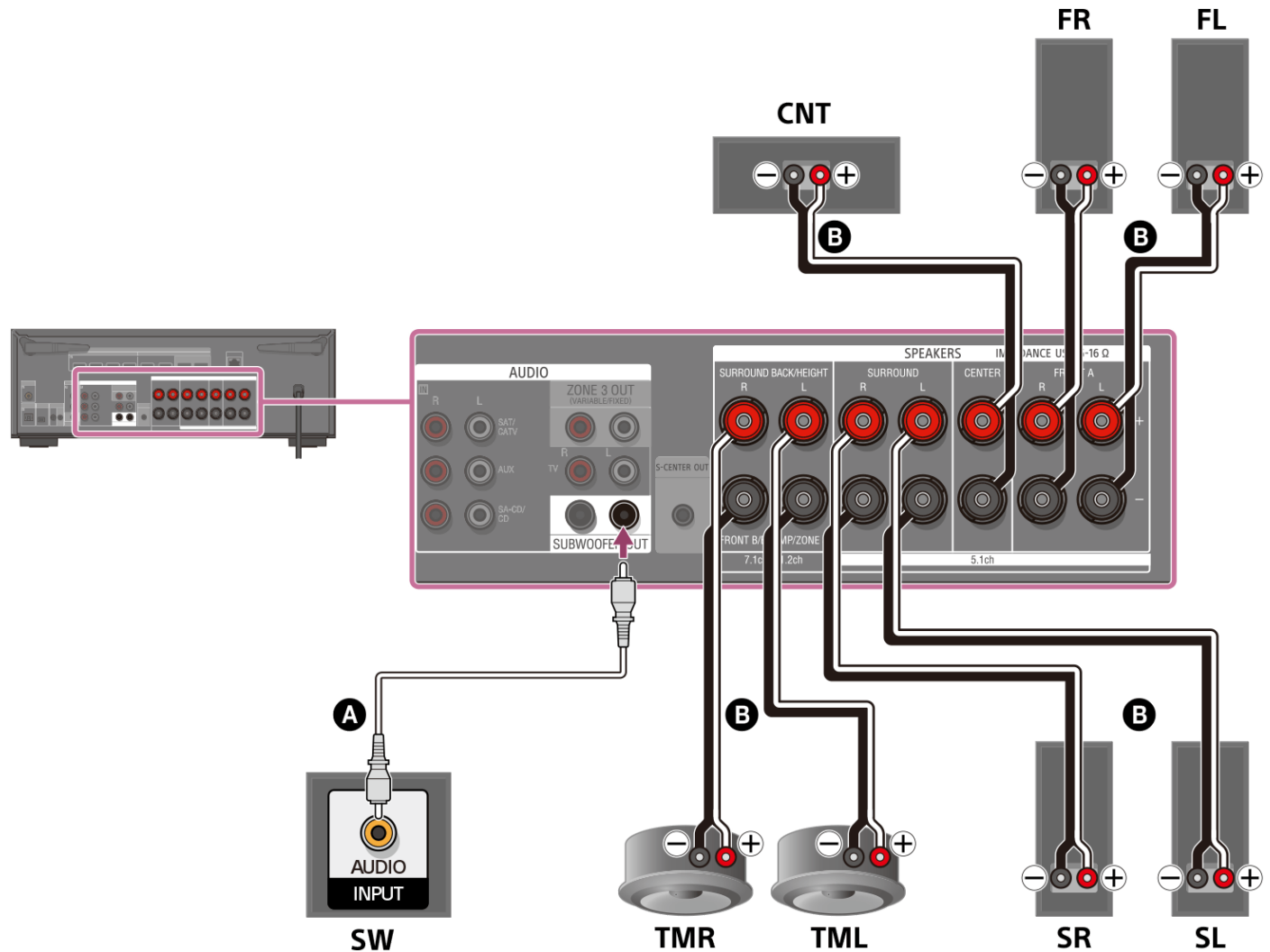

- A** Monaural audio cable (not supplied)
- B** Speaker cable (not supplied)

After connecting the top middle speakers, set [Speaker Pattern] in [Manual Speaker Settings] under [Speaker Settings] to [5.1.2 (TM)].

Note

- Connect speakers with a nominal impedance of 6 ohms to 16 ohms.

Related Topic

- [Speaker installation example](#)
- [Installing 5.1.2-channel speaker system using top middle speakers](#)
- [Selecting the speaker pattern \(Speaker Pattern\)](#)

- [Notes on connecting cables](#)
- [How to connect speaker cables](#)

5-037-030-11(5) Copyright 2022 Sony Corporation

Connecting 5.1.2-channel speaker system using front Dolby Atmos enabled speakers

Connect each speaker to the SPEAKERS terminals on the rear of the unit.
Before connecting cables, be sure to disconnect the AC power cord (mains lead).
For details on how to connect speaker cables to the unit, see [“How to connect speaker cables.”](#)

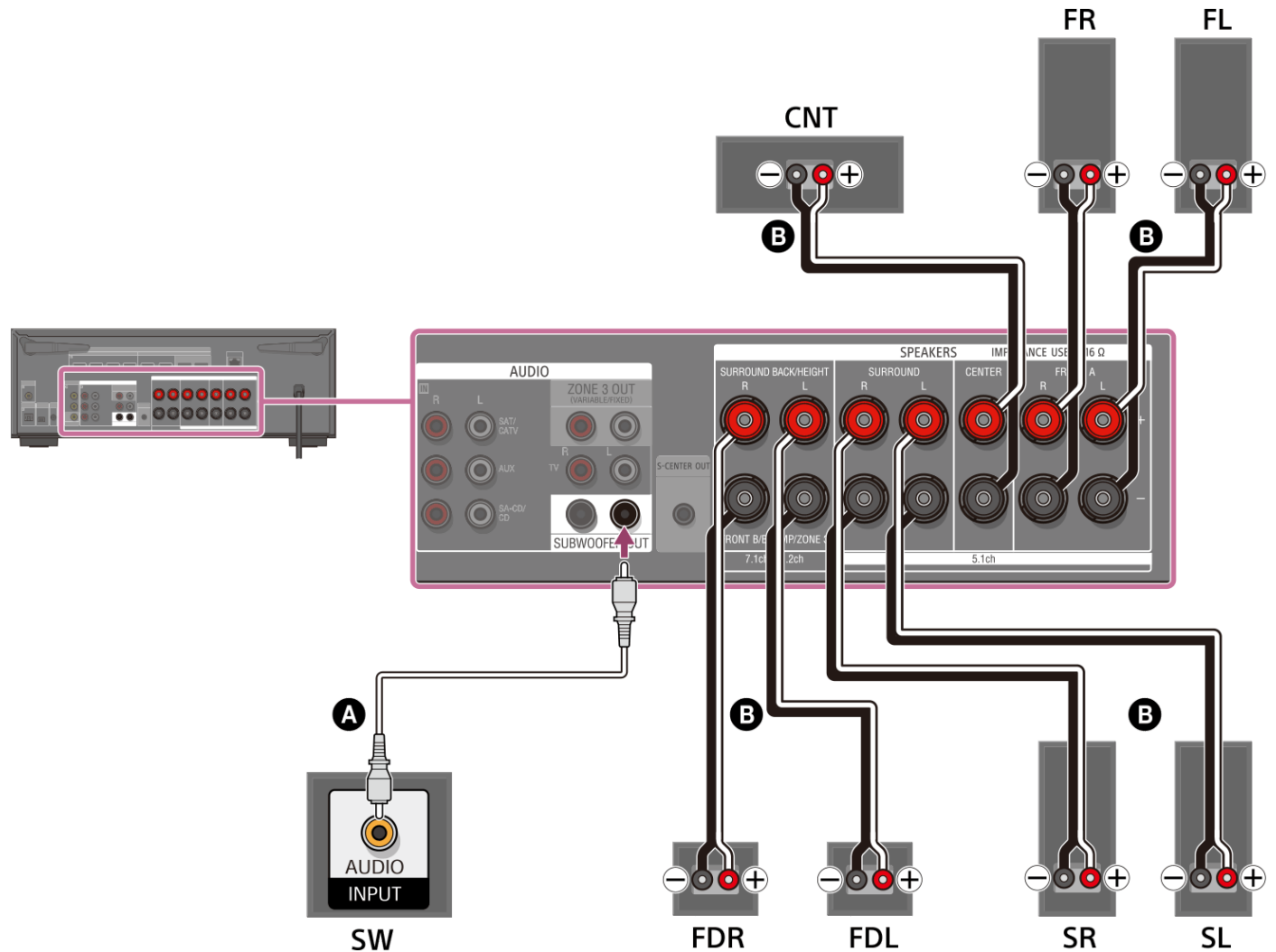

- A** Monaural audio cable (not supplied)
- B** Speaker cable (not supplied)

After connecting Dolby Atmos-enabled speakers, set [Speaker Pattern] in [Manual Speaker Settings] under [Speaker Settings] to [5.1.2 (FD)].

Note

- Connect speakers with a nominal impedance of 6 ohms to 16 ohms.

Related Topic

- [Speaker installation example](#)
- [Installing 5.1.2-channel speaker system using front Dolby Atmos enabled speakers](#)
- [Selecting the speaker pattern \(Speaker Pattern\)](#)

- [Notes on connecting cables](#)
- [How to connect speaker cables](#)

5-037-030-11(5) Copyright 2022 Sony Corporation

Connecting 5.1-channel speaker system with Zone 3 connection

Connect each speaker to the SPEAKERS terminals on the rear of the unit.
Before connecting cables, be sure to disconnect the AC power cord (mains lead).
For details on how to connect speaker cables to the unit, see [“How to connect speaker cables.”](#)

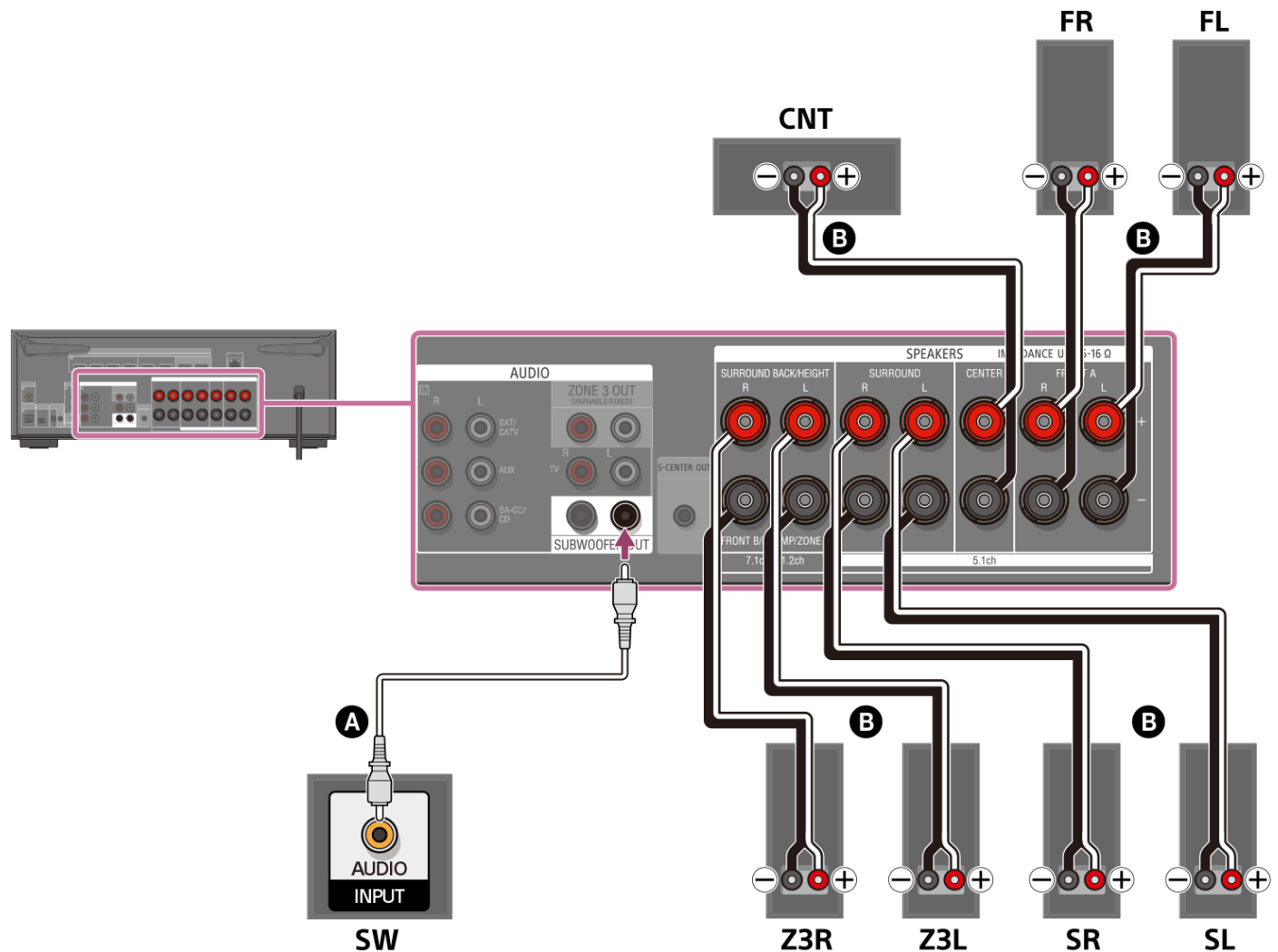

- A** Monaural audio cable (not supplied)
- B** Speaker cable (not supplied)

After you have made the Zone 3 connection, set [Surround Back Speaker Assign] in [Manual Speaker Settings] under [Speaker Settings] to [Zone3].

Note

- Connect speakers with a nominal impedance of 6 ohms to 16 ohms.
- After you have installed and connected your speakers, be sure to select the speaker pattern you want using [Speaker Pattern] in [Manual Speaker Settings] under [Speaker Settings].
- You can only set [Surround Back Speaker Assign] if the speaker pattern is set to a setting that does not have surround back and height/overhead speakers.
- To enjoy [USB], [Home Network], [Bluetooth Audio], [Chromecast built-in], [Spotify], or [AirPlay] in Zone 3, select [SOURCE] for the zone 3 input, then and switch the main zone input.

- When one of the external inputs (SAT/CATV, AUX, TV, or SA-CD/CD) is selected in Zone 3, the audio of the device connected to the AUDIO IN jack is played. To play the external digital input from the OPTICAL IN TV jack, the COAXIAL IN SA-CD/CD jack, or the HDMI IN jacks, select the target input for the main zone, and then select [SOURCE] for Zone 3.

Related Topic

- [Speaker installation example](#)
- [Installing 5.1-channel speaker system with Zone 3 connection](#)
- [Connecting 7.1-channel speaker system using surround back speakers](#)
- [Assigning the surround back speaker terminals \(Surround Back Speaker Assign\)](#)
- [Enjoying sound using speakers in Zone 3](#)
- [Notes on connecting cables](#)
- [How to connect speaker cables](#)

5-037-030-11(5) Copyright 2022 Sony Corporation

Connecting 5.1-channel speaker system with bi-amplifier connection

You can enhance the sound quality of the front speakers by separately connecting the built-in amplifiers to tweeters and woofers in a bi-amplifier configuration.

If you are not using surround back speakers or height/overhead speakers, you can connect the front speakers to the SPEAKERS SURROUND BACK/HEIGHT (FRONT B/BI-AMP/ZONE 3) terminals using a bi-amplifier connection.

Before connecting cables, be sure to disconnect the AC power cord (mains lead).

For details on how to connect speaker cables to the unit, see [“How to connect speaker cables.”](#)

Connecting front speakers with bi-amplifier connection

Connect the jacks on the Lo (or Hi) side of the front speakers to the SPEAKERS FRONT A terminals, and connect the jacks on the Hi (or Lo) side of the front speakers to the SPEAKERS SURROUND BACK/HEIGHT (FRONT B/BI-AMP/ZONE 3) terminals of the unit.

Make sure that metal fittings of Hi/Lo attached to the speakers have been removed from the speakers to avoid unit malfunction.

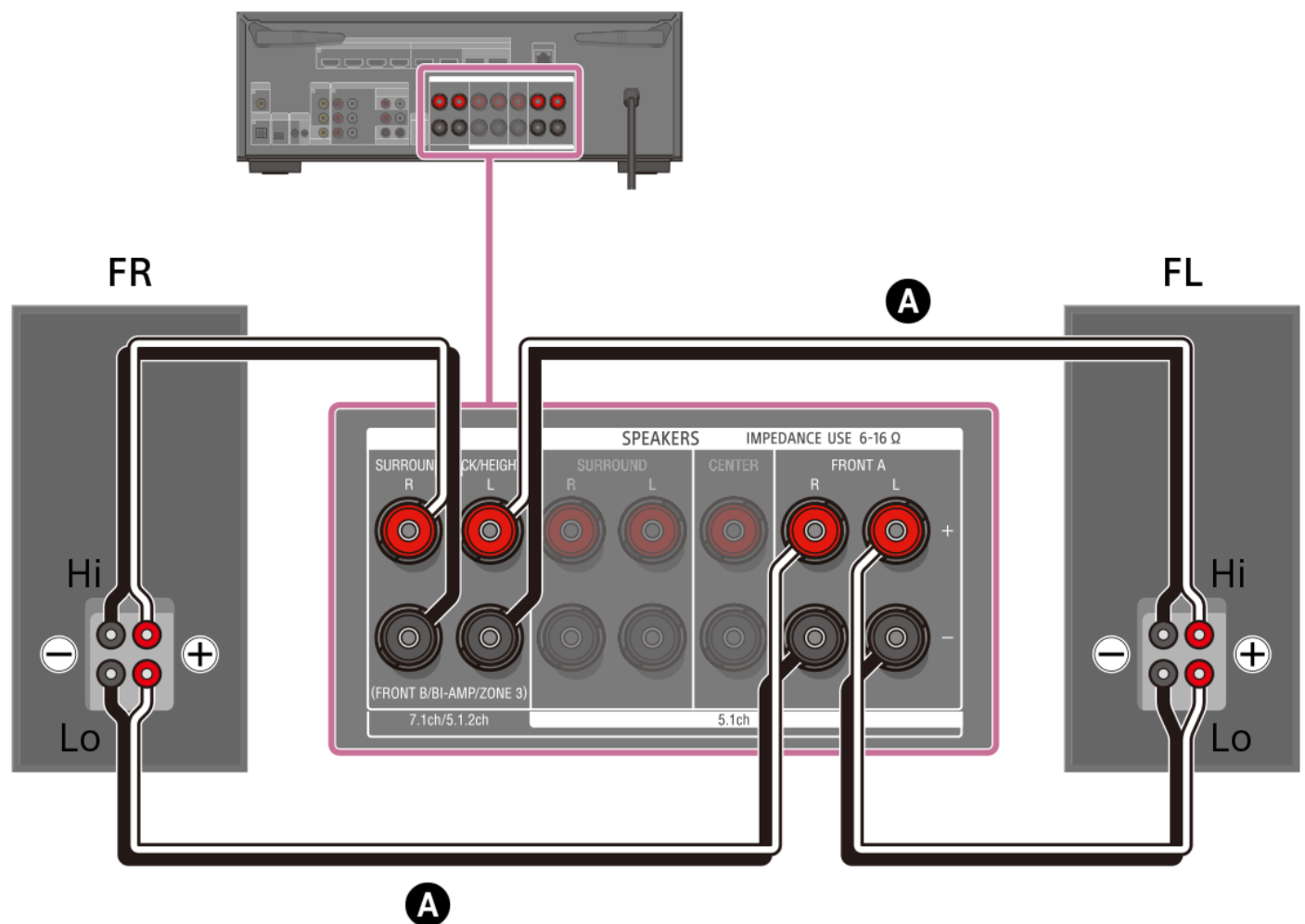

A Speaker cable (not supplied)

Connecting speakers other than front speakers

Connect both the surround L and surround R speakers to the SPEAKERS SURROUND terminals of the unit, connect the center speaker to the SPEAKERS CENTER terminals of the unit, and connect the subwoofer to the SUBWOOFER OUT terminal of the unit.

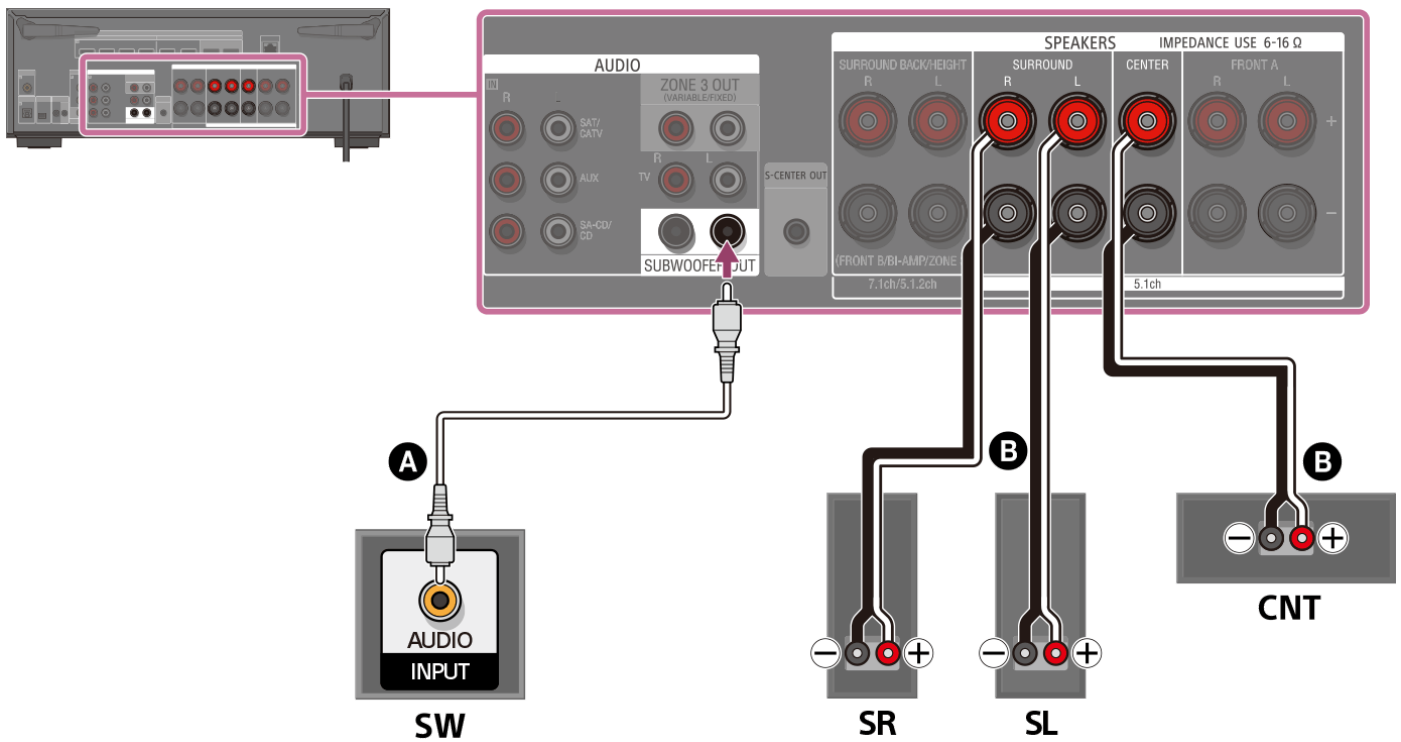

A Monaural audio cable (not supplied)

B Speaker cable (not supplied)

Make sure that metal fittings of Hi/Lo attached to the speakers have been removed from the speakers to avoid unit malfunction. After you have made the connection, set [Surround Back Speaker Assign] in [Manual Speaker Settings] under [Speaker Settings] to [BI-AMP].

Note

- Connect speakers with a nominal impedance of 6 ohms to 16 ohms.
- After you have installed and connected your speakers, be sure to select the speaker pattern you want using [Speaker Pattern] in [Manual Speaker Settings] under [Speaker Settings].
- You can only set [Surround Back Speaker Assign] if the speaker pattern is set to a setting that does not have surround back and height/overhead speakers.

Related Topic

- [Speaker installation example](#)
- [Installing 5.1-channel speaker system with bi-amplifier connection](#)
- [Selecting the speaker pattern \(Speaker Pattern\)](#)
- [Assigning the surround back speaker terminals \(Surround Back Speaker Assign\)](#)
- [Notes on connecting cables](#)
- [How to connect speaker cables](#)

Connecting 5.1-channel speaker system with front B speaker connection

Connect each speaker to the SPEAKERS terminals on the rear of the unit.

If you are not using surround back speakers or height/overhead speakers, you can connect additional front B speakers to the SPEAKERS SURROUND BACK/HEIGHT (FRONT B/BI-AMP/ZONE 3) terminals.

Before connecting cables, be sure to disconnect the AC power cord (mains lead).

For details on how to connect speaker cables to the unit, see [“How to connect speaker cables.”](#)

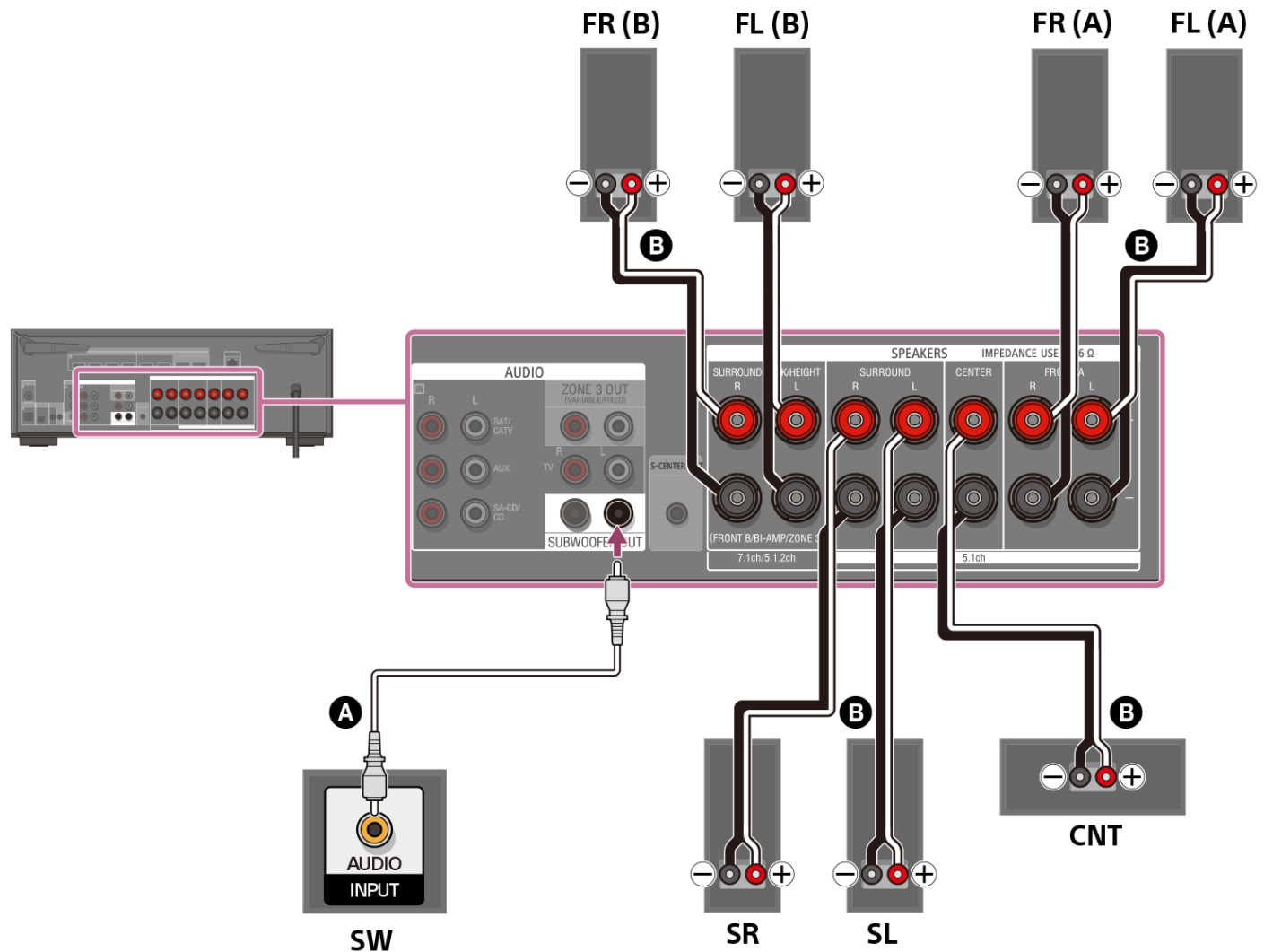

- A** Monaural audio cable (not supplied)
- B** Speaker cable (not supplied)

After you have made the front B speaker connection, set [Speaker Pattern] in [Manual Speaker Settings] under [Speaker Settings] to [Front B].

You can select the front speaker system you want to use by pressing SPEAKERS on the unit.

Note

- Connect speakers with a nominal impedance of 6 ohms to 16 ohms.
- After you have installed and connected your speakers, be sure to select the speaker pattern you want using [Speaker Pattern] in [Manual Speaker Settings] under [Speaker Settings].

- You can only set [Surround Back Speaker Assign] if the speaker pattern is set to a setting that does not have surround back and height/overhead speakers.

Related Topic

- [Selecting the front speakers](#)
- [Speaker installation example](#)
- [Installing 5.1-channel speaker system with front B speaker connection](#)
- [Selecting the speaker pattern \(Speaker Pattern\)](#)
- [Assigning the surround back speaker terminals \(Surround Back Speaker Assign\)](#)
- [Notes on connecting cables](#)
- [How to connect speaker cables](#)

5-037-030-11(5) Copyright 2022 Sony Corporation

Multi Channel AV Receiver/Multi Channel AV Amplifier
STR-AN1000/TA-AN1000

Connecting Sony wireless rear speakers/subwoofer

The unit is compatible with connection to Sony wireless rear speaker/subwoofer (not supplied).

When you connect the wireless rear speaker/subwoofer to the unit for the first time, follow the steps below. Once the Sony wireless rear speaker/subwoofer turns on, it will automatically connect to the unit.

1. Select [Setup] - [Speaker Settings] from the home menu.
2. Select [Wireless Speaker Settings].
3. Select [Start manual linking].
4. Press LINK on the speaker (not supplied).
The power indicator of the speaker flashes twice repeatedly in green.
5. Select [Start].
The manual connection starts. The connecting process appears on the TV screen. To cancel the manual connection, select [Cancel].
6. When [Connected] is displayed for the target speakers, select [Finish].
7. Press  (enter).
The manual connection is established and the power indicators of the speaker light up in green.
8. Follow the on-screen instructions to perform Auto Calibration.
When the connection settings of wireless speakers are complete, a screen that guides you to [Auto Calibration] is displayed.
When you connect a wireless rear speaker, select either [Surround] or [Surround Back] on the [- Wireless Speaker Assign] screen in [Auto Calibration] to assign the speaker position.

Hint

- For the latest information about the compatible wireless rear speaker/subwoofer models, visit the Sony website.
- If you connect 2 wireless subwoofers, use the same model.
- For details on the wireless rear speaker/subwoofer, refer to the operating instructions supplied with each speaker.

If the wireless communication is unstable

If you use multiple wireless devices, such as a wireless LAN router, the wireless signals may become unstable. In this case, the wireless communication may be improved by changing the following setting.

1. Select [Setup] - [Speaker Settings] from the home menu.
2. Select [Wireless Speaker Settings].
3. Select [RF Channel].
4. Select the setting you want.
 - [On]: Normally select this setting. The unit automatically selects the optimum frequency with wireless interference resistance for better wireless communication.
 - [Off]: The unit selects a channel from the limited frequency band to prevent external wireless interference. If sound dropping occurs while [On] is selected, it may be improved by selecting [Off].

Note

- If you change the [RF Channel] setting from [Off] to [On], it may take 1 minute to reconnect.

5-037-030-11(5) Copyright 2022 Sony Corporation

Multi Channel AV Receiver/Multi Channel AV Amplifier
STR-AN1000/TA-AN1000

Notes on TV connection

- Before connecting cables, be sure to disconnect the AC power cord (mains lead).
- Depending on the status of the connection between the TV and the antenna (aerial), the image on the TV screen may be distorted. If this is the case, place the antenna (aerial) farther away from the unit.
- When connecting an optical digital cable, insert the plugs straight until they click into place.
- Do not bend or tie optical digital cables.
- All of the digital audio jacks are compatible with 32 kHz, 44.1 kHz, 48 kHz, and 96 kHz sampling frequencies.
- When connecting TV audio output to the unit via the AUDIO IN TV (L/R) jacks, set the audio output level of the TV to "Fixed" if it can be switched between "Fixed" or "Variable."
- When you connect the TV to HDMI OUT B /ZONE 2 jack, be sure to set [HDMI OUT B Mode] to [Main] in the [HDMI Settings] menu. Press HDMI OUT repeatedly on the remote control to select [HDMI B] or [HDMI A+B]. The home menu is not displayed on the TV screen if [HDMI OUT B Mode] is set to [Zone2].
- When you connect a TV compatible with the eARC or ARC function, turn on the eARC or ARC function and connect the eARC/ARC-compatible HDMI input jack of your TV to HDMI OUT A (TV) jack of the unit.

Connecting a TV compatible with the eARC or ARC function using an HDMI jack

Connect a TV to the HDMI OUT A (TV) jack.

You can listen to TV sound from the speakers connected to the unit simply by connecting one HDMI cable. The HDMI cable outputs audio/video signals to the TV and inputs audio signals from the TV at the same time.

Be sure to disconnect the AC power cord (mains lead) before connecting cables.

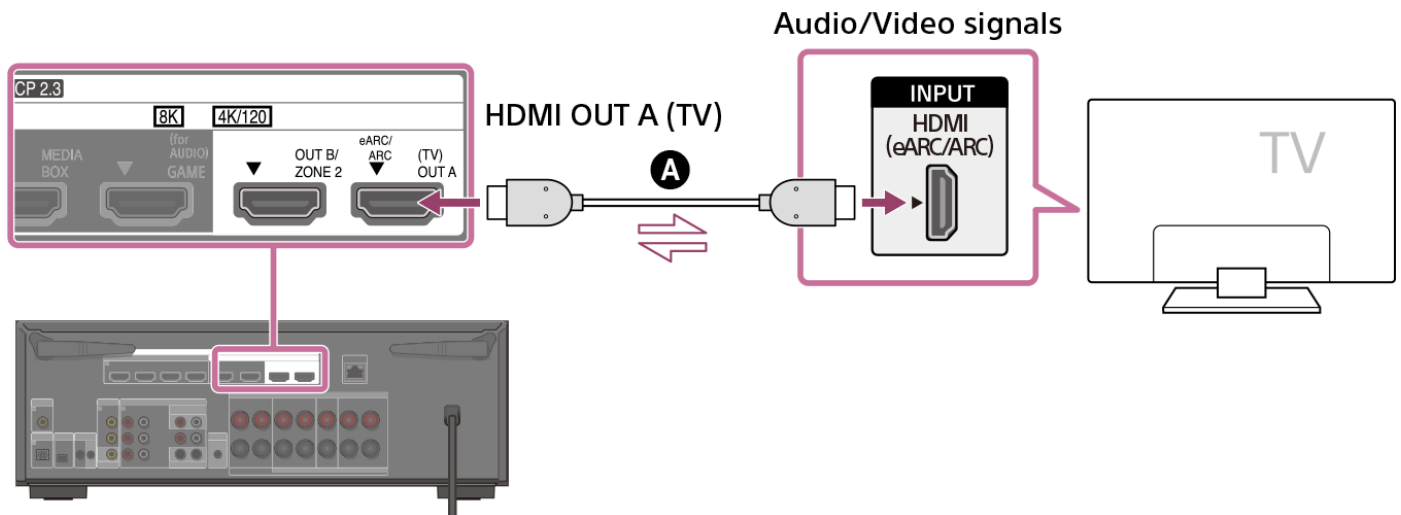

A HDMI cable (not supplied)

Note

- You must turn on the eARC or ARC function to use this connection. Select [Audio Return Channel] - [eARC] or [ARC] in the [HDMI Settings] menu.
- Be sure to use a Premium High Speed HDMI Cable with Ethernet, which supports bandwidths up to 18 Gbps. For video signals that require a high bandwidth such as 8K, 4K/120p, etc., be sure to use an Ultra High Speed HDMI Cable that supports bandwidths up to 48 Gbps.
- Select the HDMI signal format suitable for the video signal band of the TV or AV device connected with the HDMI cable from the menu of the unit.
- HDMI-DVI conversion cable is not recommended. If you connect an HDMI-DVI conversion cable to a DVI-D device, you may lose audio and/or image. If the audio is not output correctly, connect the audio cable or digital connection cable and set the input jack again.
- The TV side also needs to be set. Turn on the eARC or ARC function.

Hint

- You can operate this unit using the menu on the TV.
- If the HDMI jack of the TV (labeled "eARC" or "ARC") is already connected to another device, disconnect the device and connect the unit.

Related Topic

- [Notes on TV connection](#)
- [About input/output of video signals](#)
- [Notes on connecting cables](#)
- [About HDMI connections](#)

- Controlling HDMI devices (Control for HDMI)
- Enjoying content of a connected device without turning on the unit (Standby Through)
- Setting the HDMI audio signal output of connected devices (Audio Out)
- Setting HDMI signal formats (HDMI Signal Format)

5-037-030-11(5) Copyright 2022 Sony Corporation

Multi Channel AV Receiver/Multi Channel AV Amplifier
STR-AN1000/TA-AN1000

Connecting a TV incompatible with the eARC and ARC functions using an HDMI jack

Connect a TV to the HDMI OUT A (TV) jack.

When you connect the unit to a TV using the HDMI cable (**B**), the unit can output audio and video signals to the TV. Note, however, that you also need to connect the optical digital cable (**A**) or audio cable (**C**) to the TV in order to output TV audio from the speakers connected to the unit.

Be sure to disconnect the AC power cord (mains lead) before connecting cables.

Connecting with an HDMI cable and an optical digital cable

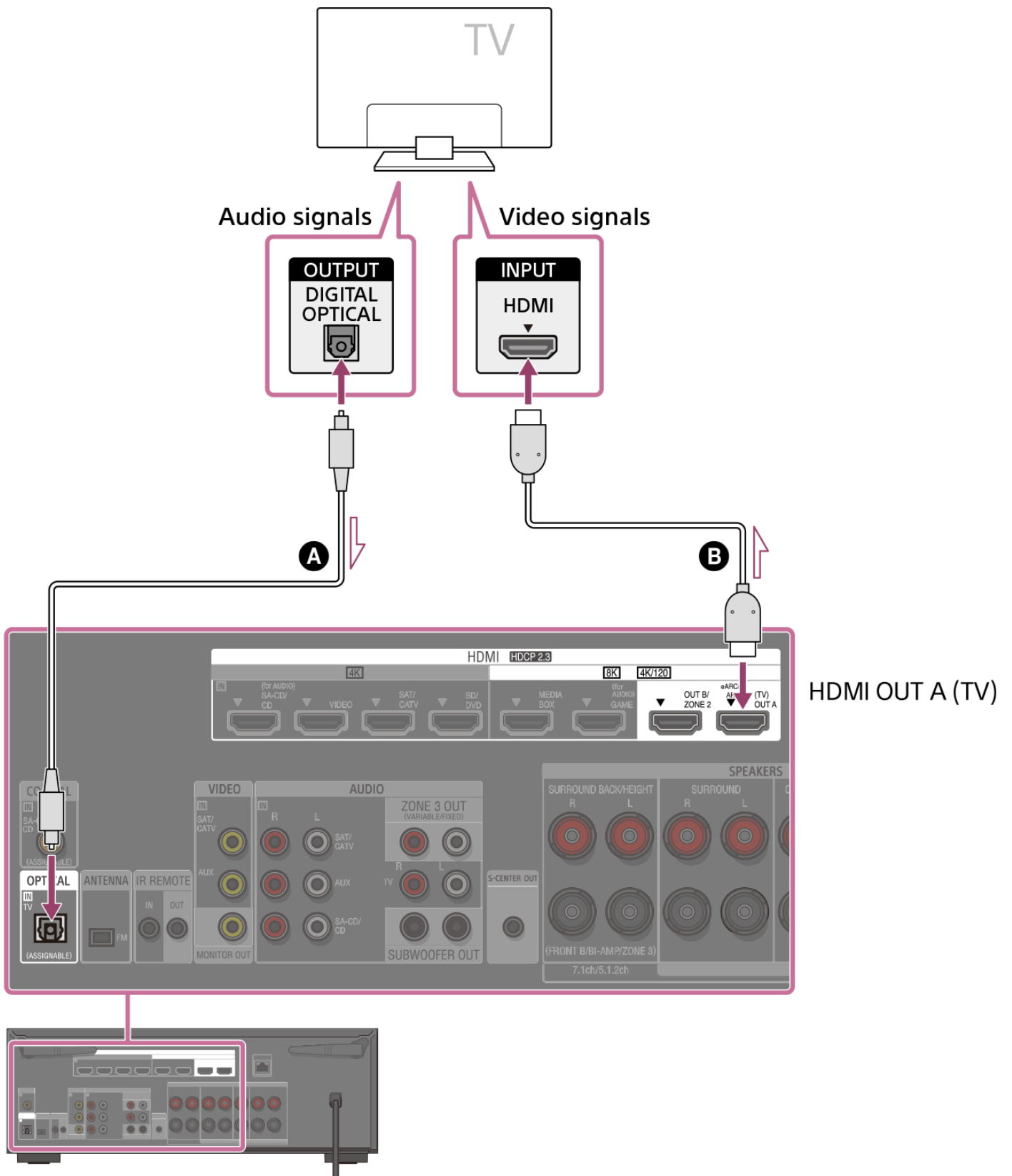

HDMI OUT A (TV)

Connecting with an HDMI cable and an audio cable

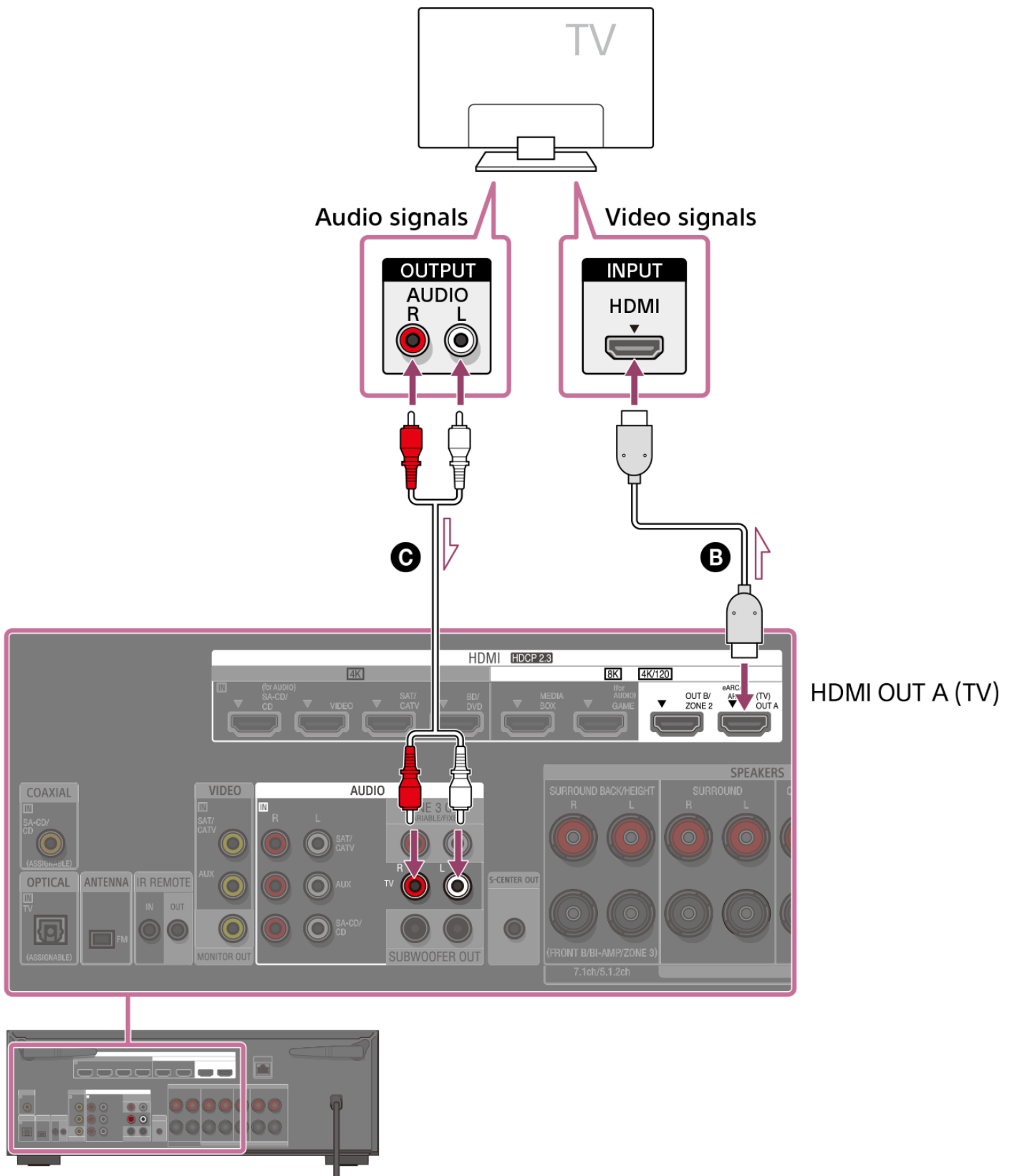

- Ⓐ Optical digital cable (not supplied)
- Ⓑ HDMI cable (not supplied)
- Ⓒ Audio cable (not supplied)

Note

- Be sure to use a Premium High Speed HDMI Cable with Ethernet, which supports bandwidths up to 18 Gbps. For video signals that require a high bandwidth such as 8K, 4K/120p, etc., be sure to use an Ultra High Speed HDMI Cable that supports bandwidths up to 48 Gbps.
- Select the HDMI signal format suitable for the video signal band of the TV or AV device connected with the HDMI cable from the menu of the unit.

- HDMI-DVI conversion cable is not recommended. If you connect an HDMI-DVI conversion cable to a DVI-D device, you may lose audio and/or image. If the audio is not output correctly, connect the audio cable or digital connection cable and set the input jack again.

Hint

- You can operate this unit using the menu on the TV.

Related Topic

- [Notes on TV connection](#)
- [About input/output of video signals](#)
- [Notes on connecting cables](#)
- [About HDMI connections](#)
- [Controlling HDMI devices \(Control for HDMI\)](#)
- [Enjoying content of a connected device without turning on the unit \(Standby Through\)](#)
- [Setting the HDMI audio signal output of connected devices \(Audio Out\)](#)
- [Setting HDMI signal formats \(HDMI Signal Format\)](#)

Multi Channel AV Receiver/Multi Channel AV Amplifier
STR-AN1000/TA-AN1000

Connecting a TV with jacks other than HDMI jacks

Connect a TV to the MONITOR OUT jack.

In addition to connecting with the video cable (A), it is necessary to connect with an optical digital cable (B) or audio cable (C).

Be sure to disconnect the AC power cord (mains lead) before connecting cables.

Connecting with a video cable and an optical digital cable

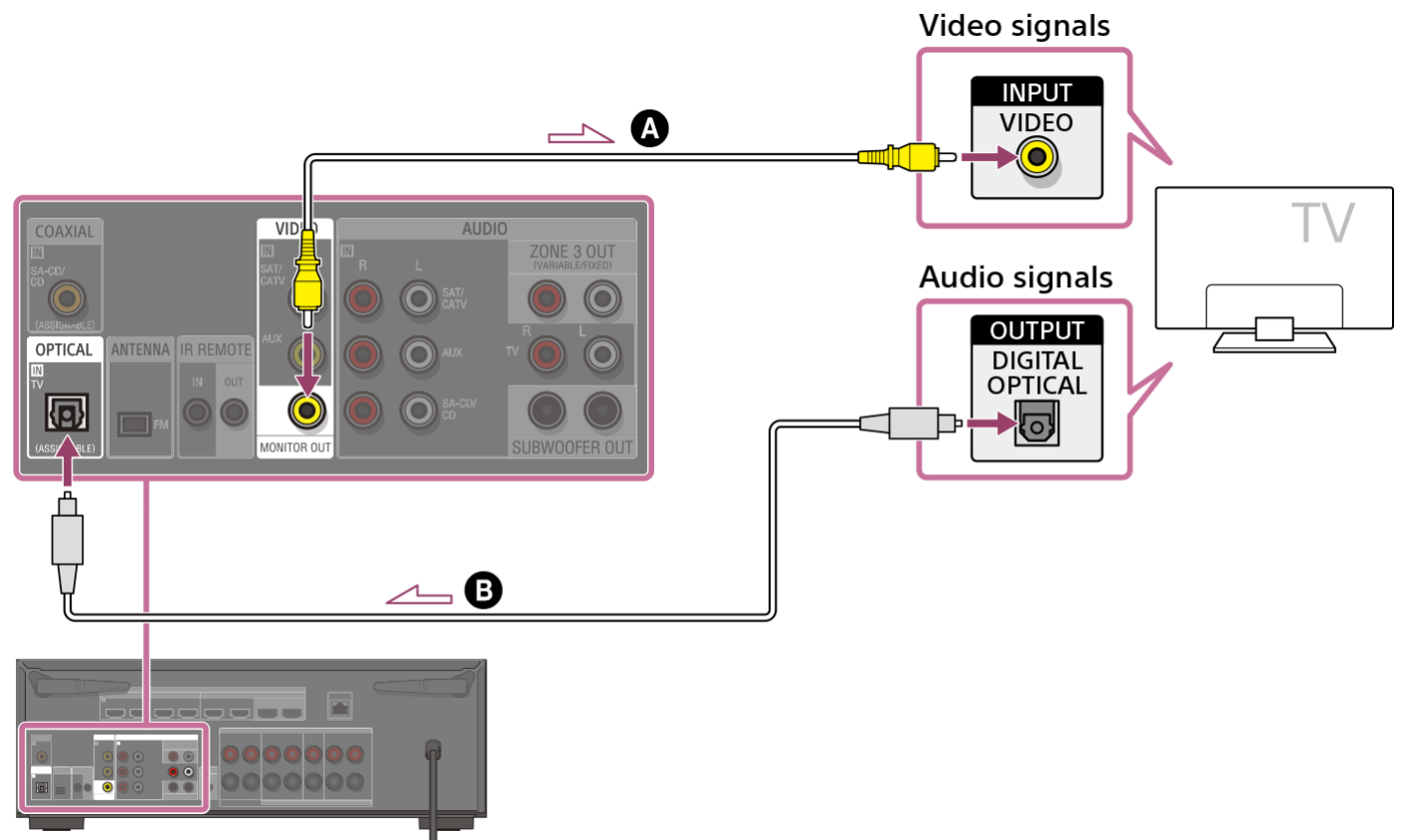

Connecting with a video cable and an audio cable

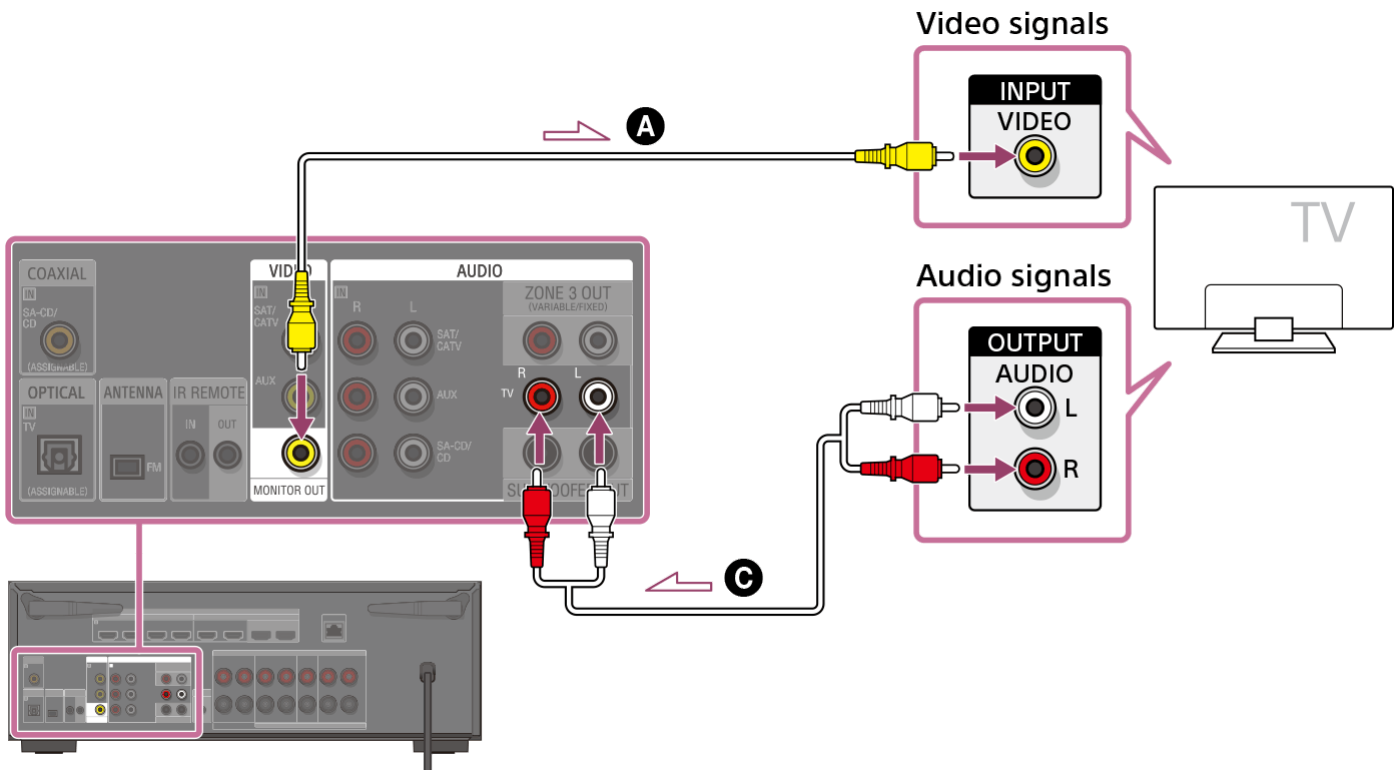

- A** Video cable (not supplied)
- B** Optical digital cable (not supplied)
- C** Audio cable (not supplied)

Note

- When the above connection is made, only the video from the device connected to the VIDEO IN jacks is displayed on the TV screen.
- When the above connection is made, the menu cannot be displayed. Connect with an HDMI cable to operate the unit using the menu.
- Depending on the status of the connection between the TV and the antenna (aerial), the image on the TV screen may be distorted. If this is the case, place the antenna (aerial) farther away from the unit.

Hint

- When connecting a TV to the unit via the AUDIO IN TV jacks of the unit, set the sound output jack of the TV to “Fixed” if it can be switched between “Fixed” or “Variable.”

Related Topic

- [Notes on TV connection](#)
- [About input/output of video signals](#)
- [Notes on connecting cables](#)

Connecting a TV and a projector using an HDMI jack

Connect a TV to the HDMI OUT A (TV) jack and connect a projector to the HDMI OUT B/ZONE 2 jack. Be sure to disconnect the AC power cord (mains lead) before connecting cables.

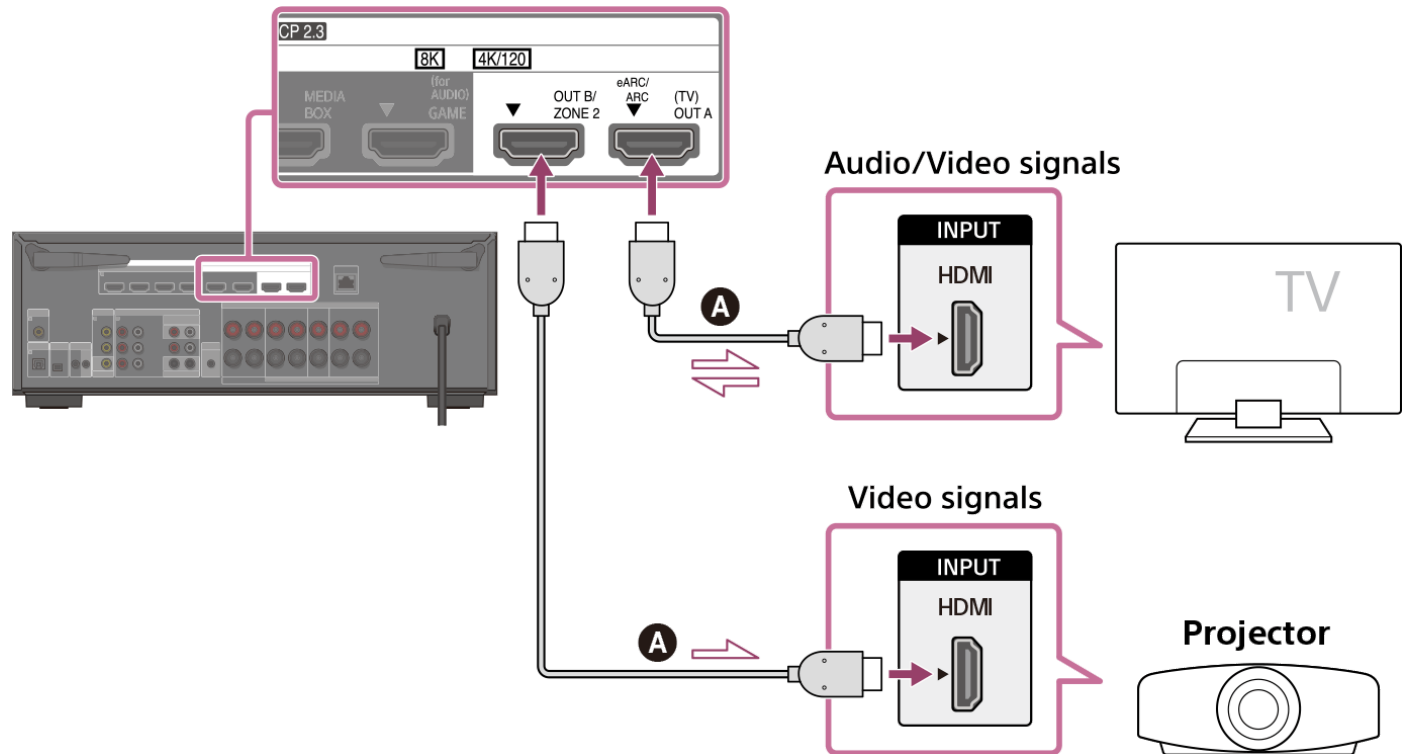

A HDMI cable (not supplied)

Note

- Be sure to use a Premium High Speed HDMI Cable with Ethernet, which supports bandwidths up to 18 Gbps. For video signals that require a high bandwidth such as 8K, 4K/120p, etc., be sure to use an Ultra High Speed HDMI Cable that supports bandwidths up to 48 Gbps.
- Select the HDMI signal format suitable for the video signal band of the TV or AV device connected with the HDMI cable from the menu of the unit.
- HDMI-DVI conversion cable is not recommended. If you connect an HDMI-DVI conversion cable to a DVI-D device, you may lose audio and/or image. If the audio is not output correctly, connect the audio cable or digital connection cable and set the input jack again.
- To display the same image as the TV, set [HDMI OUT B Mode] in the [HDMI Settings] menu to [Main], and then press HDMI OUT to select [HDMI A+B]. If you want to display different images on the TV and the projector, use the multi-zone function and set [HDMI OUT B Mode] to [Zone2].
- When [HDMI OUT B Mode] is set to [Zone2], the [Control for HDMI] and [Standby Linked to TV] functions do not work.

Hint

- You can operate this unit using the menu on the TV.

Related Topic

- [Notes on TV connection](#)

- [About input/output of video signals](#)
- [Notes on connecting cables](#)
- [About HDMI connections](#)
- [Setting TV audio output \(when using the eARC/ARC function\)](#)
- [Controlling HDMI devices \(Control for HDMI\)](#)
- [Enjoying content of a connected device without turning on the unit \(Standby Through\)](#)
- [Setting the HDMI audio signal output of connected devices \(Audio Out\)](#)
- [Selecting the method to use the HDMI OUT B jack \(HDMI OUT B Mode\)](#)
- [Setting HDMI signal formats \(HDMI Signal Format\)](#)

5-037-030-11(5) Copyright 2022 Sony Corporation

Multi Channel AV Receiver/Multi Channel AV Amplifier
STR-AN1000/TA-AN1000

Setting TV audio output (when using the eARC/ARC function)

ARC is a function that sends TV sound from the HDMI jack of the TV to an AV device such as the unit through an HDMI cable. eARC is an extension of this ARC, which enables the transmission of the object-based audio and multi-channel LPCM that cannot be transmitted by ARC.

If the HDMI OUT A (TV) jack of the unit is connected to a TV's HDMI input jack compatible with the eARC/ARC function, you can listen to TV sound from the speakers connected to the unit without connecting an optical digital cable or an audio cable. Set the unit by the following procedure to output the sound of the TV from the speakers connected to the unit.

1 Enable the eARC or ARC function of the TV.

- When using the ARC function: Turn on the Control for HDMI function of the TV. There is no problem even if you turn off the Control for HDMI function of devices other than the TV.
- When using the eARC function: Turn on the eARC function of the TV.

2 Select [Setup] - [HDMI Settings] from the home menu.

3 Select [Audio Return Channel].

4 Select [eARC] or [ARC] according to the functions your TV supports.

There is a difference in the audio format that can be played when the eARC function is activated and when the ARC function is activated. For the audio formats that can be played, see "[Digital audio formats supported by the unit.](#)"

- **eARC:** When you connect an eARC-compatible TV, the eARC function is activated. When you connect a TV that is compatible with ARC (but not compatible with eARC), the ARC function is activated.
- **ARC:** When you connect a TV compatible with eARC or ARC, the ARC function is activated. The eARC function is not available.
- **Off:** The eARC/ARC function is not available.

Note

- Be sure to minimize the volume of the TV or activate the muting function of the TV.
- You can operate steps 4 only when [Input Mode] for the TV input is set to [Auto].
- If your TV has a similar menu for eARC or ARC, also check the relevant settings on the TV. For details, refer to the operating instructions of the TV.

Hint

- If you want to play the signal via the optical digital audio cable or audio cable even if the TV is eARC-compatible or ARC-compatible, see "[Setting TV audio output \(when not using the eARC/ARC function\).](#)"

Multi Channel AV Receiver/Multi Channel AV Amplifier
STR-AN1000/TA-AN1000

Setting TV audio output (when not using the eARC/ARC function)

If your TV is connected to both the digital audio input jack and the analog audio input jack of this unit, you can lock or switch the audio input.

1 Select **[Setup]** - **[Input Settings]** from the home menu.

2 Select **[Assignment]**.

3 Set **[Input Mode]** according to how you connect the TV.

For details on the setting, see "[Switching between digital and analog audio \(Input Mode\)](#)."

Note

- Be sure to minimize the volume of the TV or activate the muting function of the TV.

When your TV has the S-CENTER SPEAKER IN jack

When the unit is connected to the S-CENTER SPEAKER IN jack of your TV, you can output the center part of the unit sound from the TV speakers. By using this connection, TV audio such as dialogue can be made to sound as if it is coming out of the TV screen. (Acoustic Center Sync function)

To use this function, you need to connect your TV to the HDMI OUT A (TV) jack of the unit. Also, set [TV Center Speaker Mode] to [Use TV as Center] in Auto Calibration.

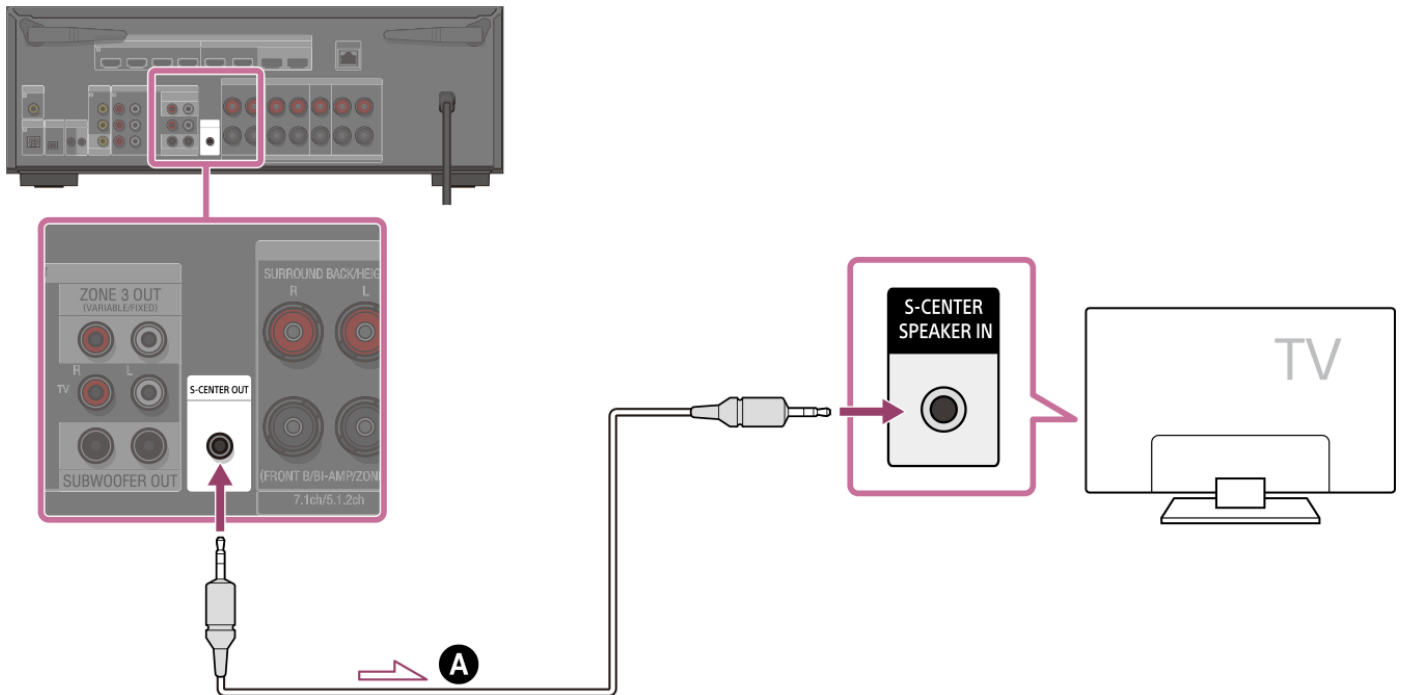

A Stereo 3-pole mini plug audio cable (not supplied)

Note

- When [Sound Field] is set to [2ch Stereo], the sound will not be output through the TV speaker.
- Depending on the sound source, the sound may not be output through the TV speaker.
- When headphones are connected and [Bluetooth Mode] is set to [Transmitter], the sound will not be output through the TV speaker.

Hint

- Some Sony TVs have an S-CENTER SPEAKER IN jack. For details, see the operating instructions of your TV.
- If you connect your TV to the S-CENTER OUT jack of the unit, press HOME, select [Setup] – [Speaker Settings] – [TV/Screen Center Settings] – [TV Center Speaker Mode] and then set to [Use TV as Center].

Connecting devices with HDMI jacks

Before connecting cables, be sure to disconnect the AC power cord (mains lead). Connect to the HDMI jack compatible with the video signal of your device.

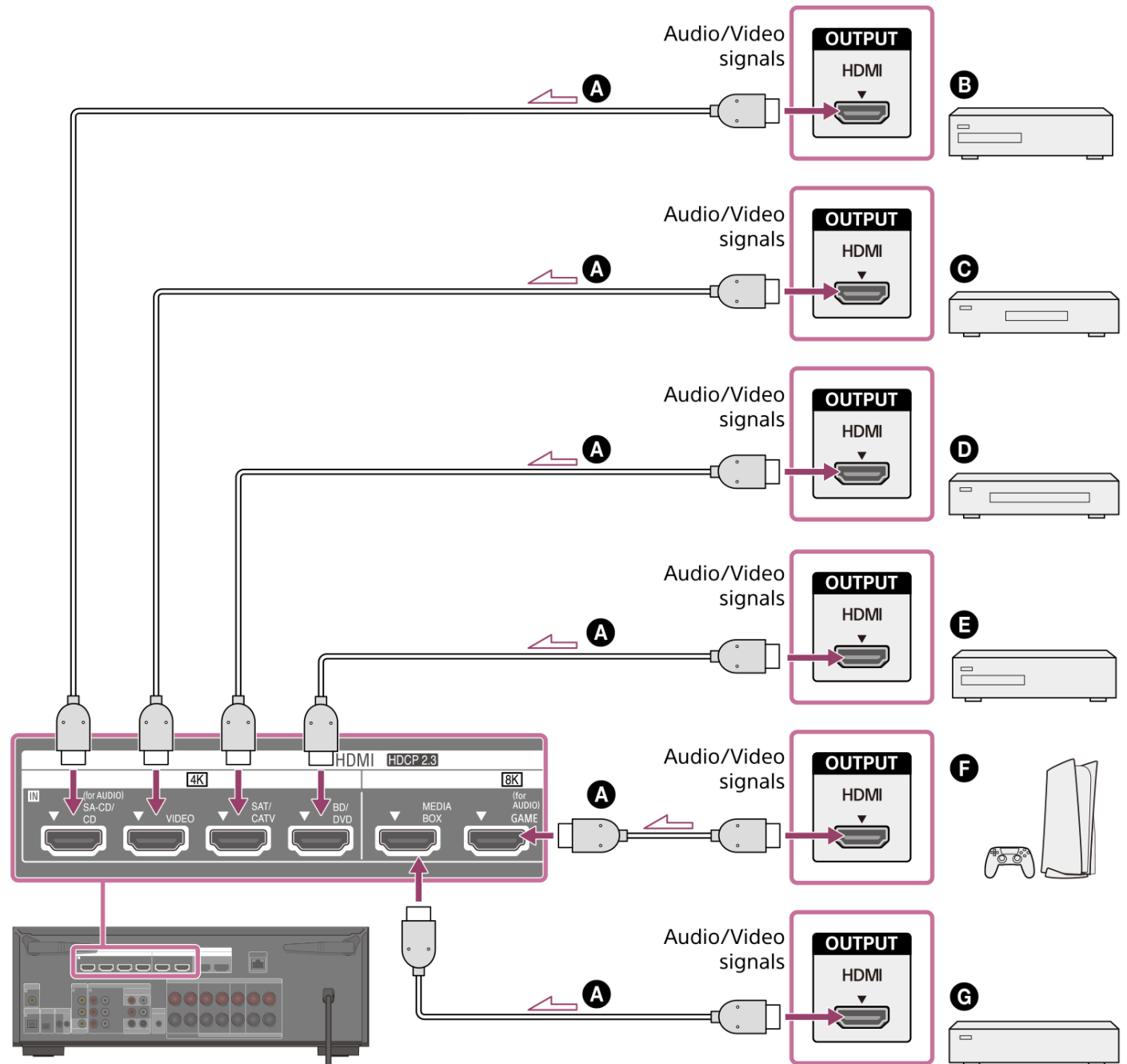

- A** HDMI cable (not supplied)
- B** Super Audio CD player, CD player
- C** Optional audio device
- D** Cable box or Satellite box
- E** Blu-ray Disc™ Player, DVD player
- F** Game console such as PlayStation 5
- G** Network media player

Video signals supported by HDMI jacks

| HDMI IN jack | Devices to be connected | |
|--------------------------|-------------------------|--|
| SA-CD/CD (for AUDIO) (*) | 4K | Connect a device that supports video signals up to 4K/60p. |
| VIDEO (*) | 4K | Connect a device that supports video signals up to 4K/60p. |
| SAT/CATV | 4K | Connect a device that supports video signals up to 4K/60p. |
| BD/DVD | 4K | Connect a device that supports video signals up to 4K/60p. |
| MEDIA BOX | 8K 4K/120 | Connect a device that supports video signals of 8K or up to 4K/120p. |
| GAME (for AUDIO) | 8K 4K/120 | Connect a device that supports video signals of 8K or up to 4K/120p. |

* When you connect your PC to this jack, supported video signals are limited to up to 4K/30p. Even in that case, you can enjoy 4K/60p video content by connecting your PC to SAT/CATV, BD/DVD, MEDIA BOX, or GAME (for AUDIO) jack.

Note

- The video signals that can be played in Zone 2 are limited. For the video signals that can be played in each zone, see "[Available input sources for each zone.](#)"

Hint

- The image quality depends on the type of connecting jack. We recommend you connect your devices via an HDMI connection if they have HDMI jacks.
- If you want to watch 8K or 4K/120p video from your device even when the eARC/ARC-compatible HDMI input jack of your TV is incompatible with 8K or 4K/120p video input, refer to "[When the eARC/ARC-compatible HDMI input jack of your TV is incompatible with 8K video input.](#)"

Related Topic

- [About input/output of video signals](#)
- [Notes on connecting cables](#)
- [About HDMI connections](#)
- [Changing the name for each input \(Name\)](#)
- [Connecting devices with jacks other than HDMI jacks](#)

Multi Channel AV Receiver/Multi Channel AV Amplifier
STR-AN1000/TA-AN1000

When the eARC/ARC-compatible HDMI input jack of your TV is incompatible with 8K video input

If the eARC/ARC compatible HDMI input jack of the TV does not support 8K video format, you cannot transmit the video of the original quality via the HDMI cable even if you connect an AV device that supports 8K video format to the unit. In that case, make a connection and a setting as follows.

- 1 Connect the unit to the eARC/ARC compatible HDMI input jack on the TV.
- 2 Connect the AV device to the HDMI input jack that supports 8K video format on the TV with an HDMI cable (not supplied).
- 3 Enable the eARC/ARC function on the TV.

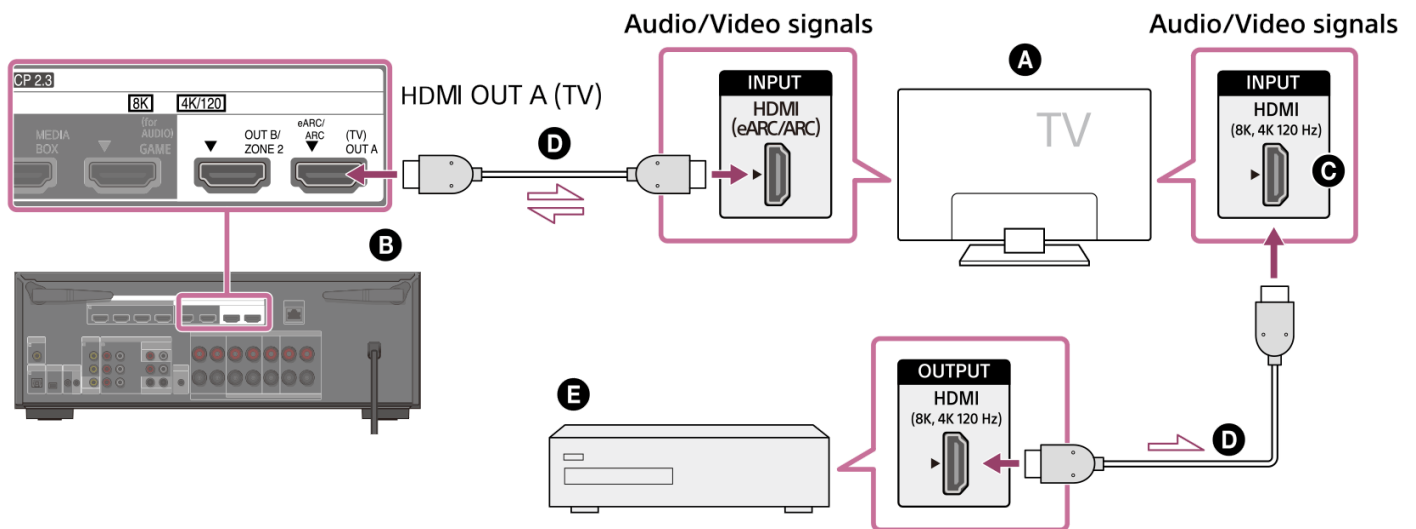

- A TV
- B The unit
- C HDMI input jack that supports 8K video input
- D HDMI cable (not supplied)
- E Audio device

Multi Channel AV Receiver/Multi Channel AV Amplifier
STR-AN1000/TA-AN1000

Connecting devices with jacks other than HDMI jacks

Connect each device to the video jack and audio jack on the rear panel of the unit.
Before connecting cables, be sure to disconnect the AC power cord (mains lead).

When connecting devices with video cables and a coaxial digital cable (recommended)

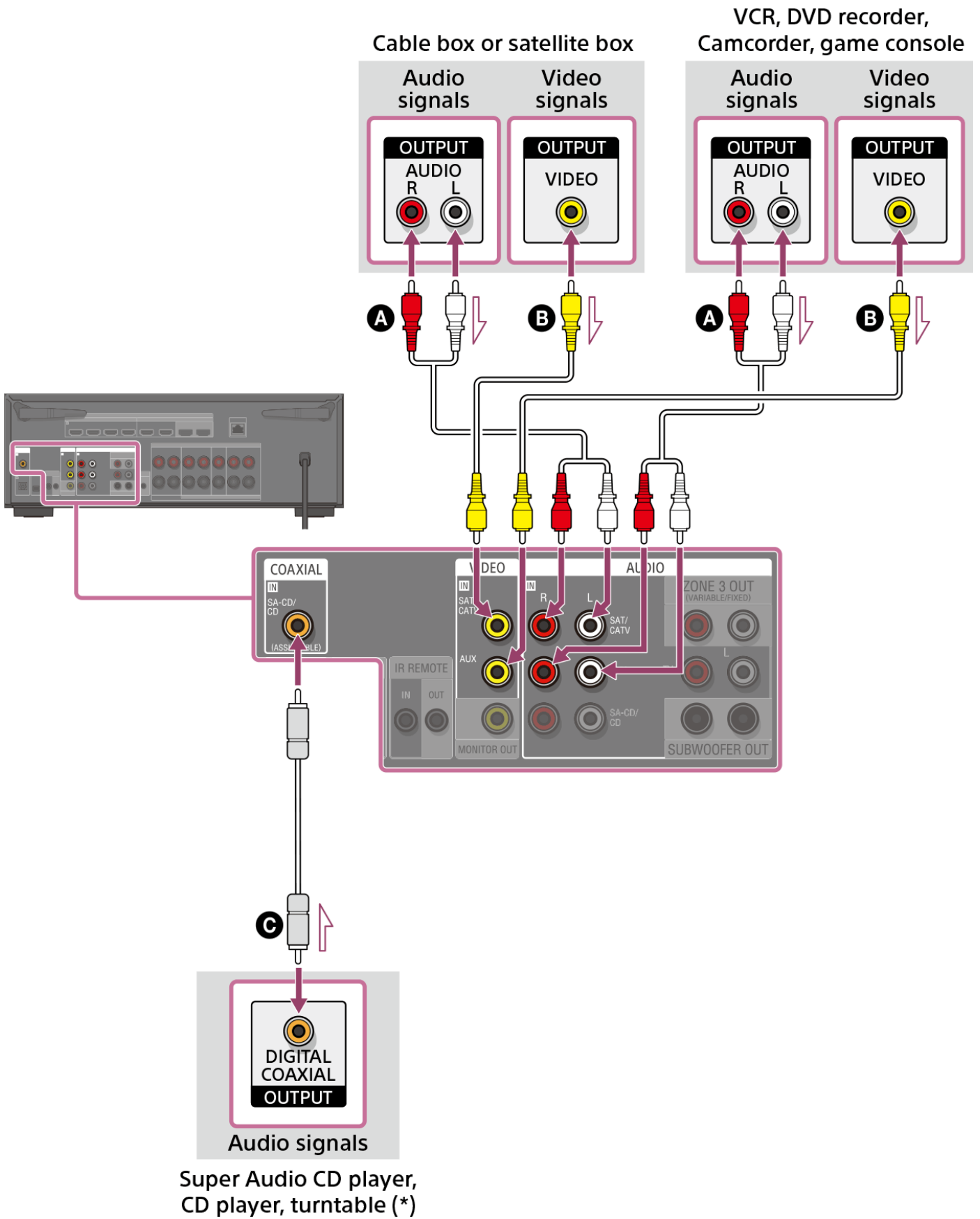

When connecting devices with video cables and audio cables

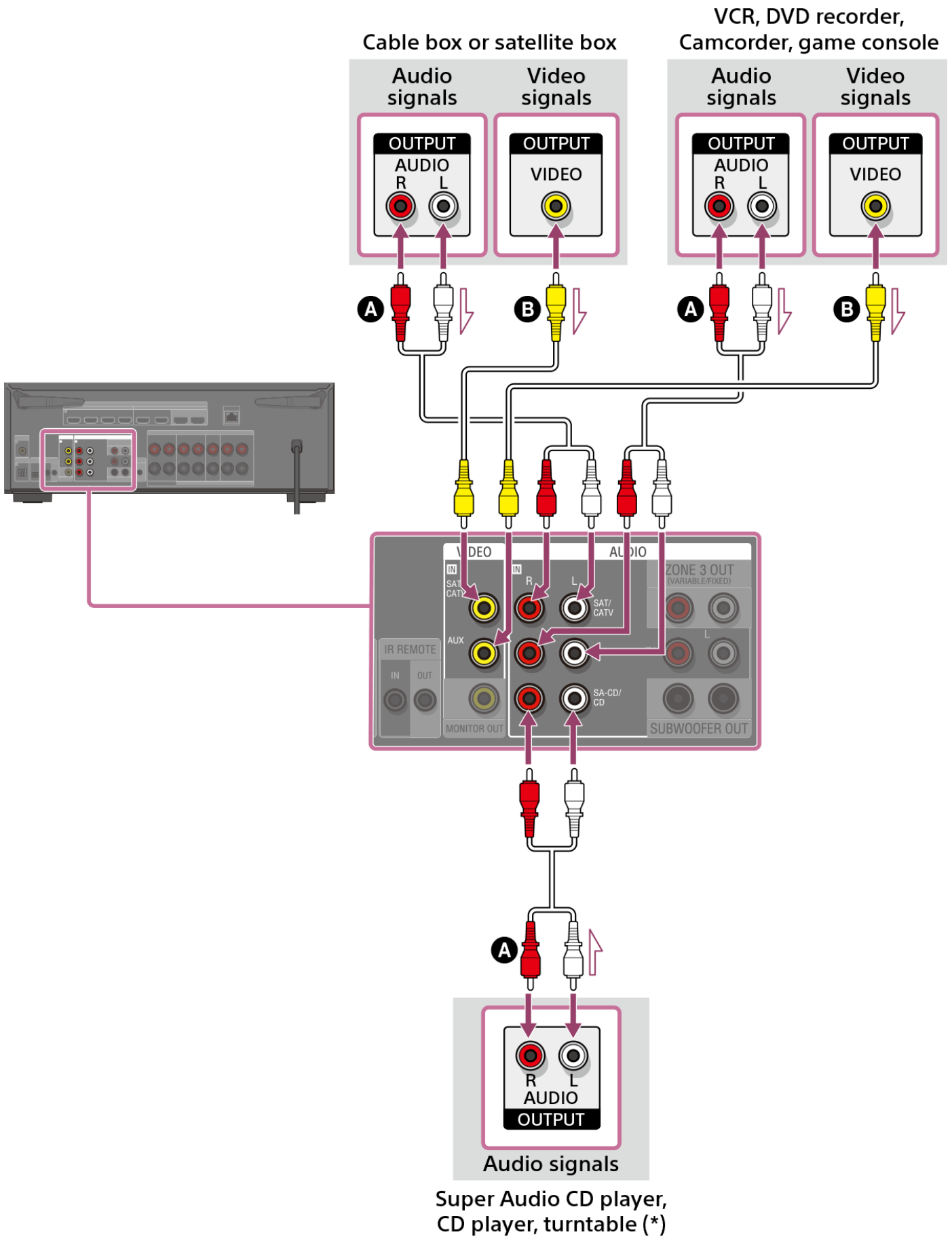

- A** Audio cable (not supplied)
- B** Video cable (not supplied)
- C** Coaxial digital cable (not supplied)

* To connect a turntable that only has a PHONO output jack, you need to connect a phono equalizer (not supplied) between the turntable and this unit.

Note

- The analog video signals input from the VIDEO IN jacks are output from the MONITOR OUT jack only.

- To listen to sound from a device connected to one of the AUDIO IN jacks, do not connect any device to the COAXIAL IN SA-CD/CD jack, the OPTICAL IN TV jack, or an HDMI IN jack labeled with the same device name (such as SAT/CATV, TV, or SA-CD/CD (for AUDIO)).

Hint

- You can connect devices other than those indicated above to the AUDIO IN jacks (SAT/CATV, AUX, and SA-CD/CD).
- You can rename each input so that the name can be displayed on the display panel of the unit. For details, see "[Changing the name for each input \(Name\)](#)."

Related Topic

- [About input/output of video signals](#)
- [Notes on connecting cables](#)
- [Using other digital audio input jacks \(Input Assign\)](#)
- [Changing the name for each input \(Name\)](#)

5-037-030-11(5) Copyright 2022 Sony Corporation

Multi Channel AV Receiver/Multi Channel AV Amplifier
STR-AN1000/TA-AN1000

Connecting a USB device

Connect a USB device to the  (USB) port.

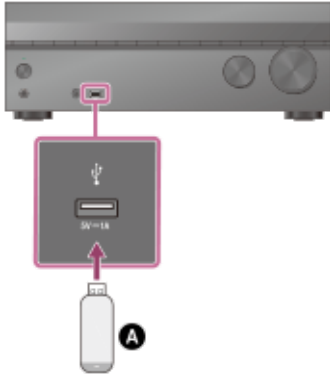

A USB device

Note

- iPhone/iPad/iPod touch playback via  (USB) port is not possible.

Related Topic

- [Enjoying music stored on a USB device](#)
- [USB specifications and compatible USB devices](#)
- [Notes on USB devices](#)

Multi Channel AV Receiver/Multi Channel AV Amplifier
STR-AN1000/TA-AN1000

Connecting the antenna (aerial) (for US, Canadian, and Asia-Pacific models only)

Connect the supplied FM wire antenna (aerial) to the FM ANTENNA terminal on the unit.
Before connecting antenna (aerial), be sure to disconnect the AC power cord (mains lead).

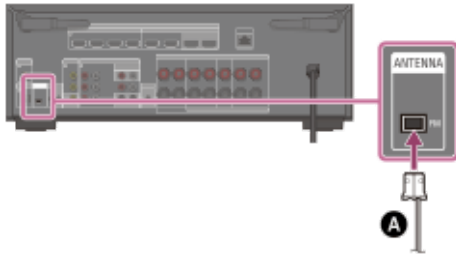

A FM wire antenna (aerial) (supplied)

Note

- Be sure to fully extend the FM wire antenna (aerial).
- After connecting the FM wire antenna (aerial), keep it as horizontal as possible.

Related Topic

- [Listening to FM radio \(for US, Canadian, and Asia-Pacific models only\)](#)

Connecting a LAN cable (for wired LAN connections only)

We recommend that you connect the server to the router with a wired connection. Connect the unit to the network using a LAN cable (*) (not supplied).

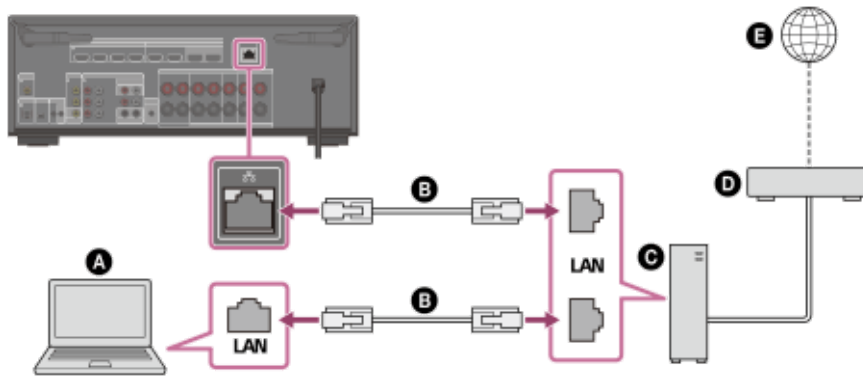

- A** Server (computer, etc.)
- B** LAN cable (*) (not supplied)
- C** Router
- D** Modem
- E** Internet

* We recommend using category 7 cables.

Hint

- Use a router compatible with transmission speeds of 100 Mbps or greater.
- We recommend that you use a router equipped with a built-in DHCP (Dynamic Host Configuration Protocol) server because the default setting on the unit is DHCP. This function automatically assigns IP addresses to devices on the LAN.
- We recommend using a normal shielded type cable for a wired LAN to avoid electric noise. Some flat-type LAN cables are easily affected by noise. We recommend using a Category 7 cable.

Related Topic

- [Notes on connecting cables](#)
- [Setting up a wired LAN connection](#)
- [Assigning a name to the unit \(Device Name Setting\)](#)

Multi Channel AV Receiver/Multi Channel AV Amplifier
STR-AN1000/TA-AN1000

Connecting the unit to the network using the wireless LAN antenna (for wireless LAN connections only)

When using a wireless connection, stand up both wireless LAN antennas for better performance.

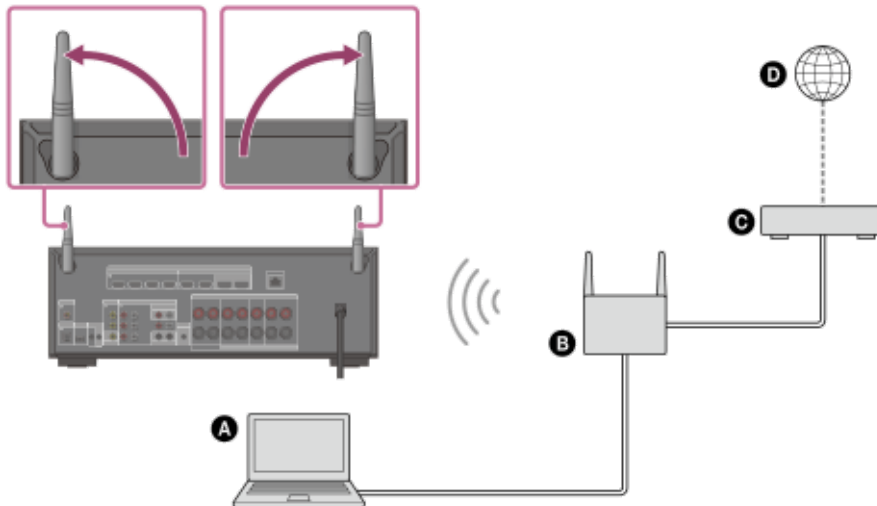

- A** Server (computer, etc.)
- B** Router
- C** Modem
- D** Internet

Note

- Audio playback on a server may occasionally be interrupted if you use a wireless connection.

Related Topic

- [Assigning a name to the unit \(Device Name Setting\)](#)

Multi Channel AV Receiver/Multi Channel AV Amplifier
STR-AN1000/TA-AN1000

Inserting batteries into the remote control

Slide and open the battery compartment cover, and then insert two R03 (size AAA) batteries (supplied) into the remote control. Make sure that the + and - ends are in the correct position when installing batteries.

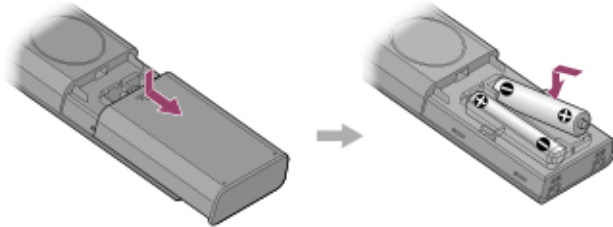

Note

- Do not leave the remote control in an extremely hot or humid place.
- Do not use a new battery with an old one.
- Do not mix manganese batteries with other kinds of batteries.
- Do not expose the remote control sensor to direct sunlight or lights. Doing so may cause a malfunction.
- If you do not intend to use the remote control for an extended period of time, remove the batteries to avoid possible damage from battery leakage and corrosion.
- When the unit no longer responds to the remote control, replace both of the batteries with new ones.

Multi Channel AV Receiver/Multi Channel AV Amplifier
STR-AN1000/TA-AN1000

Assembling the calibration mic stand

Assemble the calibration mic stand.

- 1 Insert the mic stand pillar all the way into the mic stand bottom.

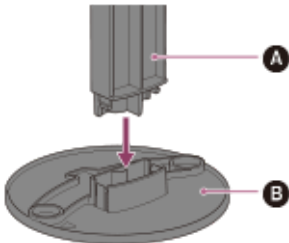

- A Mic stand pillar
- B Mic stand bottom

- 2 Insert the mic stand top all the way into the mic stand pillar.

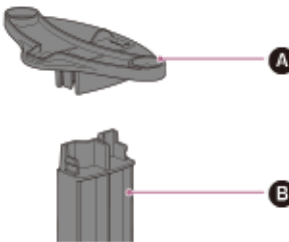

- A Mic stand top
- B Mic stand pillar

Multi Channel AV Receiver/Multi Channel AV Amplifier
STR-AN1000/TA-AN1000

Connecting the calibration microphone

Connect the supplied calibration microphone to the unit. In advance, assemble the mic stand.

1 Place the mic stand at your listening position and set the calibration microphone on the mic stand.

Adjust the position of the mic stand so that the calibration microphone is level with your ears.

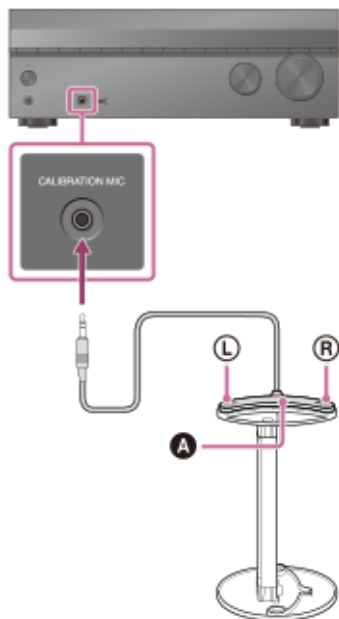

A Calibration microphone (supplied)

Note

- Fully insert the plug of the calibration microphone into the CALIBRATION MIC jack. If the calibration microphone is not firmly connected, it may not be possible to measure correctly.
- Install the calibration microphone horizontally so that L (left) and R (right) are at the same height.

Related Topic

- [Assembling the calibration mic stand](#)

Multi Channel AV Receiver/Multi Channel AV Amplifier
STR-AN1000/TA-AN1000

Turning on the unit

Before connecting the AC power cord (mains lead), be sure to make connections with speakers and the other devices.

Note

- Before connecting the AC power cord (mains lead), make sure that metallic wires of the speaker cables are not touching each other between the SPEAKERS terminals.

1 Connect the AC power cord (mains lead) to a wall outlet.

[HELLO] appears on the display panel and then switches to [PLEASEWAIT].

You cannot turn on the unit until the [PLEASEWAIT] display disappears.

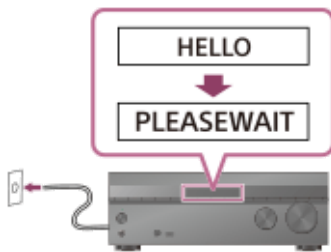

2 Press (power) to turn on the unit.

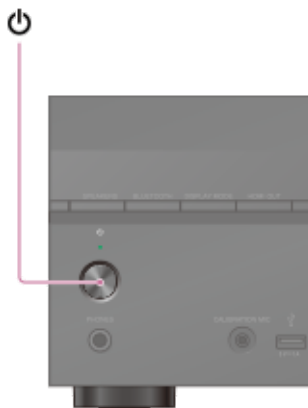

You can also turn on the unit using  (power) on the remote control.

Multi Channel AV Receiver/Multi Channel AV Amplifier
STR-AN1000/TA-AN1000

Setting up the unit using the [Easy Setup]

When you turn on the unit for the first time or after the unit is initialized, the Easy Setup screen appears on the TV screen.

Note

- It is not possible to perform the Easy Setup procedure using the indications on the front display panel.

1 Turn on the TV, and then switch the input of the TV to the unit.

2 Press  (power) to turn on the unit.



You can also turn on the unit using  (power) on the remote control.

3 Press  (up)/  (down) to select the language for the messages on the screen, and then press  (enter).

4 Follow the on-screen instructions to select items using  (up)/  (down)/  (left)/  (right) on the remote control, and confirm with  (enter).

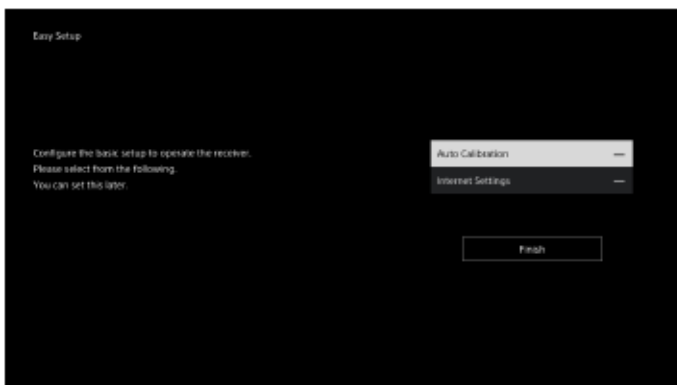

If the Easy Setup screen does not appear or you want to display the Easy Setup screen manually, you can display it by pressing HOME on the remote control, then select [Setup] - [Easy Setup].

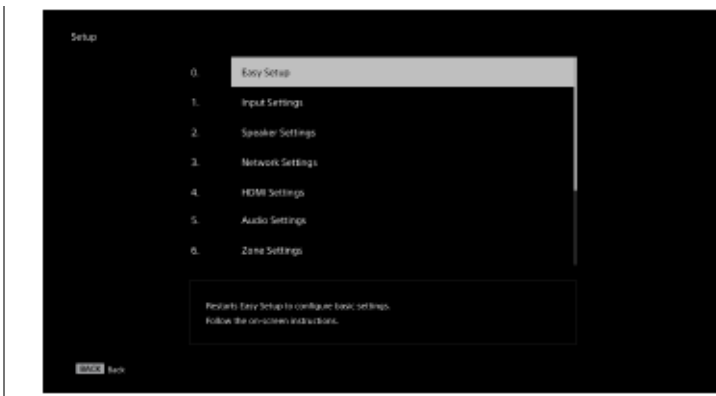

What you can do with Easy Setup

By performing Easy Setup, you can complete:

- **Language selection**
Set the language to be displayed on screen.
- **Auto Calibration**
Check your speaker system and perform Auto Calibration according to the configuration and arrangement of your speaker system.
- **Internet Settings**
Select the network connection method and configure settings to connect the unit to the network.

Related Topic

- [What you can do with Auto Calibration](#)
- [Before you perform Auto Calibration](#)
- [Connecting the calibration microphone](#)
- [Selecting the front speakers](#)
- [Auto Calibration operation](#)
- [Checking Auto Calibration results](#)
- [Setting up a wired LAN connection](#)
- [Setting up a wireless LAN connection](#)

Multi Channel AV Receiver/Multi Channel AV Amplifier
STR-AN1000/TA-AN1000

What you can do with Auto Calibration

Auto Calibration allows you to perform automatic calibration as follows.

- Check the connection between each speaker and the unit.
- Adjust the speaker level.
- Measure the distance of each speaker from your seating position. (*1)
- Measure the speaker size. (*1)
- Measure the frequency characteristics (EQ). (*1)
- Measure the frequency characteristics (Phase). (*1)(*2)

*1 The measurement result is not utilized when [Direct] is selected for the sound field setting and an analog input is selected.

*2 The measurement result may be not utilized, depending on the audio formats.

Note

- The D.C.A.C. IX (Digital Cinema Auto Calibration) is designed to achieve proper sound balance for your room. However, you can adjust the speaker levels manually according to your preference using [Test Tone] in [Manual Speaker Settings] under [Speaker Settings].

Related Topic

- [Outputting a test tone from each speaker \(Test Tone\)](#)

Multi Channel AV Receiver/Multi Channel AV Amplifier
STR-AN1000/TA-AN1000

Before you perform Auto Calibration

- Set up and connect the speakers.
- Disconnect the headphones.
- Remove any obstacles between the calibration microphone and the speakers.
- Do not connect any microphones other than the supplied calibration microphone to the CALIBRATION MIC jack.
- When [Bluetooth Mode] is set to [Transmitter], cancel the setting before performing Auto Calibration.
- For accurate measurement, make sure the environment is quiet and free from noise.
- Set the speaker output to a setting other than [SPK OFF]. See [“Selecting the front speakers.”](#)
- If using a bi-amplifier connection or speakers with a front B connection, set the assignment for the SPEAKERS SURROUND BACK/HEIGHT (FRONT B/BI-AMP/ZONE 3) terminals properly. For details, see [“Assigning the surround back speaker terminals \(Surround Back Speaker Assign\).”](#)

Note

- The speakers emit very loud sound during the calibration and the volume cannot be adjusted. Be considerate of your neighbors and any children who are present.
- If the muting function has been activated before you perform Auto Calibration, the muting function will shut off automatically.
- It may not be possible to take the correct measurements or to perform Auto Calibration at all if special speakers such as dipole speakers are used.

Confirming the subwoofer setup

- Before using a subwoofer, turn on the subwoofer and turn up the volume. Turn the LEVEL to just before the mid-point.



- When a subwoofer with a crossover frequency function is connected, set the value to maximum.



- When a subwoofer with an auto standby function is connected, set it to off (deactivated).

Note

- Depending on the characteristics of the subwoofer you are using, the setup distance value may be different from the actual position.

Related Topic

- [Connecting the calibration microphone](#)
- [Selecting the speaker pattern \(Speaker Pattern\)](#)
- [Assigning the surround back speaker terminals \(Surround Back Speaker Assign\)](#)

Multi Channel AV Receiver/Multi Channel AV Amplifier
STR-AN1000/TA-AN1000

Auto Calibration operation

Auto Calibration is performed twice.

- 1st calibration: Place the microphone on the mic stand top (①).
- 2nd calibration: Rotate the microphone 90 degrees and place it on the mic stand bottom (②).

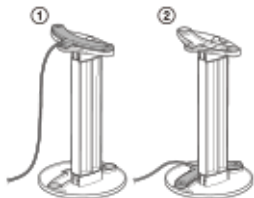

Note

- The speakers emit very loud sound during the calibration and the volume cannot be adjusted.
- If the muting function has been activated before you perform Auto Calibration, the muting function will shut off automatically.
- It may not be possible to take the correct measurements or to perform Auto Calibration at all if special speakers such as dipole speakers are used.
- If the measurement fails, follow the message, then select [Retry]. For details on the error code and warning message, see [“List of messages after Auto Calibration measurements.”](#)

To cancel Auto Calibration

The Auto Calibration function will be canceled when you perform the following operations, etc. during the measurement process:

- Press \odot (power).
- Press the input buttons on the remote control or turn the INPUT SELECTOR on the unit.
- Press HOME, AMP MENU, HDMI OUT or \times (muting) on the remote control.
- Press SPEAKERS on the unit.
- Change the volume level.
- Connect the headphones.

Related Topic

- [Connecting the calibration microphone](#)

Multi Channel AV Receiver/Multi Channel AV Amplifier
STR-AN1000/TA-AN1000

Selecting the front speakers

You can select the front speakers you want to operate.
Be sure to use the buttons on the unit to perform this operation.

- 1 Press **SPEAKERS** on the unit repeatedly to select the front speaker system you want to operate.

SPEAKERS



The indicators on the display panel shows which set of terminals are selected.

- **SPA:**
Speakers connected to the SPEAKERS FRONT A terminals.
- **SPB (*):**
Speakers connected to the SPEAKERS SURROUND BACK/HEIGHT (FRONT B/BI-AMP/ZONE 3) terminals.
- **SPA+B (*):**
Speakers connected to both the SPEAKERS FRONT A and SPEAKERS SURROUND BACK/HEIGHT (FRONT B/BI-AMP/ZONE 3) terminals (parallel connection).
- **(None):**
[SPK OFF] appears on the display panel. No audio signals are output from any speaker terminals.

* To select [SPB] or [SPA+B], set the assignment for the SPEAKERS SURROUND BACK/HEIGHT (FRONT B/BI-AMP/ZONE 3) terminals to [Front B] by using [Manual Speaker Settings] - [Surround Back Speaker Assign] in the [Speaker Settings] menu.

Note

- This setting is not available when headphones are connected.

Multi Channel AV Receiver/Multi Channel AV Amplifier
STR-AN1000/TA-AN1000

Checking Auto Calibration results

To check error codes or warning messages received in [Auto Calibration], proceed with the following steps:

If an error code appears

Check the error and perform Auto Calibration again.

- 1 **Select [Retry].**
- 2 **Follow the instructions on the TV screen to perform Auto Calibration.**

Auto Calibration is performed twice.
- 3 **When the measurement is completed, select the item you want.**
 - **Save:** Saves the measurement results and exits the setting process.
 - **Retry:** Performs the Auto Calibration again.
 - **Discard:** Exits the setting process without saving the measurement results.
- 4 **Save the measurement results.**

Select [Save] in step 3.
- 5 **If the [SpeakerRelocation / PhantomSurroundBack] function screen is displayed, select the desired setting by referring to “[Calibrating speaker positioning \(SpeakerRelocation / PhantomSurroundBack\)](#).”**

If [In-Ceiling Speaker Mode] is set to [Front & Center] or [Front], this screen will not be displayed, so proceed to step 6.
- 6 **Select the desired calibration type by referring to “[Selecting the Auto Calibration type \(Calibration Type\)](#).”**
- 7 **When the calibration matching function screen is displayed, select [Yes] or [No].**
 - **Yes:** By expanding the sweet spot of the listening position and adjusting the sound wave on the left and right of each speaker, you can enjoy more natural sound.
 - **No:** The measurement result of the Auto Calibration is applied as it is.
- 8 **Perform the 360 Spatial Sound Mapping demo as needed.**

If a warning message appears

Check the warning message and select [OK]. For details on the warning messages, see “[List of messages after Auto Calibration measurements.](#)”

Hint

- The measurement results may vary depending on the position of the subwoofer. However, continuing to use the unit with that value does not cause problems.

Related Topic

- [List of messages after Auto Calibration measurements](#)

5-037-030-11(5) Copyright 2022 Sony Corporation

Multi Channel AV Receiver/Multi Channel AV Amplifier
STR-AN1000/TA-AN1000

Content that can be played on the unit

This topic explains the operations you can use to enjoy movies and music with this unit. For example, you can use multiple devices with this unit as shown below.

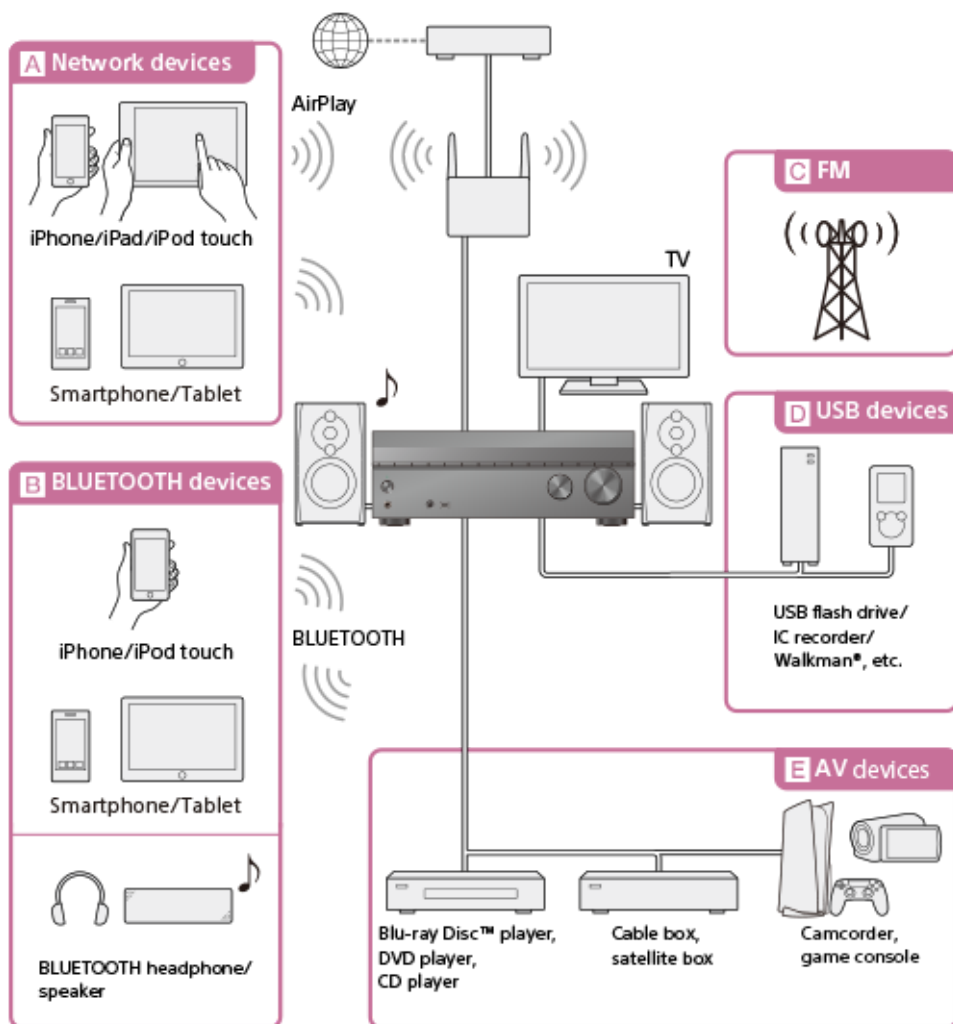

A Network devices

Enjoying audio content from an iPhone/iPad/iPod touch or other smartphone/tablet

You can send content such as audio from an iPhone/iPad/iPod touch or other smartphone/tablet to the unit via the network.

[What you can do with network features](#)

B BLUETOOTH devices

Enjoying audio content from an iPhone/iPod touch or other smartphone/tablet

You can transmit audio from an iPhone/iPod touch or other smartphone/tablet to the unit via BLUETOOTH.

[Enjoying audio content using the BLUETOOTH function \(Pairing operation\)](#)

Listening with BLUETOOTH receiver (headphones/speakers)

The BLUETOOTH TX function lets you enjoy listening to audio using BLUETOOTH headphones/speakers. This function does not need cables, so you can choose where you want to listen to music without worrying about cables.

[Listening with BLUETOOTH headphones/speakers \(Pairing operation\)](#)

C FM (for US, Canadian, and Asia-Pacific models only)

Listening to FM radio

You can listen to FM broadcasts in high-quality sound through the built-in tuner.

Preset function enables you to store up to 30 of your favorite FM stations as presets.

[Listening to FM radio \(for US, Canadian, and Asia-Pacific models only\)](#)

D **USB devices**

Enjoying content from a USB device

You can enjoy music from a USB device such as a USB flash drive or WALKMAN® by connecting it to the ψ (USB) port on the front panel of the unit and listening through speakers or headphones connected to the unit.

The unit is compatible with High Resolution Audio, which means you can enjoy high resolution audio from compatible devices without the loss of sound quality.

[Enjoying music stored on a USB device](#)

E **AV devices**

Enjoying movies or audio from an AV device such as a Blu-ray Disc player, CD player, satellite box or game console

You can connect AV devices to the unit to enjoy a wide range of content such as movies and audio.

As the unit is equipped with an HDCP 2.3-compatible HDMI jack, you can also enjoy 4K/8K content via streaming services, satellite broadcasts, etc.

[Playing AV devices](#)

Related Topic

- [What you can do with network features](#)

5-037-030-11(5) Copyright 2022 Sony Corporation

Multi Channel AV Receiver/Multi Channel AV Amplifier
STR-AN1000/TA-AN1000

How to use the menu of the unit

You can display the menu of the unit on the TV screen (*).

* When you want to display the menu on the TV screen connected to the HDMI OUT B/ZONE 2 jack, set [HDMI OUT B Mode] to [Main].

1 Switch the input of the TV to the input to which the unit is connected.

2 Press HOME to display the home menu on the TV screen.

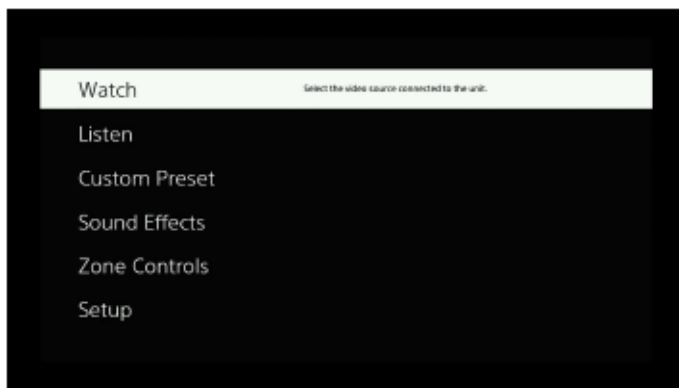

3 Press **▲** (up)/**▼** (down) repeatedly to select the menu you want, then press **⊕** (enter) to enter the menu.

Home menu items

Watch: Select to display video from the connected device.

Listen: Select to listen to sound from the built-in FM tuner (for US, Canadian, and Asia-Pacific models only) or the connected device.

Custom Preset: Select to save various settings for the unit and recall those settings.

Sound Effects: Select to enjoy sound effects.

Zone Controls: Select to use the multi-zone features.

Setup: Select to adjust the various settings for the unit.

Hint

- When [OPTIONS] appears in the lower left portion of the menu on the TV screen, you can display the function list by pressing OPTIONS and selecting a related function.
- To return to the previous screen, press BACK.
- To exit the menu, press HOME to display the home menu, then press HOME again.

Multi Channel AV Receiver/Multi Channel AV Amplifier
STR-AN1000/TA-AN1000

Viewing information on the display panel

The display panel provides various information on the status of the unit, such as the sound field.

1 Select the input for which you want to check information.

2 Press DISPLAY MODE on the unit repeatedly.

Each time you press DISPLAY MODE, the display will change cyclically as follows:

Index name of the input (*1) - Input you selected - Sound field currently applied (*2) - Volume level - Stream information (*3)

When listening to FM radio (For US, Canadian, and Asia-Pacific models only)

Preset station name (*1) - Frequency - Sound field currently applied (*2) - Volume level - Stream information (*3)

When receiving BLUETOOTH audio

Name of the connected device - Sound field currently applied (*2) - Volume level - Stream information (*3)

*1 Index name appears only when you have assigned one to the input or preset station. Index name does not appear if only blank spaces have been entered or it is same as the input name.

*2 [PURE.DIRECT] appears on the display panel when the [Pure Direct] function is activated.

*3 Stream information may not be displayed.

Checking the information of a connected BLUETOOTH device

You can check the BLUETOOTH device information by pressing DISPLAY MODE on the unit repeatedly. Each time you press DISPLAY MODE, the display will change cyclically as follows:

- During BLUETOOTH RX mode: Input you are selecting - BLUETOOTH device name - Sound field currently applied - Volume level - Stream information
- During BLUETOOTH TX mode: BLUETOOTH device name - Sound field currently applied - Volume level - Stream information - Input you are selecting

Note

- Characters or marks in some languages may not be displayed.

Related Topic

- [Indicators on the display panel](#)

Multi Channel AV Receiver/Multi Channel AV Amplifier
STR-AN1000/TA-AN1000

Playing AV devices

You can connect AV devices to the unit to enjoy a wide range of content such as movies and audio.

- 1 Turn on the device you want to play.
- 2 Turn the TV on, and then switch the input of the TV to the HDMI input to which the unit is connected.
- 3 Turn on the unit.

- 4 Press HOME.

The home menu is displayed on the TV screen.

Depending on the TV, the home menu may take some time to appear on the TV screen.

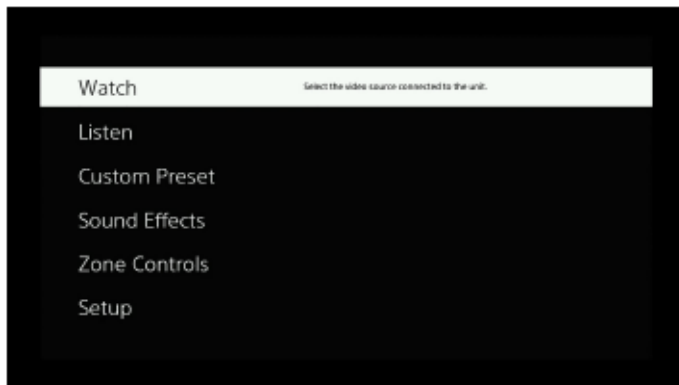

- 5 Select [Watch] or [Listen] from the home menu.
The menu item list appears on the TV screen.
- 6 Select the device you want to play and start playback.

- 7 Press \triangleleft (volume) +/- to adjust the volume.

You can also use MASTER VOLUME on the unit.



- 8 Press 2CH/MULTI, MOVIE or MUSIC to enjoy the surround sound.

You can also use 2CH/MULTI, MOVIE or MUSIC on the unit.

Note

- Before you turn off the unit, be sure to turn down the volume level. Otherwise, the next time you turn on the unit, sound may be output at a high volume level and damage your speakers.

Hint

- You can select the device you want by turning INPUT SELECTOR on the unit or pressing the input buttons on the remote control.
- To turn the volume up or down quickly, perform the following:
 - Turn the MASTER VOLUME knob on the unit quickly.
 - Press and hold one of the  (volume) +/- buttons.
- To adjust the volume, perform the following:
 - Turn the MASTER VOLUME knob on the unit slowly.
 - Press one of the  (volume) +/- buttons and release it immediately.

5-037-030-11(5) Copyright 2022 Sony Corporation

Multi Channel AV Receiver/Multi Channel AV Amplifier
STR-AN1000/TA-AN1000

Enjoying music stored on a USB device

You can enjoy music from a USB device by connecting it to the  (USB) port on the unit.







1 Select [Listen] - [USB] from the home menu.

The same operation can also be performed by pressing OTHERS on the remote control several times.

2 Select the track you want from the file list.

The selected track starts playing and the information of track appears on the TV screen.



Performing playback operations

Press  (left)/ (right) to select  /  (play/pause) or  /  (previous/next), and then press  (enter).

Operating the USB device using the remote control





You can operate the USB device using the remote control of the unit.

Press OTHERS several times to select [USB], and then use the following buttons:

-  : Starts or pauses playback.
-  : Moves to the start of the previous or next track.





Setting the playback mode

● Repeat Setting

After step 2, press  (left)/ (right) to select  (repeat) and press  (enter). Each time you press  (enter), the setting changes.

-  (all): Plays back all files on the USB device repeatedly.
-  (folder): Plays back all files in the selected folder repeatedly.
-  (track): Plays back only the selected file repeatedly.
-  (off): Plays back all files in the selected folder and stops playback with the last file.

● Shuffle Setting

After step 2, press  (left)/ (right) to select  (shuffle) and press  (enter). Each time you press  (enter), shuffle playback is switched on/off. The files targeted for shuffle playback are based on the setting for Repeat Setting.

Note

- The unit can recognize the following files or folders in USB devices:
 - up to folders in the 11th layer (including the root folder)
 - up to 998 files/folders in a single layer
- Audio content with DRM (Digital Rights Management) copyright protection cannot be played on this unit.

Related Topic

- [Connecting a USB device](#)
- [USB specifications and compatible USB devices](#)

Multi Channel AV Receiver/Multi Channel AV Amplifier
STR-AN1000/TA-AN1000

USB specifications and compatible USB devices

Playable types of audio files (*1)

MP3 (MPEG-1 Audio Layer III):

.mp3

MPEG-H:

.mp4

AAC/HE-AAC:

.m4a, .aac, .mp4, .3gp

WMA9 Standard:

.wma

LPCM:

.wav

FLAC:

.flac

DSF:

.dsf

DSDIFF (*2):

.dff

AIFF:

.aiff, .aif

ALAC:

.m4a

Vorbis:

.ogg

Monkey's Audio:

.ape

*1 Compatibility with all encoding/writing software, recording devices and recording media cannot be guaranteed.

*2 The unit does not play DST encoded files.

Note

- Some files may not play depending on the file format or the file encoding.
- Some files that have been edited on a computer may not play.
- Fast forward or fast reverse functions may not be available for some files.
- The unit does not play coded files such as DRM.
- The unit can recognize the following files or folders in USB devices:
 - up to folders in the 11th layer (including the root folder)
 - up to 998 files/folders in a single layer
- Some USB devices may not work with this unit.
- The unit can recognize Mass Storage Class (MSC) devices.

Compatible USB device

Mass Storage Class, High-speed type

Maximum current

Note

- The unit is unable to read data other than that saved in the first partition of a USB device.
- When formatting a USB device, be sure to format using the model itself or the dedicated formatting software for that model.
- When connecting a USB device to the unit, be sure to connect after the display “Creating Library” or “Creating Database” on the USB device has disappeared.

Multi Channel AV Receiver/Multi Channel AV Amplifier
STR-AN1000/TA-AN1000

Notes on USB devices

- Do not remove a USB device during operation. To avoid data corruption and damage to the USB device, switch the unit to standby mode when removing a USB device.
- Do not connect a USB device to the unit through a USB hub.
- The unit can recognize the following files or folders in USB devices:
 - up to folders in the 11th layer (including the root folder)
 - up to 998 files/folders in a single layer

The maximum number of files and folders may vary depending on the file and folder structure. Do not save other types of files or unnecessary folders on a USB device.

- Compatibility with all encoding/writing software, recording devices, and recording media cannot be guaranteed. Incompatible USB devices may produce noise or interrupted audio or may not play at all.
- Some time may be needed to start playback when:
 - the folder structure is complex.
 - the memory capacity is excessive.
- This unit does not necessarily support all of the functions provided in a connected USB device.
- The playback order for the unit may differ from the playback order of the connected USB device.
- If a folder that has no files is selected, [There is no playable file.] appears.
- When playing a very long track or a track with a large file size, some operations may cause delays in playback.

Multi Channel AV Receiver/Multi Channel AV Amplifier
STR-AN1000/TA-AN1000

Listening to FM radio (for US, Canadian, and Asia-Pacific models only)

You can listen to FM broadcasts through the built-in tuner. Be sure that the TV and FM antenna (aerial) is connected to the unit before performing this operation.

1 Select [Listen] - [FM TUNER] from the home menu.

The FM screen appears.

FM screen

You can select and operate each item on the screen by pressing **▲** (up)/**▼** (down)/**◀** (left)/**▶** (right) and **⊕** (enter).



A: Frequency indication

Shows the frequency of the station which the tuner is receiving.

B: Preset station list

You can tune to a station by selecting the preset number from the list.

Hint

- You can also display the FM screen by pressing OTHERS to select FM.
- If you have already preset stations, you can select the station you want through the following operation:
 - Press **▲** (up)/**▼** (down) (or PRESET +/-) repeatedly to select the station.
- You can perform auto-tuning through the following operations:
 1. Press **◀** (left) to move the highlight to the current frequency indication.
 2. Press **▲** (up)/**▼** (down).
- You can perform direct tuning through the following operations:
 1. Press **◀** (left) to move the highlight to the current frequency indication, and then **⊕** (enter).
 2. Press **◀** (left)/ **▶** (right) to select a digit, and **▲** (up)/**▼** (down) to change the digit.
- You can perform the following operations from the options menu that is displayed when you press OPTIONS:
 - Preset Memory
 - Preset Name Input (When highlighted in the preset list)
 - Switching [FM Mode]

- Connecting the antenna (aerial) (for US, Canadian, and Asia-Pacific models only)
- Tuning to a station directly (Direct Tuning) (for US, Canadian, and Asia-Pacific models only)
- Presetting FM radio stations (Preset Memory) (for US, Canadian, and Asia-Pacific models only)
- Naming preset stations (Preset Name Input) (for US, Canadian, and Asia-Pacific models only)
- The FM stereo reception is poor (for US, Canadian, and Asia-Pacific models only).

5-037-030-11(5) Copyright 2022 Sony Corporation

Presetting FM radio stations (Preset Memory) (for US, Canadian, and Asia-Pacific models only)

You can store up to 30 FM stations as your favorite stations.

- 1 Select [Listen] - [FM TUNER] from the home menu.

The FM screen appears.

- 2 Press **←** (left) to move the highlight to the current frequency indication, and then **⊕** (enter).

- 3 Tune to the station that you want to preset.

Press **←** (left)/**→** (right) to select a digit, and **↑** (up)/**↓** (down) to change the digit.

- 4 Press **→** (right) to move the highlight to the preset list, and press **↑** (up)/**↓** (down) to select the preset number you want to store the station to.

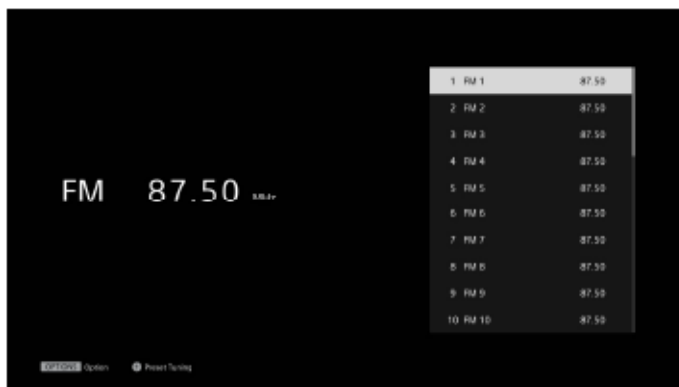

- 5 Press **OPTIONS**.

- 6 Select [Preset Memory] from the options menu.

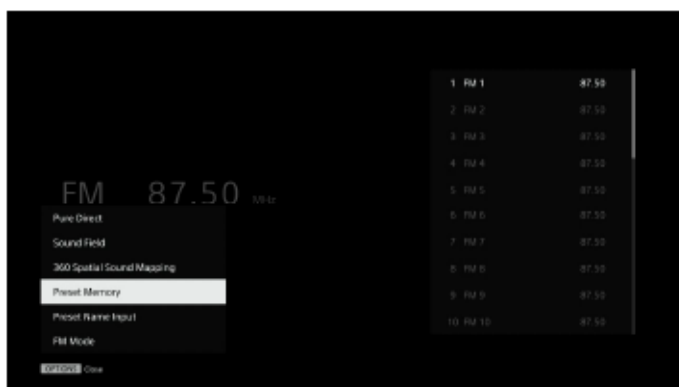

The station is stored as the selected preset number.

- 7 Repeat steps 2 to 6 to store another station.

You can store FM stations from FM 1 to FM 30.

Listening to the preset station

On the FM screen, press **➡** (right) to move the highlight to the preset list and select the station you want to listen to.

Related Topic







- [Naming preset stations \(Preset Name Input\) \(for US, Canadian, and Asia-Pacific models only\)](#)

5-037-030-11(5) Copyright 2022 Sony Corporation

Multi Channel AV Receiver/Multi Channel AV Amplifier
STR-AN1000/TA-AN1000

Naming preset stations (Preset Name Input) (for US, Canadian, and Asia-Pacific models only)

You can change the name of the registered FM station.

- 1 Select [Listen] - [FM TUNER] from the home menu.**
- 2 Press  (up)/  (down) to select the preset number to which you want to assign a name.**
- 3 Press OPTIONS.**
The options menu appears.
- 4 Select [Preset Name Input].**
An on-screen keyboard appears on the TV screen.
- 5 Press  (up)/ (down)/ (left)/ (right) and  (enter) to select characters one by one to enter the name.**
- 6 Select [Enter].**
The name you entered is registered.

Canceling naming input

Press BACK before Step 6.

Note

- Some letters that can be displayed on the TV screen cannot be displayed on the display panel.

Related Topic

- [Presetting FM radio stations \(Preset Memory\) \(for US, Canadian, and Asia-Pacific models only\)](#)

Multi Channel AV Receiver/Multi Channel AV Amplifier
STR-AN1000/TA-AN1000

Tuning to a station directly (Direct Tuning) (for US, Canadian, and Asia-Pacific models only)

You can enter the frequency of a station directly.

- 1 Select [Listen] - [FM TUNER] from the home menu.
- 2 Press **←** (left) to move the highlight to the current frequency indication, and then **⊕** (enter).
- 3 Press **↑** (up)/**↓** (down)/**←** (left)/**→** (right) to enter the frequency.
 1. Press **←** (left)/**→** (right) to select a digit.
 2. Press **↑** (up)/**↓** (down) to change the digit.
- 4 Press **⊕** (enter).

Note

- If the tuned frequency is invalid or out of range, [---.--- MHz] appears and then the screen returns to the current frequency. Make sure you have entered the right frequency. If not, repeat steps 3 and 4. If you still cannot tune to a station, the frequency may not be in use in your area.

Hint

- The tuning scale for direct tuning is shown below:
 - **US and Canadian models:**
100 kHz
 - **Other countries and region models:**
50 kHz

Multi Channel AV Receiver/Multi Channel AV Amplifier
STR-AN1000/TA-AN1000

Receiving RDS broadcasts (for Asia-Pacific models only)

This unit allows you to use Radio Data System (RDS), which enables FM radio stations (*) to send additional information along with the regular programming signal. This unit offers convenient RDS features, such as Program Service name display.

* Not all FM stations provide RDS service, nor do they provide the same type of services. If you are not familiar with the RDS services in your area, check with your local radio stations for details.

1 Select [Listen] - [FM TUNER] from the home menu.

2 Select a station.

When you tune to a station that provides RDS services, the Program Service name appears on the display panel.

Note

- RDS may not work properly if the station you tuned to does not transmit the RDS signal or if the signal strength is weak.
- Some letters that can be displayed on the TV screen cannot be displayed on the display panel.

Hint

- You can check the frequency while a Program Service name is displayed by pressing DISPLAY MODE on the unit repeatedly.

Multi Channel AV Receiver/Multi Channel AV Amplifier
STR-AN1000/TA-AN1000

What you can do with BLUETOOTH® features

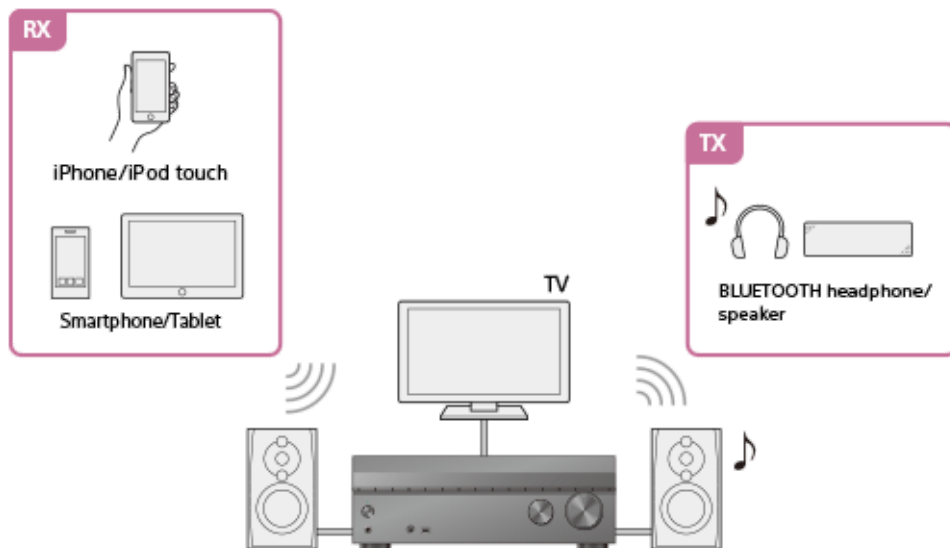

- **RX (receiver mode)**

Listening to audio/music content of a BLUETOOTH device by sending it to the unit

You can enjoy audio/music content stored on your iPhone/iPod touch, smartphone, or tablet that support the BLUETOOTH function by sending it to the unit.

[Enjoying audio content using the BLUETOOTH function \(Pairing operation\)](#)

- **TX (transmitter mode)**

Listening to sound transmitted from an AV device connected to the unit with the BLUETOOTH receiver (headphones/speakers)

You can enjoy the sound of an AV device connected to the unit with BLUETOOTH headphones or BLUETOOTH speakers. If the sound is interrupted, move the BLUETOOTH receiver closer to this unit.

[Listening with BLUETOOTH headphones/speakers \(Pairing operation\)](#)

For details about the compatible BLUETOOTH version and profiles of this unit, see "[Compatible BLUETOOTH version and profiles.](#)"

Multi Channel AV Receiver/Multi Channel AV Amplifier
STR-AN1000/TA-AN1000

Compatible BLUETOOTH version and profiles

“Profile” refers to a standard set of capabilities for various BLUETOOTH product capabilities. This unit supports the following BLUETOOTH version and profiles:

- **Compatible BLUETOOTH version:** BLUETOOTH Specification Version 5.0
- **Compatible BLUETOOTH profiles:**
 - A2DP (Advanced Audio Distribution Profile): transmits and receives high-quality audio/music content.
 - AVRCP (Audio Video Remote Control Profile): controls audio/video devices (pausing, stopping, starting playback, volume control, etc.)

For the latest information about compatible BLUETOOTH devices, check the websites listed under “[Customer support websites](#).”

Note

- The functions may differ depending on the specifications of the BLUETOOTH device.
- In the BLUETOOTH wireless connection, audio data and signals for operation are transmitted and received for processing between the BLUETOOTH device and this unit. So the response to the operation may be delayed, or there may be a delay before the start of playback unlike the case of playback on the BLUETOOTH device itself.

Multi Channel AV Receiver/Multi Channel AV Amplifier
STR-AN1000/TA-AN1000

Enjoying audio content using the BLUETOOTH function (Pairing operation)

Pairing is an operation where BLUETOOTH devices are registered to each other before connection. Once a pairing operation is performed, it does not need to be performed again. Be sure to set the [Bluetooth Mode] to [Receiver] before pairing a device with this unit.

1 Place the BLUETOOTH device within 1 meter (3.3 feet) of the unit.

2 Press and hold BLUETOOTH on the unit to select the BLUETOOTH function.

[PAIRING] flashes on the display panel.

3 Perform pairing on the BLUETOOTH device to detect this unit.

For details, refer to the operating instructions of your BLUETOOTH device.

A list of detected devices may appear on the BLUETOOTH device display depending on the type of BLUETOOTH device. This unit is displayed as [STR-AN1000]/[TA-AN1000].

4 Select [STR-AN1000]/[TA-AN1000] on the BLUETOOTH device display.

If [STR-AN1000]/[TA-AN1000] is not displayed, repeat this process from step 1.

When the BLUETOOTH connection is established, the paired device name appears and [BT] lights up on the display panel.

5 Start playback on the BLUETOOTH device.

6 Adjust the volume.

Adjust the volume of the BLUETOOTH device first. If the volume level is still too low, adjust the volume level of the unit.

Canceling pairing operation

Pairing operation will be canceled when you switch the input.

Note

- Some applications of BLUETOOTH device cannot be controlled from the unit.
- If a passkey is required on the display of the BLUETOOTH device in step 4, enter [0000]. The passkey may be called "Passcode," "PIN code," "PIN number" or "Password."
- You can pair up to 10 BLUETOOTH devices. If a 11th BLUETOOTH device is paired, the least recently connected device will be replaced by the new one.
- BLUETOOTH on the unit does not work when the [Bluetooth Mode] is set to [Off].

Hint

- You can change the name of the unit that appears on your device in [Device Name Setting] in the [System Settings] menu.

Related Topic

- [Controlling a BLUETOOTH device using the remote control](#)

5-037-030-11(5) Copyright 2022 Sony Corporation

Multi Channel AV Receiver/Multi Channel AV Amplifier
STR-AN1000/TA-AN1000

Controlling a BLUETOOTH device using the remote control

You can operate the BLUETOOTH device with the following buttons on the remote control.

- **▶|| (play/pause) (*)** : starts or pauses playback.
- **◀◀/▶▶ (previous/next)**: jumps to the beginning of the previous track or next track.

* When you press **▶|| (play/pause)** button while no BLUETOOTH device is connected, the unit will automatically connect to the last connected BLUETOOTH device.

Note

- These operations may not work with certain BLUETOOTH devices. Also, the actual operation may differ depending on the BLUETOOTH device you are using.
- The BLUETOOTH TX/RX on the remote control does not work when the BLUETOOTH function is already activated or when [Bluetooth Mode] is set to [Off].

Multi Channel AV Receiver/Multi Channel AV Amplifier
STR-AN1000/TA-AN1000

Listening with BLUETOOTH headphones/speakers (Pairing operation)

You can listen to audio sources playing via this unit by using BLUETOOTH headphones/speakers.

- 1 Select [Setup] - [Bluetooth Settings] from the home menu.
- 2 Set [Bluetooth Mode] to [Transmitter].
- 3 Turn on the BLUETOOTH headphones/speakers and set them to pairing mode.
- 4 Select the name of the headphones or speakers from the [Device List] in the [Bluetooth Settings] menu.

If you cannot find your device name in the list, select [Scan].

After [CONNECTING] flashes and the name of the headphone or speaker is displayed on the display panel, pairing is complete.



* "XXXXXX" represents the name of a detected BLUETOOTH device.

- 5 Press one of the input buttons to select the input you want.

The sound is output from the BLUETOOTH headphones/speakers. No sound is output from the unit.

- 6 Adjust the volume of the BLUETOOTH headphones/speakers.

Volume control on the unit and remote control only works for the BLUETOOTH headphones/speakers.

Note

- The BLUETOOTH device will be reconnected when [Bluetooth Mode] is changed from [Receiver] to [Transmitter]. Press BLUETOOTH TX/RX on the remote control to reconnect quickly.
- You can also press BLUETOOTH TX/RX on the remote control to switch [Bluetooth Mode]. However, you cannot switch [Bluetooth Mode] when [NOT USE] appears on the display panel. Check if you are already using the Bluetooth function.
- When a headphone is connected to the PHONES jack, BLUETOOTH headphones/speakers cannot be connected.
- You may not be able to adjust the volume level depending on the BLUETOOTH receiver.
- When [Bluetooth Audio] is selected as an input, you cannot set [Bluetooth Mode] to [Transmitter].
- You can register up to 10 sets of BLUETOOTH device. If a 11th set of BLUETOOTH device is registered, the least recently connected BLUETOOTH device will be replaced by the new ones.
- This unit can display up to 15 detected BLUETOOTH devices in the [Device List].
- You cannot change the settings of [Sound Field] and [360 Spatial Sound Mapping] in the options menu while transmitting sound.

- Some content cannot be output due to copyright protection.
- The audio output from the BLUETOOTH receiver may be delayed compared to that from this unit because of the characteristics of BLUETOOTH wireless technology.
- Audio cannot be output to BLUETOOTH devices that do not support SCMS-T.
- No sound is output from the speakers or HDMI OUT jacks when BLUETOOTH receiver is successfully connected to this unit.
- The [Bluetooth Audio] and Home Theatre Control functions are disabled when [Bluetooth Mode] is set to [Transmitter].
- If you connect a BLUETOOTH device during streaming playback, playback will stop. If you connect a BLUETOOTH device while playing music from a USB device, playback will pause.

Hint

- If the BLUETOOTH device in step 3 is the most recently connected device, you can connect it to this unit automatically by simply pressing BLUETOOTH TX/RX on the remote control. In this case, you do not need to perform step 4.

Related Topic

- [Selecting the BLUETOOTH mode \(Bluetooth Mode\)](#)
- [Checking the BLUETOOTH device list \(Device List\)](#)

5-037-030-11(5) Copyright 2022 Sony Corporation

Multi Channel AV Receiver/Multi Channel AV Amplifier
STR-AN1000/TA-AN1000

What you can do with network features

You can enjoy playing back audio content in high-quality audio from a computer or network HDD, or iPhone/iPad/iPod touch or other smartphone or tablet connected to your home network either wired or wirelessly. You can playback streaming music on the unit by operating your smartphone with a streaming service-compatible app installed.

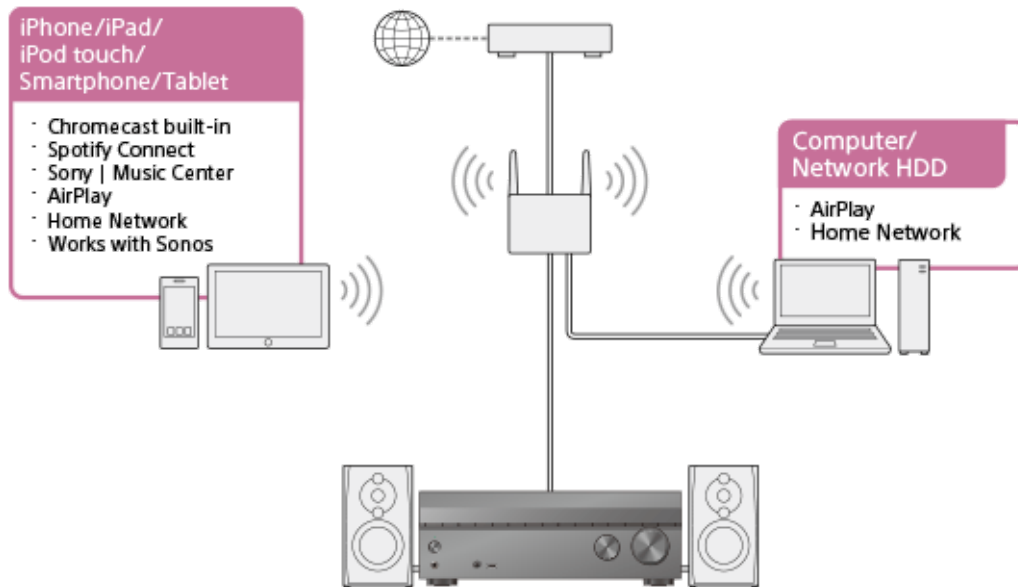

- **Chromecast built-in™**

You can select music on the Chromecast-enabled app and play it on the unit. You can also play 360 Reality Audio content on the unit.

Prerequisite: [Making the Initial Settings for Chromecast built-in](#)

- **Spotify Connect**

You can select music on the Spotify app and play it on the unit.

Use your phone, tablet or computer as a remote control for Spotify. Go to spotify.com/connect to learn how.

[Using Spotify](#)

- **Sony | Music Center**

You can control your unit wirelessly using the “Sony | Music Center” app.

[Using Sony | Music Center](#)

- **AirPlay**

This unit supports AirPlay. You can enjoy audio content from an iPhone/iPad/iPod touch or your iTunes Library.

[Enjoying audio content from iTunes or an iPhone/iPad/iPod touch via the network \(AirPlay\)](#)

- **Home network**

You can play content on the server device on your home network.

[Listening to music on your PC via a home network](#)

- **Works with Sonos**

You can play Sonos sound source/music content on the unit using the Sonos app.
[Playing music on the Sonos devices](#)

Related Topic

- [Enjoying audio content from iTunes or an iPhone/iPad/iPod touch via the network \(AirPlay\)](#)
- [Using Spotify](#)

5-037-030-11(5) Copyright 2022 Sony Corporation

Multi Channel AV Receiver/Multi Channel AV Amplifier
STR-AN1000/TA-AN1000

Notes on connecting to the Internet

Caution of the internet use without the router

When connecting the unit to the Internet, be sure to connect via a router (*1) with the appropriate security settings. Once a security issue occurs, this product may suffer damage caused by malware (malicious software), etc. via the Internet and be exposed to security threats such as theft or tampering of personal information or content. This product may also cause damage to network services without your knowledge.

*1 A router is a device that relays the Internet and a local area network connection to other devices. There are the following types of routers:

- Wired router
- ADSL modem router
- Optical Network Unit (ONU) with router function
- Wi-Fi access point that can function as a router
- In-wall access point router (*2)

*2 If you are not sure whether an in-wall access point can be used as a router, check with your apartment manager or Internet service provider, etc.

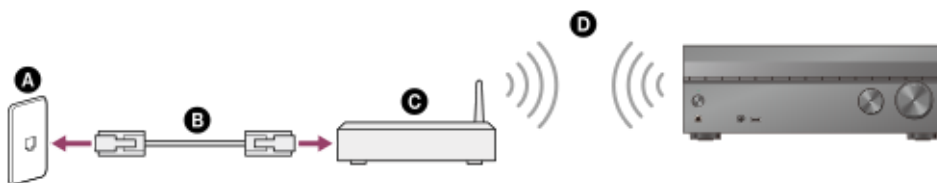

- A LAN port on the wall
- B LAN cable
- C Router
- D Wireless LAN

Multi Channel AV Receiver/Multi Channel AV Amplifier
STR-AN1000/TA-AN1000

Connecting a LAN cable (for wired LAN connections only)

We recommend that you connect the server to the router with a wired connection. Connect the unit to the network using a LAN cable (*) (not supplied).

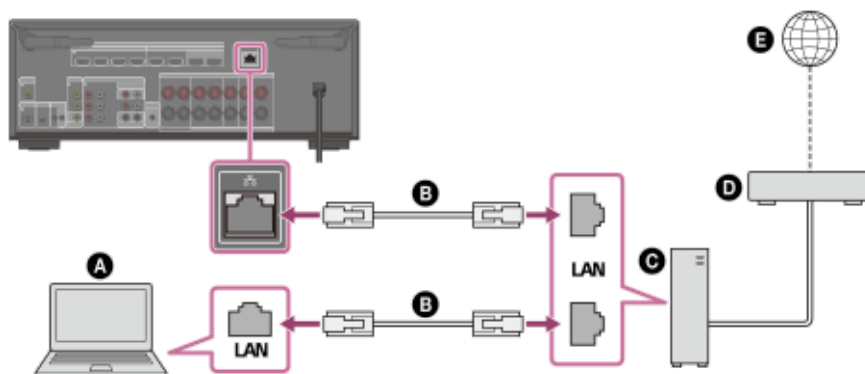

- A** Server (computer, etc.)
- B** LAN cable (*) (not supplied)
- C** Router
- D** Modem
- E** Internet

* We recommend using category 7 cables.

Hint

- Use a router compatible with transmission speeds of 100 Mbps or greater.
- We recommend that you use a router equipped with a built-in DHCP (Dynamic Host Configuration Protocol) server because the default setting on the unit is DHCP. This function automatically assigns IP addresses to devices on the LAN.
- We recommend using a normal shielded type cable for a wired LAN to avoid electric noise. Some flat-type LAN cables are easily affected by noise. We recommend using a Category 7 cable.

Related Topic

- [Notes on connecting cables](#)
- [Setting up a wired LAN connection](#)
- [Assigning a name to the unit \(Device Name Setting\)](#)

Multi Channel AV Receiver/Multi Channel AV Amplifier
STR-AN1000/TA-AN1000

Setting up a wired LAN connection

You can set up a wired LAN connection by the following procedure. Connect the unit and the router with a LAN cable beforehand.

- 1 Select **[Setup]** - **[Network Settings]** from the home menu.
- 2 Select **[Internet Settings]**.
- 3 Select **[Next]** when **[LAN cable connection was detected. Perform Wired LAN setup.]** appears.
- 4 Select **[Auto]** on the TV screen for the IP address acquisition method.
To set the IP address manually, select **[Manual]** and follow the on-screen instructions.
The network settings are displayed on the TV screen.
- 5 Press **➡** (right).
- 6 Select **[Save & Connect]**.
The unit starts connecting to the network.
When the unit is successfully connected to the network, **[NETWORK]** lights up on the display panel of the unit.

Hint

- See **[Network Connection Status]** in the **[Network Settings]** menu when checking the network settings.

Related Topic

- [Connecting a LAN cable \(for wired LAN connections only\)](#)

Multi Channel AV Receiver/Multi Channel AV Amplifier
STR-AN1000/TA-AN1000

Connecting the unit to the network using the wireless LAN antenna (for wireless LAN connections only)

When using a wireless connection, stand up both wireless LAN antennas for better performance.

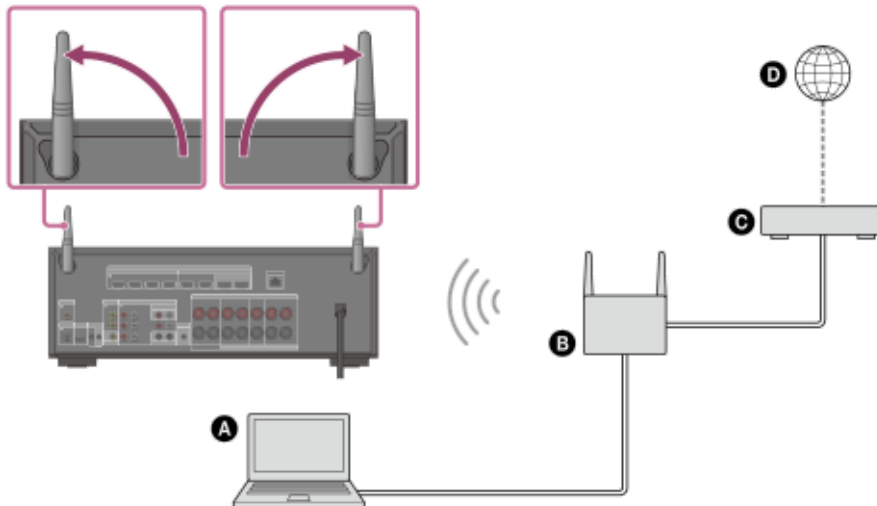

- A** Server (computer, etc.)
- B** Router
- C** Modem
- D** Internet

Note

- Audio playback on a server may occasionally be interrupted if you use a wireless connection.

Related Topic

- [Assigning a name to the unit \(Device Name Setting\)](#)

Multi Channel AV Receiver/Multi Channel AV Amplifier
STR-AN1000/TA-AN1000

Setting up a wireless LAN connection

Please confirm the following information before starting the network settings.

- The network name (SSID) (*1) of the wireless LAN router/access point
- The security key (passkey) (*2) for the network

*1 SSID (Service Set Identifier) is a name that identifies a particular access point.

*2 This information should be available from a label on your wireless LAN router/access point, from the operating instructions, from the person who set up your wireless network, or from the information provided by your Internet service provider.

1 Select [Setup] - [Network Settings] from the home menu.

2 Select [Internet Settings].

3 Select [Next] when [Perform Wi-Fi setup.] is displayed on the TV screen.

A list of network names (SSID) is displayed on the TV screen.

4 Select a network name (SSID).

The unit starts connecting to the network.

To connect to a network not listed, select [New connection registration] and follow the on-screen instructions.

5 Confirm the connection result displayed on the TV screen.

When the unit is successfully connected to the network, [NETWORK] lights up on the display panel of the unit.

If the connection to the network has failed, select [Advanced Settings], and then follow the on-screen instructions to set the network name (SSID), wireless LAN router security method, and IP address.

Hint

- See [Network Connection Status] in the [Network Settings] menu when checking the network settings.

Related Topic

- [Connecting the unit to the network using the wireless LAN antenna \(for wireless LAN connections only\)](#)

Multi Channel AV Receiver/Multi Channel AV Amplifier
STR-AN1000/TA-AN1000

Setting up a Wireless Network Connection Using Sony | Music Center

The Sony | Music Center app allows you to connect the unit to the same network with your mobile device. For details, see the Help in the Sony | Music Center app or visit the following URL.

<https://www.sony.net/smcqa/>

Multi Channel AV Receiver/Multi Channel AV Amplifier
STR-AN1000/TA-AN1000

Playing music with the TIDAL App

By operating a smartphone/iPhone on which the TIDAL app is installed, you can play music from TIDAL. You can play 360 Reality Audio compatible music available on TIDAL as well. To play 360 Reality Audio compatible music, you need to subscribe to the TIDAL HiFi plan.

Note

- TIDAL may not be available in some languages or countries/regions.
- To download the app and use network services, additional registrations and payment of communication charges and other fees may be required.

1 Download and install the TIDAL app on your smartphone/iPhone.



2 Connect the mobile device by Wi-Fi to the same network as that of the unit.

3 Start the TIDAL app and select music of your choice for playback.

4 Tap the cast icon ().

5 Select the unit as the music playback destination.

Tap the name of the unit ([STR-AN1000]/[TA-AN1000] or the device name you specified in the initial settings for Google Home). When you select either 2-channel audio or 360 Reality Audio compatible music, [360RAcast] appears.

Note

- With Sony | Music Center, you can check the streaming services that provide 360 Reality Audio compatible music. On Sony | Music Center, select the unit and then select [Settings] - [About 360 Reality Audio] - [Next].
- The specifications and design of the app may change without notice.

Multi Channel AV Receiver/Multi Channel AV Amplifier
STR-AN1000/TA-AN1000

Prerequisite: Making the Initial Settings for Chromecast built-in

The unit is compatible with Chromecast built-in, which can stream music to the unit from the mobile device.

1 Select [Listen] - [Chromecast built-in] from the home menu.

Follow the on-screen instructions to make settings to use the Chromecast built-in with the unit. After performing the settings, [Network/Bluetooth Standby] is set to [On] automatically and you can play music quickly even when the unit is in standby mode.

Playing and controlling your music with Google Assistant

This unit is compatible with a Google Assistant-enabled device with Chromecast built-in so you can control your music with your voice. Simply link the unit to the Google Home app on your mobile device. For details, refer to the Google Home app.

Multi Channel AV Receiver/Multi Channel AV Amplifier
STR-AN1000/TA-AN1000

Playing music with apps compatible with other streaming services

By operating a smartphone/iPhone on which an app compatible with a streaming service of your choice is installed, you can play 2-channel audio or 360 Reality Audio compatible music.

Depending on the streaming service, you need to subscribe to the premium plan to play 360 Reality Audio compatible music.

Note

- With Sony | Music Center, check 360 Reality Audio delivery streaming services supported by the unit. On Sony | Music Center, select the unit and then select [Settings] - [About 360 Reality Audio] - [Next].
- To download the app and use network services, additional registrations and payment of communication charges and other fees may be required.
- The specifications and design of the app may change without notice.

1 Download and install an app compatible with a streaming service of your choice on your smartphone/iPhone.

2 Connect the mobile device by Wi-Fi to the same network as that of the unit.

3 Start the app you downloaded in step 1 and select music of your choice for playback.

4 Tap the cast icon.

The cast icon varies depending on the app.

5 Select the unit as the music playback destination.

Tap the name of the unit ([STR-AN1000]/[TA-AN1000] or the device name you specified in the initial settings for Google Home).

Multi Channel AV Receiver/Multi Channel AV Amplifier
STR-AN1000/TA-AN1000

Using Spotify

You can select music on the Spotify app and play it on the unit.

Playing music on the unit by using the “Spotify Connect” function

Use your phone, tablet or computer as a remote control for Spotify. Go to spotify.com/connect to learn how.

Hint

- If [Network/Bluetooth Standby] is set to [On], you can play music quickly even when the unit is in standby mode.
- An image such as an album cover appears in the playback screen if the played content supports the feature.

Multi Channel AV Receiver/Multi Channel AV Amplifier
STR-AN1000/TA-AN1000

Using Sony | Music Center

Sony | Music Center is an application for controlling compatible Sony audio devices using the mobile device such as a smartphone or tablet.

For details about Sony | Music Center, refer to the following URL.

<https://www.sony.net/smcqa/>

- 1 **Install the free Sony | Music Center app on your mobile device.**
- 2 **Connect the mobile device via Wi-Fi to the same network as that of the unit.**
- 3 **Start Sony | Music Center.**
- 4 **Operate by following the Sony | Music Center screen.**

Note

- Use Sony | Music Center of the latest version. If you cannot connect the unit and a BLUETOOTH device via the BLUETOOTH function, uninstall Sony | Music Center and try to connect via the BLUETOOTH function again.

Hint

- Connect the mobile device to the same network as that of the unit.

Multi Channel AV Receiver/Multi Channel AV Amplifier
STR-AN1000/TA-AN1000

Enjoying audio content from iTunes or an iPhone/iPad/iPod touch via the network (AirPlay)

The unit is compatible with AirPlay 2. You can select music content on an iOS device such as iPhone, iPad, and iPod touch and stream it to the unit.

1 Connect the iOS device by Wi-Fi to the same network as that of the unit.

2 Play the music you want to stream on the iOS device.

3 Display the AirPlay icon () on the iOS device and tap it.

4 Select the unit as the speaker to stream to on the iOS device.

The music is played on the unit.

Hint

- You can also select other speakers at the same time as the unit, and stream music through multiple speakers.

Streaming music on the unit by talking to Siri

If you add the unit to the Home app on the iOS device, you can stream music to the unit by talking to Siri.

Note

- Since the unit does not have a microphone, you cannot talk to the unit to operate it.
- Not all features of Siri are available on the unit.

Multi Channel AV Receiver/Multi Channel AV Amplifier
STR-AN1000/TA-AN1000

Listening to music on your PC via a home network

You can play music files stored on your PC via your home network.

Music files can be played by operating Sony | Music Center on a mobile device such as a smartphone or tablet.

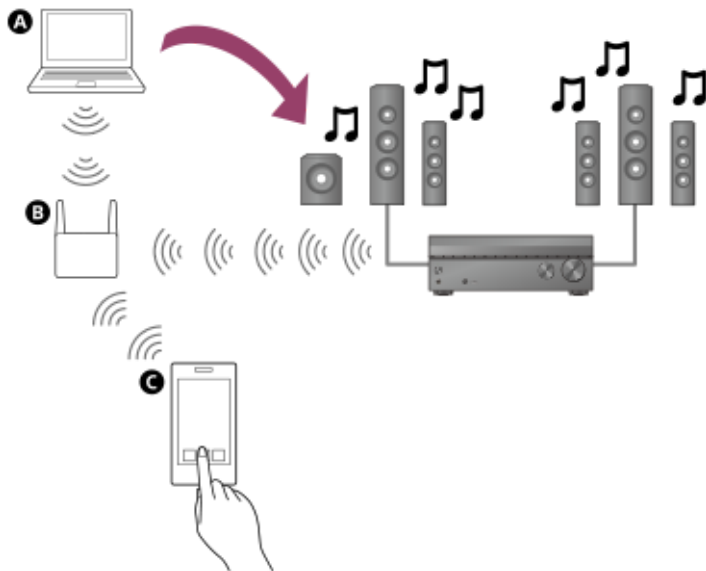

- A** PC
- B** Wireless LAN router
- C** Smartphone or tablet

1 Connect the unit to a network.

2 Connect the PC to a network.

For details, refer to the operating instructions of the PC.

3 Set the PC.

To use the PC on your home network, you need to set the PC as the server. For details, refer to the operating instructions of the PC.

4 Listen to music on a PC by using Sony | Music Center.

You can play music files stored on the PC by operating Sony | Music Center that is installed to a mobile device such as a smartphone or tablet. For details of Sony | Music Center, refer to the following URL.

<https://www.sony.net/smcqa/>

Hint

- See [Setup] - [Network Settings] - [Network Connection Status] when checking the network connection status.

- [Setting up a wireless LAN connection](#)
- [Setting up a Wireless Network Connection Using Sony | Music Center](#)

5-037-030-11(5) Copyright 2022 Sony Corporation

Multi Channel AV Receiver/Multi Channel AV Amplifier
STR-AN1000/TA-AN1000

Formats compatible with home networks

Supported music formats (*1)

MP3 (MPEG 1 Audio Layer-3):

.mp3

AAC/HE-AAC (*2):

.m4a, .aac, .mp4 (*3), .3gp (*3)

WMA9 Standard (*2):

.wma

LPCM:

.wav

FLAC (*2):

.flac

DSF (*2):

.dsf

DSDIFF (*2) (*4):

.dff

AIFF (*2):

.aiff, .aif

ALAC (*2):

.m4a

Vorbis

.ogg

Monkey's Audio

.ape

*1 Compatibility with all encoding/writing software, recording devices and recording media cannot be guaranteed.

*2 The unit may not play this file format on the home network server.

*3 The unit does not play this file format on the home network server.

*4 The unit does not play DST encoded files.

Note

- Some files may not play depending on the file format, the file encoding, the recording condition, or home network server condition.
- Some files that have been edited on a computer may not play.
- Fast forward or fast reverse functions may not be available for some files.
- The unit does not play coded files such as DRM and Lossless.
- The unit can recognize the following files or folders stored in the home network server:
 - up to folders in the 19th layer
 - up to 999 files/folders in a single layer

Multi Channel AV Receiver/Multi Channel AV Amplifier
STR-AN1000/TA-AN1000

Playing music on the Sonos devices

By setting up the unit and Sonos devices to be used in combination, you can play audio content on the Sonos devices with this unit.

1 Select [Setup] - [Network Settings] from the home menu.

2 Select [Works with Sonos].

The Sonos device on the same network is discovered.

3 Set an input source, a zone where the Sonos device is installed, and the volume level for the device.

4 Start playback of audio content on the Sonos device.

The input source is switched to the one as selected in step 3 and the audio content of the Sonos device is played back at the set volume level and in the selected zone.

For information on the operation of Sonos devices and the Sonos App, please visit the Sonos website.

What you can do with multi-zone features

- **Enjoying video and sound in two locations — Zone 2**

You can enjoy video and audio in another room by connecting a TV or different AV receiver equipped with an HDMI input jack and located in another room to the HDMI OUT B/ZONE 2 jack. For example, movies or music from an AV device located in the living room can be played at high quality in a bedroom.

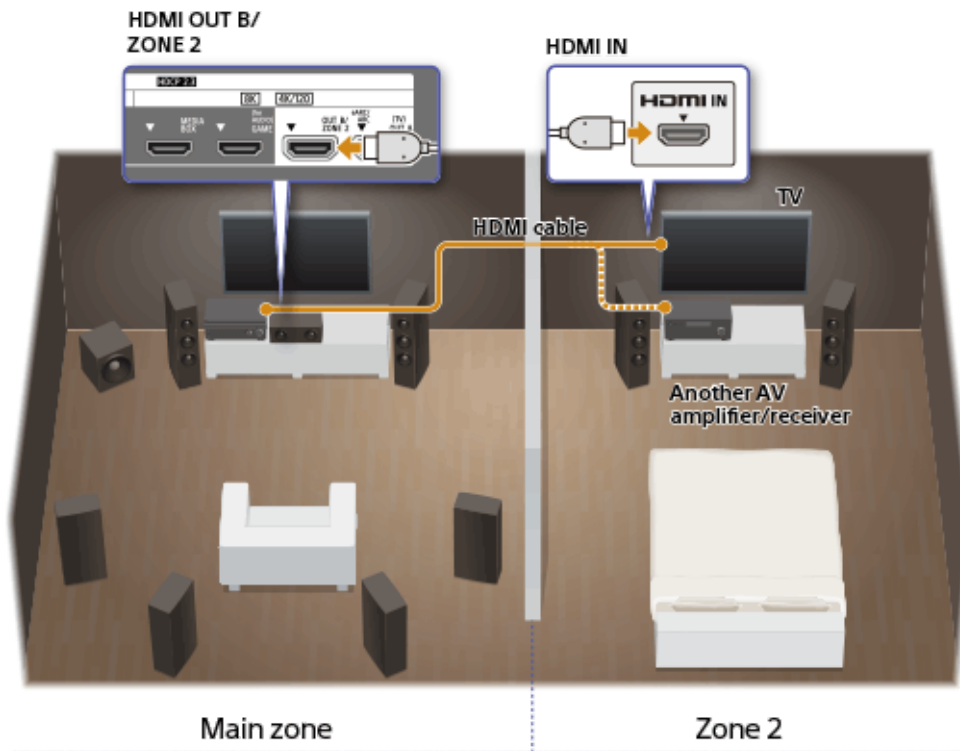

- **Listening sound in two locations — Zone 3**

You can simultaneously enjoy music in another room by connecting speakers located in the other room to the SPEAKERS SURROUND BACK/HEIGHT (FRONT B/BI-AMP/ZONE 3) terminals. For example, you can simultaneously listen to the same music from AV devices located in the living room and kitchen, or enjoy different music in the kitchen while you watch a movie in the living room.

The volume can be adjusted separately for each room.

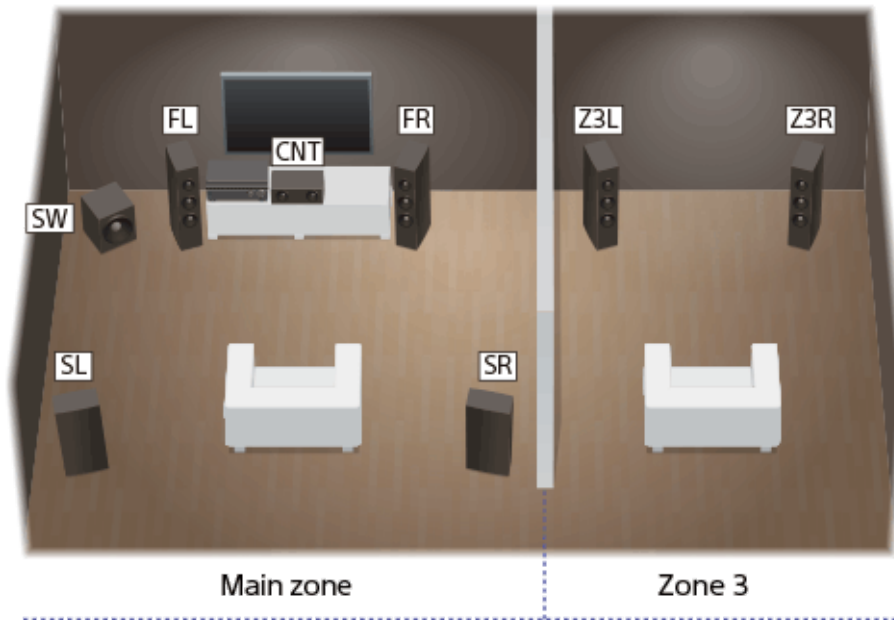

You can also install and use one more unit or amplifier in Zone 3. In this case, connect the amplifier installed in Zone 3 to the AUDIO ZONE 3 OUT jacks of the unit installed in main zone.

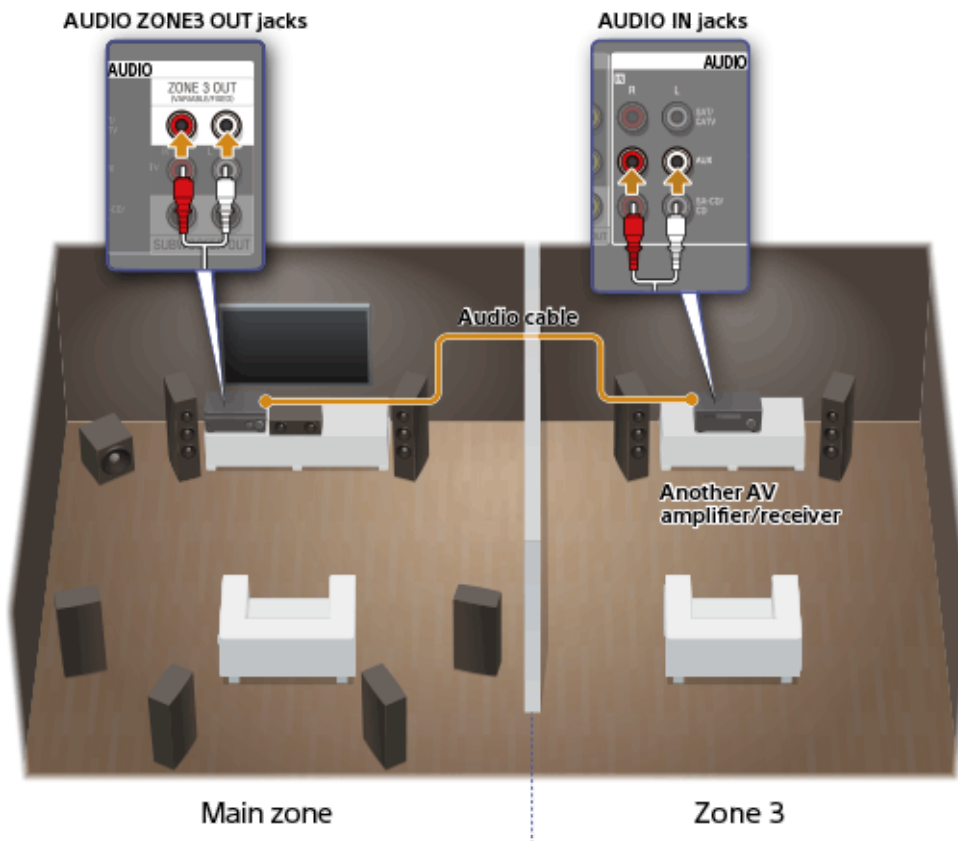

Note

- There are restrictions on the audio sources that can be used in Zone 2 or Zone 3. For details, see [“Available input sources for each zone.”](#)

Related Topic

- [Connecting 5.1-channel speaker system with Zone 3 connection](#)
- [Connecting another amplifier in Zone 3](#)
- [Enjoying sound using speakers in Zone 3](#)
- [Enjoying sound using another amplifier in Zone 3](#)
- [Connecting another amplifier or TV in Zone 2](#)

- Selecting the method to use the HDMI OUT B jack (HDMI OUT B Mode)
- Enjoying video and sound on the amplifier and TV in Zone 2

5-037-030-11(5) Copyright 2022 Sony Corporation

Available input sources for each zone

Available input sources vary depending on the zone you have selected.

Available input sources for main zone

You can select all input source from every device connected to the unit in the main zone.

| Input name | Available audio/video signals |
|--|---|
| GAME | <ul style="list-style-type: none"> ● Signals from the HDMI IN GAME (for AUDIO) jack |
| MEDIA BOX | <ul style="list-style-type: none"> ● Signals from the HDMI IN MEDIA BOX jack |
| BD/DVD | <ul style="list-style-type: none"> ● Signals from the HDMI IN BD/DVD jack |
| SAT/CATV | <ul style="list-style-type: none"> ● Signals from the HDMI IN SAT/CATV jack ● Signals from the VIDEO/AUDIO IN SAT/CATV jacks (*1) |
| VIDEO | <ul style="list-style-type: none"> ● Signals from the HDMI IN VIDEO jack |
| AUX | <ul style="list-style-type: none"> ● Signals from the VIDEO/AUDIO IN AUX jack (*2) |
| TV | <ul style="list-style-type: none"> ● eARC/ARC signals from the HDMI OUT A (TV) jack ● Signals from the DIGITAL OPTICAL IN TV jack ● Signals from the AUDIO IN TV jacks |
| SA-CD/CD | <ul style="list-style-type: none"> ● Signals from the HDMI IN SA-CD/CD jack ● Signals from the COAXIAL IN SA-CD/CD jack ● Signals from the AUDIO IN SA-CD/CD jacks |
| Bluetooth Audio | <ul style="list-style-type: none"> ● Signals received via BLUETOOTH |
| FM TUNER (for US, Canadian, and Asia-Pacific models only) | <ul style="list-style-type: none"> ● FM broadcasts received through the built-in tuner |
| USB | <ul style="list-style-type: none"> ● Signals from the  (USB) port on the front panel |
| Home Network | <ul style="list-style-type: none"> ● Signals from the devices on the home network |
| Chromecast built-in/Spotify/360 Reality Audio/AirPlay | <ul style="list-style-type: none"> ● Signals received via music services on the Internet and via mobile devices, etc. |

*1 The video signals input from the VIDEO IN SAT/CATV jack will be output from the MONITOR OUT jack.

*2 The video signals input from the VIDEO IN AUX jack will be output from the MONITOR OUT jack.

Available input sources for Zone 2

The following input sources are available for Zone 2. You can only watch video or listen to audio input from the HDMI IN jacks.

| Input name | Available audio/video signals |
|-----------------------------|---|
| GAME (*1), (*2) | <ul style="list-style-type: none">● Signals from the HDMI IN GAME (for AUDIO) jack |
| MEDIA BOX (*1), (*2) | <ul style="list-style-type: none">● Signals from the HDMI IN MEDIA BOX jack |
| BD/DVD (*1) | <ul style="list-style-type: none">● Signals from the HDMI IN BD/DVD jack |
| SAT/CATV (*1) | <ul style="list-style-type: none">● Signals from the HDMI IN SAT/CATV jacks |
| VIDEO (*1), (*2) | <ul style="list-style-type: none">● Signals from the HDMI IN VIDEO jacks |
| SA-CD/CD (*1), (*2) | <ul style="list-style-type: none">● Signals from the HDMI IN SA-CD/CD (for AUDIO) jacks |
| SOURCE (*2) | <ul style="list-style-type: none">● Signals from the current input in main zone (sources input from the HDMI IN jacks only) |

*1 You cannot select the input when [Input Mode] under [Assignment] is set to other than [Auto] in [Input Settings].

*2 When [HDMI OUT B Mode] in [HDMI Settings] is set to [Zone2], the video signals that can be played are limited as follows:

- GAME, MEDIA BOX:
up to 4K/60p 4:4:4
- VIDEO, SACD/CD:
up to 4K/60p 4:2:0

Note

- You can only playback input from the HDMI IN jacks in Zone 2. When [SOURCE] is selected, the video and sound that are input from the HDMI IN jack selected in the main zone are played.

Available input sources for Zone 3

The following input sources are available for Zone 3. You can listen to audio input from the AUDIO IN jacks, audio played in the main zone, or FM radio audio (for US, Canadian, and Asia-Pacific models only). You cannot watch video in Zone 3.

| Input name | Available audio/video signals |
|-----------------|---|
| SAT/CATV | <ul style="list-style-type: none">● Signals from the AUDIO IN SAT/CATV jack |
| AUX | <ul style="list-style-type: none">● Signals from the AUDIO IN AUX jack |
| TV | <ul style="list-style-type: none">● Signals from the AUDIO IN TV jack |

| Input name | Available audio/video signals |
|--|--|
| SA-CD/CD | <ul style="list-style-type: none"> ● Signals from the AUDIO IN SA-CD/CD jack |
| SOURCE | <ul style="list-style-type: none"> ● Signals from the current input in main zone (sound only) |
| FM TUNER (for US, Canadian, and Asia-Pacific models only) | <ul style="list-style-type: none"> ● FM broadcasts received through the built-in tuner |

Note

- To enjoy [USB], [Home Network], [Bluetooth Audio], [Chromecast built-in], [Spotify], or [AirPlay] in Zone 3, select [SOURCE] for Zone 3 input, and then switch the main zone input.
- When an external input (SAT/CATV, AUX, TV, or SA-CD/CD) is selected in Zone 3, audio of device connected to the AUDIO IN jack is played. To play the external digital input from OPTICAL IN TV jack, COAXIAL IN SA-CD/CD jack, or HDMI IN jacks, select the target input for the main zone, and then select [SOURCE] for Zone 3.
- If you set [DSD Native] in [Audio Settings] to [On], no audio signals for DSD content from [USB] or [Home Network] are output to the Zone 3 speakers.

Related Topic

- [Selecting the method to use the HDMI OUT B jack \(HDMI OUT B Mode\)](#)

Connecting another amplifier or TV in Zone 2

HDMI input video/audio signals are output in Zone 2 using the HDMI OUT B/ZONE 2 jack of the unit.
Before connecting cables, be sure to disconnect the AC power cord (mains lead).

When connecting to only TV in Zone 2

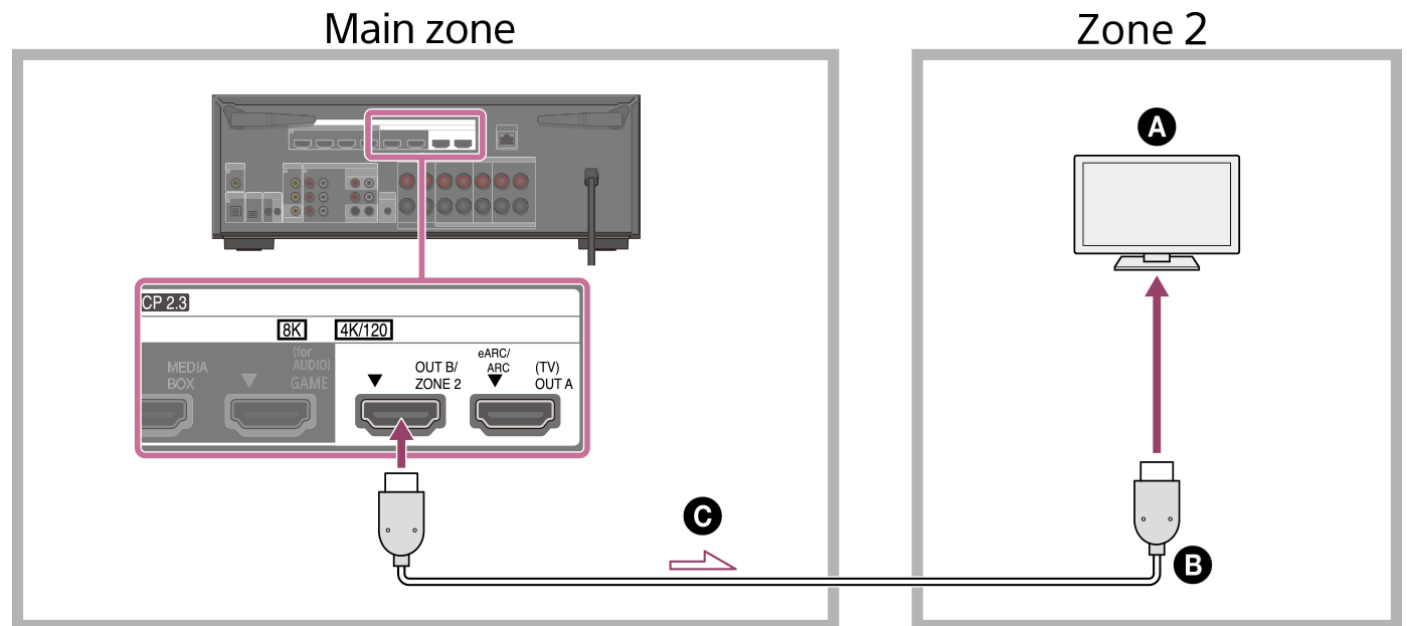

When connecting to an amplifier/receiver in Zone 2

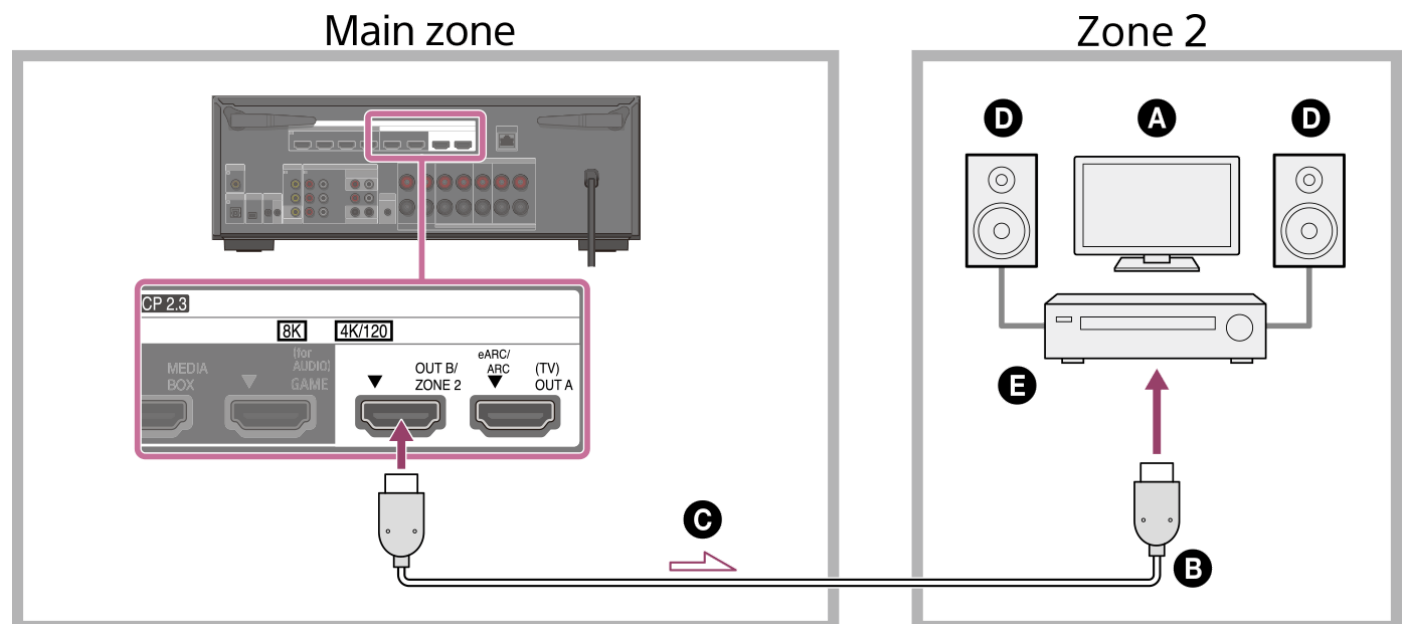

- Ⓐ TV
- Ⓑ HDMI cable (not supplied)
- Ⓒ Audio/video signals
- Ⓓ Speakers
- Ⓔ Amplifier/receiver

Note

- To use this connection, set [HDMI OUT B Mode] in the [HDMI Settings] menu to [Zone2].
- You can only playback input from the HDMI IN jacks in Zone 2. When [SOURCE] is selected, the video and sound that are input from the HDMI IN jack selected in the main zone are played.
- Since the audio signals of the input that can be selected in Zone 2 are output to the amplifier/receiver connected to the HDMI OUT B/ZONE 2 jack as they are, you cannot adjust the volume level on the unit. Adjust the volume on the amplifier/receiver connected to the HDMI OUT B/ZONE 2 jack.
- For details on selecting the Zone 2 input, see [“Enjoying video and sound on the amplifier and TV in Zone 2.”](#)

Related Topic

- [Notes on connecting cables](#)

5-037-030-11(5) Copyright 2022 Sony Corporation

Multi Channel AV Receiver/Multi Channel AV Amplifier
STR-AN1000/TA-AN1000

Setting up Zone 2 (Zone2 Settings)

- 1** Connect a TV or amplifier/receiver and speakers.
- 2** Turn on the amplifier/receiver and TV in Zone 2.
- 3** Turn on the TV and the unit in the main zone.
- 4** Select [Setup] - [Zone Settings] from the home menu.
- 5** Select [Zone2 Settings].
Follow the instructions on the TV screen to make connections and settings.
- 6** Select [Confirm changes].

Multi Channel AV Receiver/Multi Channel AV Amplifier
STR-AN1000/TA-AN1000

Enjoying video and sound on the amplifier and TV in Zone 2

You can enjoy video and sound from the unit in Zone 2 by the following procedure.

- 1 Press **ZONE 2**  (power) on the remote control.
- 2 Press **ZONE 2** on the remote control.
- 3 While **ZONE 2** on the remote control is lit in red, press the input button and select the source signal you want to output.
- 4 Start playback on the input device that you selected.
- 5 Adjust the volume on the connected device (TV or amplifier).

Hint

- You can also activate Zone 2 using ZONE SELECT and ZONE POWER on the unit.
- You can also select source signals you want to output using INPUT SELECTOR on the unit while [2. xxxx (input name)] is shown on the display panel by repeatedly pressing ZONE SELECT on the unit.
- When [HDMI OUT B Mode] in [HDMI Settings] is set to [Zone2], the video signals that can be played are limited depending on the input as follows:
 - GAME, MEDIA BOX:
up to 4K/60p 4:4:4
 - VIDEO, SACD/CD:
up to 4K/60p 4:2:0
- The only inputs from the HDMI IN jacks can be played back in Zone 2. When [SOURCE] is selected for the input, the video and sound from the HDMI IN jack currently selected in the main zone will be played back.

To exit Zone 2 function

Press **ZONE 2**  (power) on the remote control to turn off the Zone 2 power.

To exit Zone 2 operation

Select [Zone Controls] - [Zone2] - [Power] from the home menu, then select [Off].

Available inputs and functional restrictions in Zone 2

See "[Available input sources for each zone.](#)"

Hint

- A dedicated App Sony | Music Center enables easier zone operation such as changing the settings or switching the zone inputs from your smartphone or tablet.

Related Topic

- [Connecting another amplifier or TV in Zone 2](#)

5-037-030-11(5) Copyright 2022 Sony Corporation

Connecting 5.1-channel speaker system with Zone 3 connection

Connect each speaker to the SPEAKERS terminals on the rear of the unit.
Before connecting cables, be sure to disconnect the AC power cord (mains lead).
For details on how to connect speaker cables to the unit, see [“How to connect speaker cables.”](#)

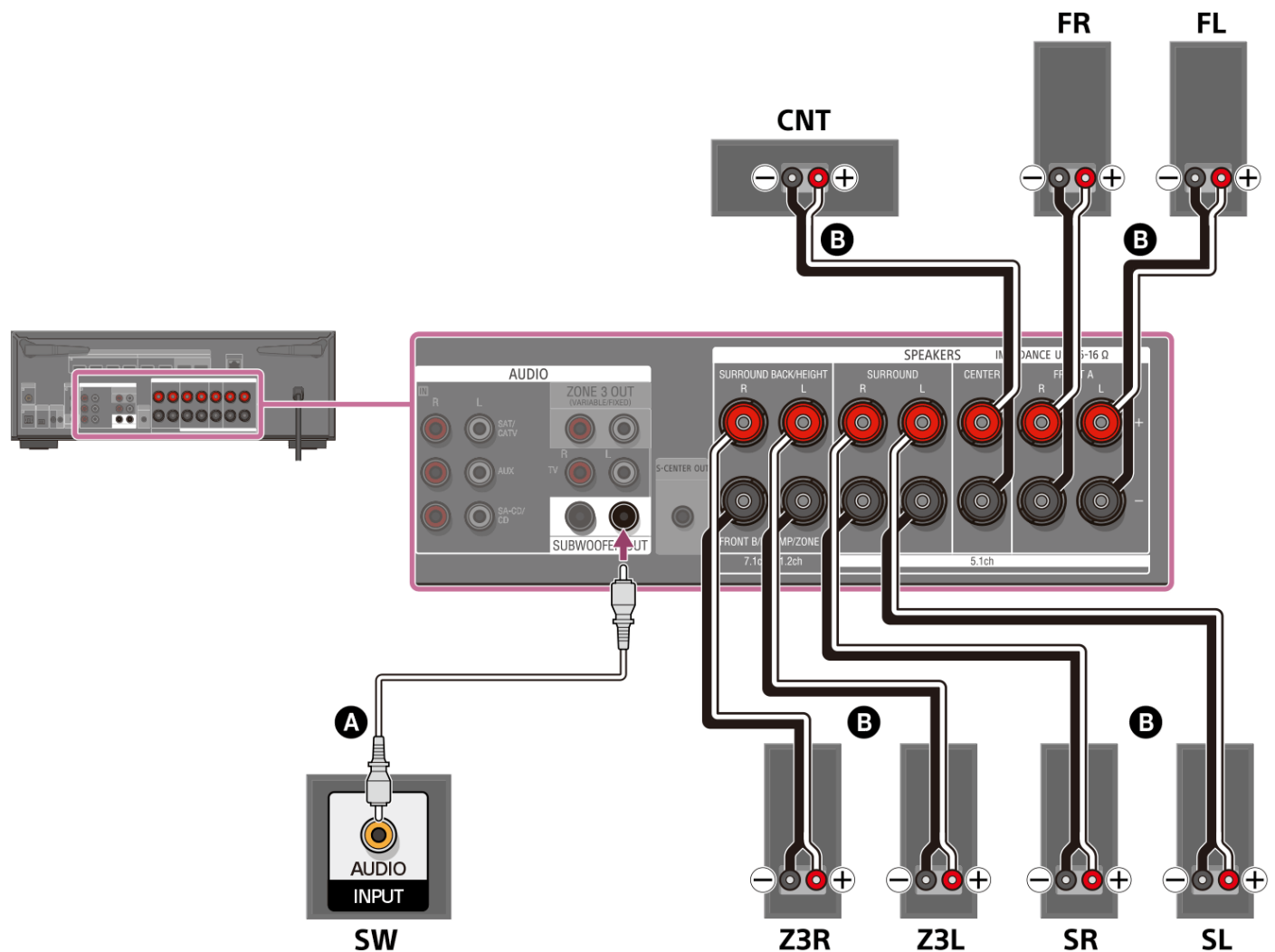

- A** Monaural audio cable (not supplied)
- B** Speaker cable (not supplied)

After you have made the Zone 3 connection, set [Surround Back Speaker Assign] in [Manual Speaker Settings] under [Speaker Settings] to [Zone3].

Note

- Connect speakers with a nominal impedance of 6 ohms to 16 ohms.
- After you have installed and connected your speakers, be sure to select the speaker pattern you want using [Speaker Pattern] in [Manual Speaker Settings] under [Speaker Settings].
- You can only set [Surround Back Speaker Assign] if the speaker pattern is set to a setting that does not have surround back and height/overhead speakers.
- To enjoy [USB], [Home Network], [Bluetooth Audio], [Chromecast built-in], [Spotify], or [AirPlay] in Zone 3, select [SOURCE] for the zone 3 input, then and switch the main zone input.

- When one of the external inputs (SAT/CATV, AUX, TV, or SA-CD/CD) is selected in Zone 3, the audio of the device connected to the AUDIO IN jack is played. To play the external digital input from the OPTICAL IN TV jack, the COAXIAL IN SA-CD/CD jack, or the HDMI IN jacks, select the target input for the main zone, and then select [SOURCE] for Zone 3.

Related Topic

- [Speaker installation example](#)
- [Installing 5.1-channel speaker system with Zone 3 connection](#)
- [Connecting 7.1-channel speaker system using surround back speakers](#)
- [Assigning the surround back speaker terminals \(Surround Back Speaker Assign\)](#)
- [Enjoying sound using speakers in Zone 3](#)
- [Notes on connecting cables](#)
- [How to connect speaker cables](#)

5-037-030-11(5) Copyright 2022 Sony Corporation

Multi Channel AV Receiver/Multi Channel AV Amplifier
STR-AN1000/TA-AN1000

Setting up Zone 3 (Zone3 Settings)

- 1** Connect a TV or amplifier/receiver and speakers.
- 2** Turn on the amplifier/receiver in Zone 3.
- 3** Turn on the TV and the unit in the main zone.
- 4** Select [Setup] - [Zone Settings] from the home menu.
- 5** Select [Zone3 Settings].
Follow the instructions on the TV screen to make connections and settings.
- 6** Select [Confirm changes].

Multi Channel AV Receiver/Multi Channel AV Amplifier
STR-AN1000/TA-AN1000

Enjoying sound using speakers in Zone 3

You can enjoy sound from the unit in Zone 3 by the following procedure.

- 1 Press ZONE 3  (power) on the remote control.**
- 2 Press ZONE 3 on the remote control.**
- 3 While ZONE 3 on the remote control is lit in red, press the input button to select the source signal you want to output.**
- 4 Start playback on the input device that you selected in step 3.**
- 5 Adjust the volume.**

Press ZONE 3 on the remote control, and press  (volume) +/- to adjust the volume while ZONE 3 on the remote control is lit in red.

Hint

- You can also activate the zone you want using ZONE SELECT and ZONE POWER on the unit.
- You can also select source signals you want to output using INPUT SELECTOR on the unit while [3. xxxx (input name)] is shown on the display panel by repeatedly pressing ZONE SELECT on the unit.
- You can also adjust the volume using MASTER VOLUME on the unit while [3. xxxx (input name)] is shown on the display panel by repeatedly pressing ZONE SELECT on the unit.
- If you want to hear the same sound as the main zone in zone 3, select [SOURCE].

To exit Zone 3 function

Press ZONE 3  (power) on the remote control to turn off the Zone 3 power.

To exit Zone 3 operation

Select [Zone Controls] - [Zone3] - [Power] from the home menu, then select [Off].

Available inputs and functional restrictions in Zone 3

See "[Available input sources for each zone.](#)"

Hint

- A dedicated App Sony | Music Center enables easier zone operation such as changing the settings or switching the zone inputs from your smartphone or tablet.

Related Topic

- [Connecting 5.1-channel speaker system with Zone 3 connection](#)

Connecting another amplifier in Zone 3

You can enjoy sound from a device connected to the unit in a zone other than the main zone. For example, you can watch a DVD in the main zone and listen to a CD in Zone 3.

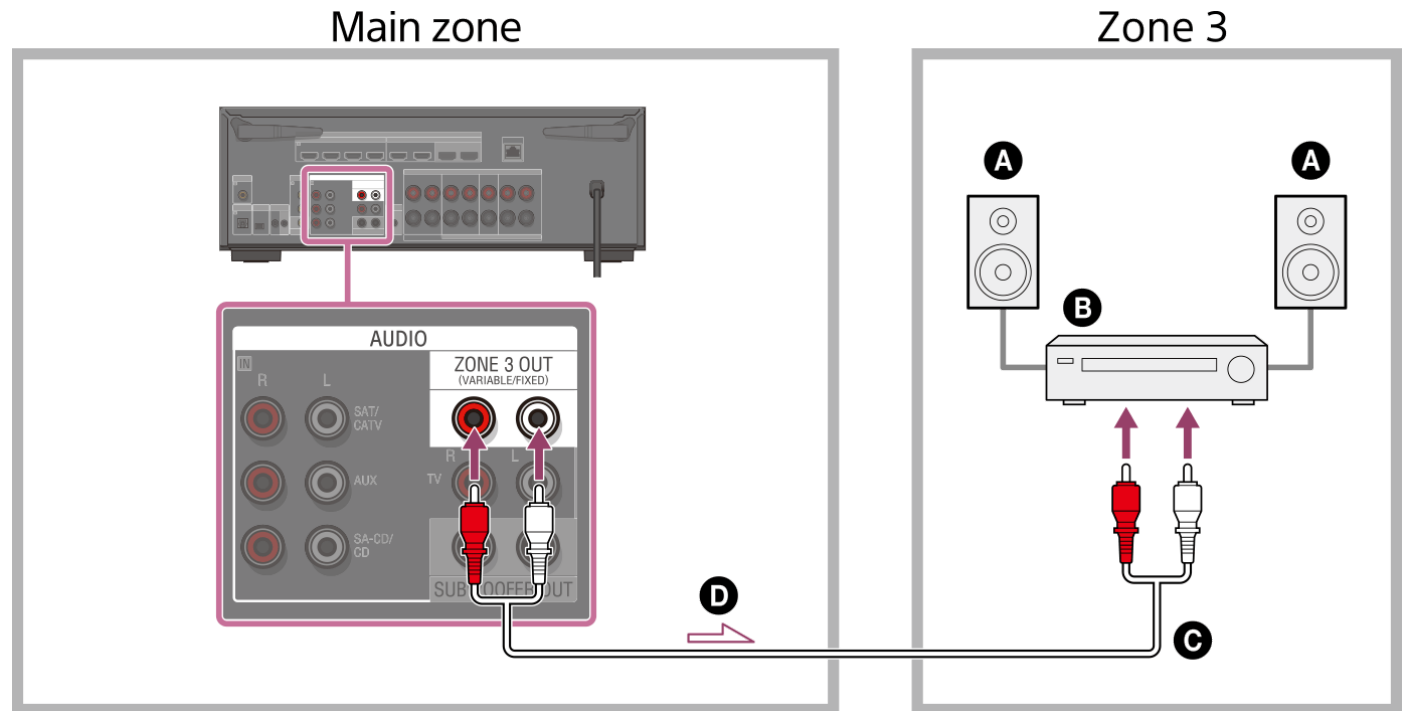

- A** Speakers
- B** Amplifier/receiver
- C** Audio cable (not supplied)
- D** Audio signals

Note

- To enjoy [USB], [Home Network], [Bluetooth Audio], [Chromecast built-in], [Spotify], or [AirPlay] in Zone 3, select [SOURCE] for the zone 3 input, then and switch the main zone input.
- You can select an input from four external inputs (SAT/CATV, AUX, TV, or SA-CD/CD), FM radio (for US, Canadian, and Asia-Pacific models only), and [SOURCE] in Zone 3. When one of the external inputs is selected, the audio of the device connected to the AUDIO IN jack is played. To play other inputs, such as Bluetooth Audio, or the external digital input from the OPTICAL IN TV jack, the COAXIAL IN SA-CD/CD jack, or the HDMI IN jacks, select the target input for the main zone, and then select [SOURCE] for Zone 3.
- If you set [DSD Native] in [Audio Settings] to [On], no audio signals for DSD content from [USB] or [Home Network] are output to the Zone 3 speakers.

Related Topic

- [Notes on connecting cables](#)

Multi Channel AV Receiver/Multi Channel AV Amplifier
STR-AN1000/TA-AN1000

Setting up Zone 3 (Zone3 Settings)

- 1** Connect a TV or amplifier/receiver and speakers.
- 2** Turn on the amplifier/receiver in Zone 3.
- 3** Turn on the TV and the unit in the main zone.
- 4** Select [Setup] - [Zone Settings] from the home menu.
- 5** Select [Zone3 Settings].
Follow the instructions on the TV screen to make connections and settings.
- 6** Select [Confirm changes].

Multi Channel AV Receiver/Multi Channel AV Amplifier
STR-AN1000/TA-AN1000

Enjoying sound using another amplifier in Zone 3

You can enjoy sound from the amplifier in Zone 3 by the following procedure.

1 Select [Zone Controls] - [Zone3] - [Power] - [On] from the home menu.

Zone 3 is activated.

2 Turn on the amplifier in Zone 3.

3 Select the input of the source signal you want to output in [Input] of [Zone3].

If you want to hear the same sound as the main zone in zone 3, select [SOURCE].

4 Start playback on the input device that you selected in step 3.

5 Adjust to a suitable volume level.

Adjust the volume level on the amplifier in Zone 3. If you set [Zone3 Line Out] in [Zone Settings] menu to [Variable], you can also adjust the volume level in Zone 3 using [Zone Controls] - [Zone3] - [Volume] from the home menu.

Hint

- You can also activate Zone 3 using ZONE SELECT and ZONE POWER on the unit.
- You can also select source signals you want to output using INPUT SELECTOR on the unit while [3. xxxx (input name)] is shown on the display panel by repeatedly pressing ZONE SELECT on the unit.
- You can also adjust volume using MASTER VOLUME on the unit while [3. xxxx (input name)] is shown on the display panel by repeatedly pressing ZONE SELECT on the unit.

To exit Zone 3 function

Press ZONE 3  (power) on the remote control to turn off the Zone 3 power.

To exit Zone 3 operation

Select [Zone Controls] - [Zone3] - [Power] from the home menu, then select [Off].

Available inputs and functional restrictions in Zone 3

See "[Available input sources for each zone.](#)"

Hint

- A dedicated App Sony | Music Center enables easier zone operation such as changing the settings or switching the zone inputs from your smartphone or tablet.

- Connecting another amplifier in Zone 3
- Setting the volume control for Zone 3 (Zone3 Line Out)

5-037-030-11(5) Copyright 2022 Sony Corporation

Multi Channel AV Receiver/Multi Channel AV Amplifier
STR-AN1000/TA-AN1000

Enjoying 360 spatial sound (360 Spatial Sound Mapping)

The 360 Spatial Sound Mapping function allows you to enjoy an amazing 360 Spatial Sound experience that makes the sound feel more spacious and as if there are more speakers in the room. In order to reproduce an accurate sound field, it is necessary to perform Auto Calibration in advance.

- 1 Select [Sound Effects] - [360SSM] from the home menu.
- 2 Select [On].

Note

- [360SSM] cannot be set to [On] unless Auto Calibration is performed.
- The speakers must be connected in the configuration of 4.0.0 channels or more.
- Perform Auto Calibration beforehand.
- When a BLUETOOTH device is connected and [Bluetooth Mode] is set to [Transmitter], [360SSM] setting cannot be used.
- This setting cannot be changed when headphones are connected.
- Select a speaker pattern that matches your speaker configuration by selecting [Manual Speaker Settings] - [Speaker Pattern] from the [Speaker Settings] menu.
- This setting is available when one of the following sound fields is selected:
 - [Multi Stereo] (except for 2-channel content)
 - [A.F.D.]
 - [A.F.D. Movie]
 - [Audio Enhancer] (except for 2-channel content)

Hint

- You can also press 360SSM on the remote control to activate or deactivate the [360 Spatial Sound Mapping] function.
- You can also select [360 Spatial Sound Mapping] from the [Audio Settings] in the [Setup] menu.

Multi Channel AV Receiver/Multi Channel AV Amplifier
STR-AN1000/TA-AN1000

Selecting a sound field (Sound Field)

You can select from a variety of sound field modes according to speaker connections or input sources.

1 Select [Sound Effects] - [Sound Field] from the home menu.

2 Select the sound field you want.

Sony recommends selecting a sound field labeled [MOVIE] for movies and a sound field labeled [MUSIC] for music. For details on each sound field, see "[Selectable sound fields and their effects.](#)"

Note

- The sound field will switch to [Headphone (2ch)] automatically when:
 - headphones are connected to the PHONES jack.
 - BLUETOOTH headphones or BLUETOOTH speakers are connected to the unit.
- The sound fields for movie or music may not work, depending on the input or the speaker pattern you select, or with audio formats.
- The unit may play signals at a lower sampling frequency than the actual sampling frequency of the input signals, depending on the audio format.
- Some speakers or the subwoofer may not output sound, depending on the sound field setting.

Hint

- You can also use 2CH/MULTI, MOVIE or MUSIC on the remote control or the unit to select a sound field.
- You can also select [Sound Field] in [Audio Settings] from the home menu.

Related Topic

- [Resetting sound fields to the default settings](#)

Selectable sound fields and their effects

| Sound field | | Display panel | Effects of the sound field |
|-------------|-------------------------------|---------------|--|
| 2CH/MULTI | 2ch Stereo | 2CH STEREO | Plays back 2-channel audio signals without adding any surround effect. Monaural and multichannel audio signals are output after being converted into a 2-channel signal. This sound field is best suited for playing back audio signals as they are from two front speakers only, without adding any virtual surround effect. The sound is output from the front left/right speakers only. There is no sound from the subwoofer. |
| | Multi Stereo | MULTI ST. | Outputs sound from all connected speakers. When 2-channel or monaural audio signals are input, the unit outputs sound from all speakers without adding any surround effect. When multi-channel audio signals are input, sound may not be output from certain speakers depending on the speaker settings or playback content. |
| | Direct | DIRECT | Plays back all audio signals without adding any surround effect. |
| | A.F.D. (Auto Format Decoding) | A.F.D. | Decodes and plays back audio signals using the optimal processing method according to the audio signal input. |
| MOVIE | A.F.D. Movie | A.F.D. MOVIE | Produces optimized (recommended) sound according to the stream. The sound is upmixed to enjoy surround at the same time. |
| | Dolby Mode | DOLBY MODE | Plays back content using Dolby upmixer or virtual technology according to the set speaker layout. |
| | DTS:X Mode | DTS:X MODE | Plays back content using DTS upmixer or virtual technology according to the set speaker layout. |
| MUSIC | Audio Enhancer | A.ENHANCER | Upscales existing sound sources to near high-resolution sound quality with DSEE Ultimate (Digital Sound Enhancement Engine Ultimate). This sound field makes you feel as if you are really at the recording studio or concert. DSEE Ultimate only works on 2-channel sound sources with a sampling frequency of 44.1 kHz or 48 kHz input from the following jacks: <ul style="list-style-type: none"> ● the HDMI IN jacks ● the HDMI OUT A (TV) jack* ● the OPTICAL IN TV jack ● the COAXIAL IN SA-CD/CD jack |

| Sound field | | Display panel | Effects of the sound field |
|-------------|-----------------|---------------|---|
| Headphones | Headphone (2ch) | HP 2CH | This mode is selected automatically when headphones are connected to the PHONES jack or BLUETOOTH headphones/BLUETOOTH speakers are connected to the unit. (Other sound fields cannot be selected in this case.) Plays back 2-channel audio signals without adding any surround effect. Sound from monaural and multi-channel audio signals are output after being converted into a 2-channel signal. |

* eARC or ARC signal input

Note

- Depending on the audio format, if you select [Direct] and play a 5.1-channel source when surround speakers and two surround back speakers are connected, the same audio as that from surround speakers will be output from surround back speakers, similar to that of a 7.1-channel surround system. The sound level of surround and surround back speakers are adjusted automatically for optimum balance.
- Atmos is decoded as Dolby TrueHD or Dolby Digital Plus when a sound field other than [Multi Stereo], [A.F.D.] or [Dolby Mode] is selected.

Relations between sound fields and speaker outputs

The list below shows which speaker outputs sound when a certain sound field is selected.

2-channel content

Meaning of symbols in the table

-: No sound is output.

⊙: Outputs sound.

○: Outputs sound depending on the speaker pattern setting and content to be played back.

●: For Dolby and DTS audio streams, outputs sound depending on the speaker pattern setting. No sound is output for Linear PCM, DSD, or AAC.

| Sound field | | Display panel | Front speakers | Center speaker | TV Center speaker | Surround speakers | Surround back speakers | Subwoofer | Height speakers |
|-------------|-------------------------------|---------------|----------------|----------------|-------------------|-------------------|------------------------|-----------|-----------------|
| 2CH/MULTI | 2ch Stereo | 2CH STEREO | ⊙ | - | - | - | - | - | - |
| | Multi Stereo | MULTI ST. | ⊙ | ○ | ○ | ○ | ○ | ○ (*1) | ○ |
| | Direct (Analog input) | DIRECT | ⊙ | - | - | - | - | - | - |
| | Direct (Others) | DIRECT | ⊙ | - | - | - | - | ○ (*2) | - |
| | A.F.D. (Auto Format Decoding) | A.F.D. | ⊙ | ● | ● | ● | ● | ○ (*2) | ● |
| MOVIE | A.F.D. Movie | A.F.D. MOVIE | ⊙ | ○ | ○ | ○ | ○ | ○ (*1) | ○ |
| | Dolby Mode | DOLBY MODE | ⊙ | ○ | ○ | ○ | ○ | ○ (*1) | ○ |
| | DTS:X Mode | DTS:X MODE | ⊙ | ○ | ○ | ○ | ○ | ○ (*1) | ○ |
| MUSIC | Audio Enhancer | A. ENHANCER | ⊙ | - | - | - | - | ○ (*2) | - |

*1 Sound is output when the following conditions are met:

- A subwoofer is connected.
- Speaker pattern with a subwoofer ([x.1]) is set.

*2 Sound is output when the following conditions are met:

- A subwoofer is connected.
- Speaker pattern with a subwoofer ([x.1]) is set.

- [Manual Speaker Settings] - [Size] in [Speaker Settings] menu is set to [Small].

Multi-channel content

Meaning of symbols in the table

-: No sound is output.

⊙: Outputs sound.

○: Outputs sound depending on the speaker pattern setting and content to be played back.

| Sound field | | Display panel | Front speakers | Center speaker | TV Center speaker | Surround speakers | Surround back speakers | Subwoofer | Height speakers |
|-------------|-------------------------------|---------------|----------------|----------------|-------------------|-------------------|------------------------|-----------|-----------------|
| 2CH/MULTI | 2ch Stereo | 2CH STEREO | ⊙ | - | - | - | - | - | - |
| | Multi Stereo | MULTI ST. | ⊙ | ○ | ○ | ○ | ○ | ○ | ○ |
| | Direct | DIRECT | ⊙ | ○ | ○ | ○ | ○ | ○ | ○ |
| | A.F.D. (Auto Format Decoding) | A.F.D. | ⊙ | ○ | ○ | ○ | ○ | ○ | ○ |
| MOVIE | A.F.D. Movie | A.F.D. MOVIE | ⊙ | ○ | ○ | ○ | ○ | ○ | ○ |
| | Dolby Mode | DOLBY MODE | ⊙ | ○ | ○ | ○ | ○ | ○ | ○ |
| | DTS:X Mode | DTS:X MODE | ⊙ | ○ | ○ | ○ | ○ | ○ | ○ |
| MUSIC | Audio Enhancer | A. ENHANCER | ⊙ | ○ | ○ | ○ | ○ | ○ | ○ |

Note

- When no sound is heard, check that all the speakers are securely connected to the correct speaker terminals and the correct speaker pattern is selected.

Multi Channel AV Receiver/Multi Channel AV Amplifier
STR-AN1000/TA-AN1000

Resetting sound fields to the default settings

Be sure to use the buttons on the unit to perform this operation.

- 1 **Hold down MUSIC and press  (power) on the unit.**

[S.F.INITIALIZED!] appears on the display panel and all sound fields are reset to their default setting.

Multi Channel AV Receiver/Multi Channel AV Amplifier
STR-AN1000/TA-AN1000

Adjusting the equalizer (Equalizer)

You can use the following parameters to adjust the tonal quality (bass/treble level) of each speaker.

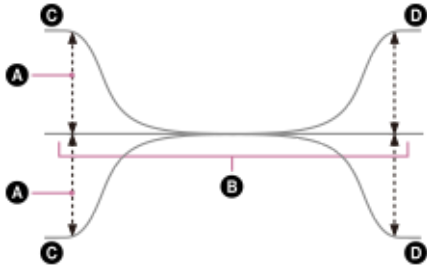

- A** Level (dB)
- B** Frequency (Hz)
- C** Bass
- D** Treble

- 1** Select [Sound Effects] - [Equalizer] from the home menu.
- 2** Select [Front], [Center], [Surround] or [Height].
- 3** Select [Bass] or [Treble].
- 4** Adjust the gain.

Note

- This function does not work in the following cases:
 - [Pure Direct] is set to [On].
 - [Bluetooth Mode] is set to [Transmitter].
 - [DSD Native] is set to [On], and the unit is playing audio signals in DSD format.
- Frequencies for [Bass] and [Treble] are fixed.
- Depending on the audio format, the unit may play signals at a lower sampling frequency than the original sampling frequency of the input signals.
- Only [Bass] gain and [Treble] gain are available for [Front] when headphones are connected.

Hint

- You can also select [Equalizer] in [Setup] - [Speaker Settings] - [Manual Speaker Settings] from the home menu.

Multi Channel AV Receiver/Multi Channel AV Amplifier
STR-AN1000/TA-AN1000

Enjoying more natural sound with speakers installed in the ceiling (In-Ceiling Speaker Mode)

Set whether or not to use [In-Ceiling Speaker Mode] with the current input.

In a setup where the front and center speakers are installed in the ceiling, lowering the audio output position to the screen height allows you to enjoy a more natural experience.

1 Select [Sound Effects] - [In-Ceiling Speaker Mode] from the home menu.

2 Select the setting you want.

- **Front & Center:** Lowers the audio output position for both the front and center speakers installed in ceiling to the screen height.
- **Front:** Lowers the audio output position for the front speakers installed in ceiling to the screen height.
- **Off:** Does not activate this function.

Note

- This function does not work in the following cases:
 - Headphones are connected.
 - [Bluetooth Mode] is set to [Transmitter].
 - [Pure Direct] is set to [On].
 - [DSD Native] is set to [On] and DSD signals are being played back.
- This function does not work if you select a sound field other than the following:
 - 2ch Stereo
 - Multi Stereo
- This function may not work depending on the audio format.
- The unit may play signals at a lower sampling frequency than the actual sampling frequency of the input signals depending on the audio format.

Hint

- You can also select [In-Ceiling Speaker Mode] from [Speaker Settings] - [TV/Screen Center Settings] in the [Setup] menu.
- To obtain optimal effects in the listening environment, set [Manual Speaker Settings] - [Height] - [Ceiling] from [Speaker Settings] menu and perform Auto Calibration.

Multi Channel AV Receiver/Multi Channel AV Amplifier
STR-AN1000/TA-AN1000

Enjoying high-fidelity sound (Pure Direct)

You can enjoy higher-fidelity sound from all inputs using the [Pure Direct] function. When the [Pure Direct] function is on, the display panel lights off to suppress noise that affects sound quality.

- 1 Select [Sound Effects] - [Pure Direct] from the home menu.
- 2 Select [On].

Canceling [Pure Direct]

The [Pure Direct] function will be canceled when you perform the following:

- Select [Off] in step 2.
- Press PURE DIRECT.
- Change the sound field.
- Change the following settings in the [Speaker Settings] menu:
 - [Auto Calibration Settings] - [Automatic Phase Matching]
 - [Auto Calibration Settings] - [Calibration Type]
 - [Manual Speaker Settings] - [Equalizer]
 - [TV/Screen Center Settings] - [In-Ceiling Speaker Mode]

Note

- [Automatic Phase Matching], [Calibration Type], [Equalizer], [In-Ceiling Speaker Mode] and [360 Spatial Sound Mapping] do not work when the [Pure Direct] function is selected.



Hint

- You can also use PURE DIRECT on the remote control or the unit to turn the [Pure Direct] function on or off.
- You can also select [Pure Direct] from [Audio Settings] in [Setup] menu.

Multi Channel AV Receiver/Multi Channel AV Amplifier
STR-AN1000/TA-AN1000

Using the DTS:X Dialog Control function

The DTS:X Dialog Control function is a function which adjusts the dialog levels during playback of the DTS:X stream. This function enables you to increase the dialog levels in contrast with the background sound and hear dialog easily even under noisy circumstances.

- 1 **Press OPTIONS.**
The options menu appears.
- 2 **Select [DTS Dialog Control].**
- 3 **Press  (up)/ (down) to adjust the dialog level.**

Note

- This function may not work depending on the audio signals.
- When you select [TV] for the input source, press AMP MENU on the remote control to set this function using the menu on the display panel.

Related Topic

- [Operating the unit with the menu on the display panel](#)

Multi Channel AV Receiver/Multi Channel AV Amplifier
STR-AN1000/TA-AN1000

Operating the unit by Interlocking with a TV (Control for HDMI function)

Connecting a TV compatible with the Control for HDMI function to the HDMI OUT A (TV) jack using an HDMI cable enables you to interlock the unit operation such as power on/off or volume adjustment with a TV.

About the Control for HDMI function

The Control for HDMI function is a function that enables operation of devices connected with an HDMI (High-Definition Multimedia Interface) cable by interlocking them.

Although this function works for devices compatible with the Control for HDMI function, it may not work if connecting devices other than those manufactured by Sony.

Preparing to operate by interlocking with a TV

Enable the Control for HDMI function settings of the TV and device connected to the unit with an HDMI cable. Set [Control for HDMI] in the [HDMI Settings] menu to [On].

Hint

- When connecting a device such as a Blu-ray Disc player to a TV with an HDMI cable, enable its Control for HDMI function.
- To enable the Control for HDMI function of a TV or Blu-ray Disc player, refer to their operating instructions.
- If you enable the Control for HDMI ("BRAVIA" sync) function when using a TV manufactured by Sony, the Control for HDMI function of the unit is also enabled automatically. When the setting is complete, [DONE] appears on the display panel.

Performing power operation or volume adjustment by a TV remote control

When turning the TV on/off or adjusting the volume using the TV remote control, the unit power operation or volume adjustment is interlocked.

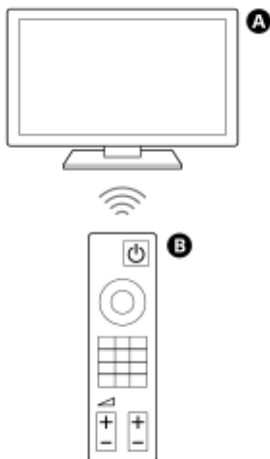

A TV

B TV remote control

Power interlocking

When you turn on or off the TV, the unit will turn on or off automatically.

Note

- If you turn off the unit before turning off the TV, the unit may not turn on automatically even though you turn on the TV next time. In this case, perform the following operation.
 - Select the unit for the sound output device in the TV menu.
 - When using Sony TV, turn on the unit while the TV is turned on.

Volume adjustment

The sound of the TV you are watching is output from the speaker connected to the unit automatically. You can adjust the unit volume by the TV remote control.

Other interlocking functions

Menu operation by TV remote control

You can operate the menu of the unit by selecting the name of the unit when changing input or operating the Sync Menu on the TV.

Note

- In the Sync Menu of the TV, the unit is recognized as “Tuner” by the TV.
- Some Sony TVs support the Sync Menu. Refer to the operating instructions of your TV to see if your TV supports the Sync Menu.

Language follow

When you change the language for the on-screen display of the TV, the unit’s on-screen display language is also changed.

Note

- If you select a language that is not supported by the unit as the on-screen display language of the TV, the unit’s on-screen display language will not change.

One-touch play function

When you play content on a Blu-ray Disc player or “PlayStation®5,” etc. connected to the unit, the unit and TV are turned on automatically.

Hint

- You can change the Control for HDMI settings by selecting [Setup] - [HDMI Settings] - [Control for HDMI] on the home menu.

Related Topic

- [Controlling HDMI devices \(Control for HDMI\)](#)

Multi Channel AV Receiver/Multi Channel AV Amplifier
STR-AN1000/TA-AN1000

Operating the unit by interlocking with a TV compatible with the “BRAVIA” Sync function

“BRAVIA” Sync is an extended function developed by Sony based on the Control for HDMI function. By connecting “BRAVIA” Sync-compatible devices such as a TV or a Blu-ray Disc player using an HDMI cable, you can control the devices by interlocking them with each other.

To use “BRAVIA” Sync

“BRAVIA” Sync is enabled by enabling the Control for HDMI function of the Sony device.

What you can do with “BRAVIA” Sync

Control for HDMI function

- Power interlocking
- Volume adjustment
- Menu Operation by TV Remote Control
- Language Follow
- One-Touch Play Function

Home Theatre Control function

Setting the unit, setting the sound field settings, input switching, etc. can be done without switching the TV input.

Related Topic

- [Operating the unit by Interlocking with a TV \(Control for HDMI function\)](#)

Multi Channel AV Receiver/Multi Channel AV Amplifier
STR-AN1000/TA-AN1000

Switching the TVs that output the HDMI video signals

If [HDMI OUT B Mode] is set to [Main], and you have connected two TVs to the HDMI OUT A (TV) and HDMI OUT B/ZONE 2 jacks, you can switch the output for these two TVs using the HDMI OUT button on the remote control.

1 Connect two TVs to the unit, and turn on the unit and the two TVs.

2 Press HDMI OUT.

Each time you press the button, the output will be switched as follows:

HDMI A - HDMI B - HDMI A+B - HDMI OFF

Note

- [HDMI A+B] may not work if the compatible video formats of the TVs connected to the HDMI OUT A (TV) jack and the HDMI OUT B/ZONE 2 jack of the unit are different.
- [HDMI A+B] may not work depending on the playback device you connect.
- When you connect two Dolby Vision-compatible TVs to the unit and select [HDMI A+B], Dolby Vision content is output in the HDR10 or SDR (Standard Dynamic Range) format. To enjoy Dolby Vision content as it is, connect only one Dolby Vision-compatible TV to the unit, or select either [HDMI A] or [HDMI B].
- If [HDMI OUT B Mode] is set to [Zone2], you cannot select [HDMI B] and [HDMI A+B].
- When [HDMI OUT B Mode] is set to [Zone2], the HDMI signals are output to the Zone 2 even if [HDMI OFF] is selected.

Related Topic

- [Selecting the method to use the HDMI OUT B jack \(HDMI OUT B Mode\)](#)

Multi Channel AV Receiver/Multi Channel AV Amplifier
STR-AN1000/TA-AN1000

Switching between digital and analog audio (Input Mode)

When you connect devices to both digital and analog audio input jacks on the unit, you can fix the audio input mode to either device, or switch from one to the other, depending on the type of material you intend to watch.

1 Select [Setup] - [Input Settings] from the home menu.

2 Select [Assignment].

3 Select [Input Mode].

- **Auto:** Gives priority to digital audio signals. If there is more than one digital connection, HDMI audio signals have priority. If there are no digital audio signals, analog audio signals are selected. When TV input is selected, priority is given to eARC or ARC signals. If your TV does not support the eARC or ARC function, digital optical audio signals are selected.
- **Optical:** Specifies input of digital audio signals to the OPTICAL IN TV jack.
- **Coaxial:** Specifies input of digital audio signals to the COAXIAL IN SA-CD/CD jack.
- **Analog:** Specifies input of analog audio signals to the AUDIO IN (L/R) jacks.

Note

- Depending on the input, [Optical], [Coaxial] or [Analog] may not be displayed.

Multi Channel AV Receiver/Multi Channel AV Amplifier
STR-AN1000/TA-AN1000

Using other digital audio input jacks (Input Assign)

You can reassign the OPTICAL IN TV/COAXIAL IN SA-CD/CD jacks to other input if the default settings of the jacks do not correspond to your connected device.

E.g. When connecting a DVD player to the OPTICAL IN TV jack of the unit, assign the OPTICAL IN TV jack to [BD/DVD].

- 1 Select [Setup] - [Input Settings] from the home menu.
- 2 Select [Assignment].
- 3 Select the input name you want to assign.
- 4 Press ← (left)/→ (right) repeatedly to select [OPTICAL/COAXIAL].
- 5 Press ↑ (up)/↓ (down) repeatedly to select the jack you want to assign.

Assignable digital audio input jacks

OPT:

GAME, MEDIA BOX, BD/DVD, SAT/CATV, VIDEO, AUX, TV (*), SA-CD/CD

COAX :

GAME, MEDIA BOX, BD/DVD, SAT/CATV, VIDEO, AUX, TV, SA-CD/CD (*)

None :

GAME (*), MEDIA BOX (*), BD/DVD (*), SAT/CATV (*), VIDEO (*), AUX (*), TV, SA-CD/CD

* Default setting

Note

- When you assign the digital audio input, the Input Mode setting may change automatically.
- One reassignment is allowed for each input.
- If no sound is output from the assigned jacks, also check the Input Mode settings.

Multi Channel AV Receiver/Multi Channel AV Amplifier
STR-AN1000/TA-AN1000

About Custom Preset

You can save various settings with the player, TV, etc., according to your listening and viewing style. You can register those settings for “one-touch” operation, and then recall the environment created with the settings easily.

For example, by saving the settings in the [Movie] preset as follows, you can switch the settings of the unit all at one time without switching each setting for [Input], [Sound Field] and [Calibration Type] individually.

- Input: BD/DVD
 - Sound Field: Multi Stereo (MULTI ST.)
 - Calibration Type: Engineer
-

Related Topic

- [Saving the settings to a preset](#)

Multi Channel AV Receiver/Multi Channel AV Amplifier
STR-AN1000/TA-AN1000

Saving the settings to a preset

- 1 Select [Custom Preset] from the home menu.
- 2 Press **OPTIONS** with a preset for which you want to edit settings among from [Movie] or [Music] selected.
- 3 Select the menu you want from the options menu.
 - **Edit:** Allows you to customize and save the settings to suit your preferences.
 - **Import:** Loads the present settings of the unit and saves those settings with the preset. [Input] and [Volume] are not stored. If you select [Import], steps 4 and 5 are not required.
- 4 If you selected [Edit] in step 3, press **▲** (up)/**▼** (down) and **⊕** (enter) on the edit screen to select the item you want to set, and then change the setting according to your liking.
- 5 If the check box to the left of the set item is not checked, press **◀** (left)/**▲** (up)/**▼** (down) to select the check box and press **⊕** (enter) to check it.

The setting will be applied.

Note

- Settings for which the box is unchecked are not changed from the present settings even when you recall the preset settings. Select [Edit], then check the box for a setting item on the edit screen.

Hint

- You can overwrite [Movie] with the present settings by holding down CUSTOM1 for 3 seconds in the same way as you do when you select [Import] from the menu.

Related Topic

- [Recalling the preset settings](#)
- [Items for which you can save settings and the default values for each item](#)
- [Available input sources for each zone](#)

Multi Channel AV Receiver/Multi Channel AV Amplifier
STR-AN1000/TA-AN1000

Recalling the preset settings

- 1 Select [Custom Preset] from the home menu.
- 2 Select a preset you want.

Hint

- You can recall the setting(s) saved for [Movie] directly by pressing CUSTOM1 on the remote control.

Related Topic

- [Items for which you can save settings and the default values for each item](#)

Multi Channel AV Receiver/Multi Channel AV Amplifier
STR-AN1000/TA-AN1000

Items for which you can save settings and the default values for each item

“–” for the following items indicates that the check box on the left side of each item is unchecked on the edit screen. Setting items with unchecked boxes are invalid even if values for the items are displayed.

Movie

- Input: BD/DVD
- Tuner Preset: –
- Volume: –
- HDMI Output: –
- Party Mode: –
- Sound Field: Multi Stereo
- 360 Spatial Sound Mapping: –
- In-Ceiling Speaker Mode: –
- Pure Direct: –
- Calibration Type: –
- Front Bass: –
- Front Treble: –
- Center Bass: –
- Center Treble: –
- Surround Bass: –
- Surround Treble: –
- Height Bass: –
- Height Treble: –

Music

- Input: SA-CD/CD
- Tuner Preset: –
- Volume: –
- HDMI Output: –
- Party Mode: –
- Sound Field: Multi Stereo
- 360 Spatial Sound Mapping: –
- In-Ceiling Speaker Mode: –
- Pure Direct: –
- Calibration Type: –
- Front Bass: –
- Front Treble: –
- Center Bass: –
- Center Treble: –
- Surround Bass: –
- Surround Treble: –
- Height Bass: –
- Height Treble: –

Related Topic

- [Saving the settings to a preset](#)

Multi Channel AV Receiver/Multi Channel AV Amplifier
STR-AN1000/TA-AN1000

Saving power during standby mode

You can save power by setting up the unit as follows:

- Set [Audio Return Channel], [Control for HDMI] and [Standby Through] in the [HDMI Settings] menu to [Off].
- Set [Network/Bluetooth Standby] in the [System Settings] menu to [Off].
- Set [Power] of [Zone2] or [Zone3] in the [Zone Controls] menu to [Off].

Note

- If you agree to use the Chromecast built-in function, [Network/Bluetooth Standby] automatically switches to [On].

Related Topic

- [Controlling HDMI devices \(Control for HDMI\)](#)
- [Enjoying content of a connected device without turning on the unit \(Standby Through\)](#)
- [Enjoying sound using speakers in Zone 3](#)





Multi Channel AV Receiver/Multi Channel AV Amplifier
STR-AN1000/TA-AN1000

Performing Easy Setup

You can make the basic settings for using the unit.

1 Select [Setup] - [Easy Setup] from the home menu.

2 Follow the instructions on the TV screen to make the settings.

You can set [Language], [Auto Calibration], [Internet Settings], etc. Press  (up)/ (down)/ (left)/ (right) to select an item, and then press  (enter).

Multi Channel AV Receiver/Multi Channel AV Amplifier
STR-AN1000/TA-AN1000

Changing the name for each input (Name)

You can enter up to 10 characters for each input name.

- 1** Select **[Setup]** - **[Input Settings]** from the home menu.
- 2** Select **[Icon, Name]**.
- 3** Select the input name you want to change in **[Name]**.
An on-screen keyboard appears on the TV screen.
- 4** Press **▲** (up)/**▼** (down)/**◀** (left)/**▶** (right) and **⊕** (enter) to select characters one by one to enter the name.
- 5** Select **[Enter]**.
The name you entered is registered.

Multi Channel AV Receiver/Multi Channel AV Amplifier
STR-AN1000/TA-AN1000

Changing the assignment and display for the input jacks

You can customize the settings for each input according to your preferences and usage. Select [Setup] - [Input Settings] from the home menu, then set each item shown below.

Input

You can change the settings of [Icon], [Name], [Watch / Listen], [Show / Hide], [OPTICAL/COAXIAL], and [Input Mode] for the desired input.

Note

- The settings of [HDMI], [VIDEO IN] and [AUDIO IN] under [Assignment] in [Input Settings] are fixed and cannot be changed.
- The setting of [OPTICAL/COAXIAL] under [Assignment] for [TV] is fixed and cannot be changed.

Hint

- You can also display the [Input Settings] screen by selecting [Edit] from the [Watch] or [Listen] menu.

Icon, Name

Icon

You can set the icon displayed on the Watch / Listen menu.

Name

You can change the name displayed on the Watch / Listen menu.

Watch / Listen

You can set whether an input is displayed on the Watch menu or the Listen menu.

- **Watch:** Displays an input to the Watch menu.
- **Listen:** Displays an input to the Listen menu.
- **Watch / Listen:** Displays an input to both the Watch and Listen menus.

Show / Hide

You can set whether or not an input is displayed.

- **Show:** Shows the input.
- **Hide:** Hides the input.

Assignment

OPTICAL/COAXIAL

You can set the digital audio input jack(s) assigned to each input.

- **OPT1**
- **COAX**
- **None**

Input Mode

You can set the input mode for each input.

- **Auto**
 - **Optical**
 - **Coaxial**
 - **Analog**
-

Related Topic

- [Changing the name for each input \(Name\)](#)
- [Using other digital audio input jacks \(Input Assign\)](#)

5-037-030-11(5) Copyright 2022 Sony Corporation

Multi Channel AV Receiver/Multi Channel AV Amplifier
STR-AN1000/TA-AN1000

Switching between digital and analog audio (Input Mode)

When you connect devices to both digital and analog audio input jacks on the unit, you can fix the audio input mode to either device, or switch from one to the other, depending on the type of material you intend to watch.

1 Select [Setup] - [Input Settings] from the home menu.

2 Select [Assignment].

3 Select [Input Mode].

- **Auto:** Gives priority to digital audio signals. If there is more than one digital connection, HDMI audio signals have priority. If there are no digital audio signals, analog audio signals are selected. When TV input is selected, priority is given to eARC or ARC signals. If your TV does not support the eARC or ARC function, digital optical audio signals are selected.
- **Optical:** Specifies input of digital audio signals to the OPTICAL IN TV jack.
- **Coaxial:** Specifies input of digital audio signals to the COAXIAL IN SA-CD/CD jack.
- **Analog:** Specifies input of analog audio signals to the AUDIO IN (L/R) jacks.

Note

- Depending on the input, [Optical], [Coaxial] or [Analog] may not be displayed.

Multi Channel AV Receiver/Multi Channel AV Amplifier
STR-AN1000/TA-AN1000

Using other digital audio input jacks (Input Assign)

You can reassign the OPTICAL IN TV/COAXIAL IN SA-CD/CD jacks to other input if the default settings of the jacks do not correspond to your connected device.

E.g. When connecting a DVD player to the OPTICAL IN TV jack of the unit, assign the OPTICAL IN TV jack to [BD/DVD].

- 1 Select [Setup] - [Input Settings] from the home menu.
- 2 Select [Assignment].
- 3 Select the input name you want to assign.
- 4 Press ← (left)/→ (right) repeatedly to select [OPTICAL/COAXIAL].
- 5 Press ↑ (up)/↓ (down) repeatedly to select the jack you want to assign.

Assignable digital audio input jacks

OPT:

GAME, MEDIA BOX, BD/DVD, SAT/CATV, VIDEO, AUX, TV (*), SA-CD/CD

COAX :

GAME, MEDIA BOX, BD/DVD, SAT/CATV, VIDEO, AUX, TV, SA-CD/CD (*)

None :

GAME (*), MEDIA BOX (*), BD/DVD (*), SAT/CATV (*), VIDEO (*), AUX (*), TV, SA-CD/CD

* Default setting

Note

- When you assign the digital audio input, the Input Mode setting may change automatically.
- One reassignment is allowed for each input.
- If no sound is output from the assigned jacks, also check the Input Mode settings.

Multi Channel AV Receiver/Multi Channel AV Amplifier
STR-AN1000/TA-AN1000

Switching the speaker configuration (Speaker Configuration Selection)

You can save two speaker configurations as [Preset1] and [Preset2] and switch them. When you change the settings in [Manual Speaker Settings] or [Auto Calibration Settings] under [Speaker Settings], the changes are reflected in the current speaker configuration ([Preset1] or [Preset2]) and saved.

- 1 Select [Setup] - [Speaker Settings] from the home menu.
- 2 Select [Speaker Configuration Selection].
- 3 Select a saved speaker configuration with your favorite settings.
 - Preset1
 - Preset2

Multi Channel AV Receiver/Multi Channel AV Amplifier
STR-AN1000/TA-AN1000

Checking saved speaker configuration information (Speaker Configuration Information)

You can check the information saved in the preset selected in [Speaker Configuration Selection].

- 1 Select [Setup] - [Speaker Settings] from the home menu.
- 2 Select [Speaker Configuration Information].
- 3 Select the speaker configuration you want to check.
 - Preset1
 - Preset2

Multi Channel AV Receiver/Multi Channel AV Amplifier
STR-AN1000/TA-AN1000

Performing Auto Calibration (Auto Calibration Settings)

You can perform Auto Calibration from your listening position.

- 1 Select [Setup] - [Speaker Settings] from the home menu.
- 2 Select [Auto Calibration Settings].
- 3 Select [Auto Calibration], and then select [Start].
- 4 Follow the instructions on the TV screen to check the connection of external devices, set the speaker configuration, and perform automatic measurement using the measurement microphone and microphone stand.
Auto Calibration is performed twice.
- 5 When the measurement is complete, select the item you want.
 - **Save:** Saves the measurement results and exits the setting process.
 - **Retry:** Performs the Auto Calibration again.
 - **Discard:** Exits the setting process without saving the measurement results.
- 6 Save the measurement results.
Select [Save] in step 5.

Note

- If the measurement fails, follow the message, then select [Retry]. For details on the error code and warning message, see "[List of messages after Auto Calibration measurements.](#)"
- This setting is not available when headphones are connected.

Hint

- The Auto Calibration measurement will be canceled if you perform the following during the measurement process:
 - Press \odot (power).
 - Press the input buttons on the remote control or turn INPUT SELECTOR on the unit.
 - Press HOME, AMP MENU, HDMI OUT or \times (muting) on the remote control.
 - Press SPEAKERS on the unit.
 - Change the volume level.
 - Connect headphones.
 - Press MUSIC on the remote control or the unit.

Multi Channel AV Receiver/Multi Channel AV Amplifier
STR-AN1000/TA-AN1000

Calibrating the phase characteristics of the speakers (Automatic Phase Matching)

You can set the A.P.M. (Automatic Phase Matching) function in the D.C.A.C. IX (Digital Cinema Auto Calibration). This calibrates the phase characteristics of the speakers for well-coordinated surround sound.

- 1 Select **[Setup] - [Speaker Settings]** from the home menu.
- 2 Select **[Auto Calibration Settings]**.
- 3 Select **[Automatic Phase Matching]**.
- 4 Select the setting you want.
 - **Auto:** Switches the [Automatic Phase Matching] function on or off automatically.
 - **Off**

Note

- This function does not work in the following cases:
 - Headphones are connected.
 - [Auto Calibration] has not been performed.
 - [Bluetooth Mode] is set to [Transmitter].
 - [DSD Native] is set to [On] and DSD signals are being played back.
 - [Pure Direct] is set to [On].
- The unit may play signals at a lower sampling frequency than the actual sampling frequency of the input signals, depending on the audio format.

Multi Channel AV Receiver/Multi Channel AV Amplifier
STR-AN1000/TA-AN1000

Selecting the Auto Calibration type (Calibration Type)

You can select a calibration type after you have performed the Auto Calibration and saved the settings.

- 1 Select [Setup] - [Speaker Settings] from the home menu.
- 2 Select [Auto Calibration Settings].
- 3 Select [Calibration Type].
- 4 Select the setting you want.
 - **Full Flat:** Makes the measurement of frequency from each speaker flat.
 - **Engineer:** Sets to “the Sony listening room standard” frequency characteristics.
 - **Front Reference:** Adjusts the characteristics of all of the speakers to match the characteristics of the front speaker.
 - **Off**

Note

- This function does not work in the following cases:
 - Headphones are connected.
 - [Auto Calibration] has not been performed.
 - [Bluetooth Mode] is set to [Transmitter].
 - [DSD Native] is set to [On] and DSD signals are being played back.
 - [Pure Direct] is set to [On].
- The unit may play signals at a lower sampling frequency than the actual sampling frequency of the input signals, depending on the audio format.

Multi Channel AV Receiver/Multi Channel AV Amplifier
STR-AN1000/TA-AN1000

Selecting a wireless speaker connection mode (Link mode)

This unit supports connection with an optional Sony wireless rear speaker/subwoofer.
You can set the connection method for the wireless rear speaker/subwoofer.

- 1 Select **[Setup]** - **[Speaker Settings]** from the home menu.
- 2 Select **[Wireless Speaker Settings]**.
- 3 Select **[Link mode]**.
- 4 Select the connection method.
 - **Auto:** Connects the wireless rear speaker/subwoofer automatically.
 - **Manual:** Connects the wireless rear speaker/subwoofer manually.

Multi Channel AV Receiver/Multi Channel AV Amplifier
STR-AN1000/TA-AN1000

Connecting wireless speakers manually (Start manual linking)

The unit is compatible with connection to Sony wireless rear speaker/subwoofer (not supplied).

When you connect the Sony wireless rear speaker/subwoofer to the unit for the first time, follow the steps below.

Once connected, the Sony wireless rear speaker/subwoofer will be automatically connected to the unit the next time you turn on the power.

1 Select [Setup] - [Speaker Settings] from the home menu.

2 Select [Wireless Speaker Settings].

3 Select [Start manual linking].

4 Press LINK on the speaker (not supplied).

The power indicator of the speaker (not supplied) that had LINK pressed flashes twice repeatedly in green.

5 Select [Start].

The manual connection starts. The connecting process appears on the TV screen. To cancel the manual connection, select [Cancel].

6 When [Connected] is displayed for the target speakers, select [Finish].

7 Press  (enter).

The manual connection is established and the power indicator of the speaker (not supplied) lights in green.

8 Follow the on-screen instructions to perform Auto Calibration.

When the connection settings of wireless speakers are complete, a screen that guides you to [Auto Calibration] is displayed.

When you connect a wireless rear speaker, select either [Surround] or [Surround Back] on the [- Wireless Speaker Assign] screen in Auto Calibration to assign the speaker position.

Hint

- For the wireless rear speaker/subwoofer models compatible with the unit, visit the Sony website.
- If you connect 2 wireless subwoofers, use the same model.
- For details on the wireless rear speaker/subwoofer, refer to the operating instructions supplied with each speaker.

Multi Channel AV Receiver/Multi Channel AV Amplifier
STR-AN1000/TA-AN1000

Checking the connection status of wireless speakers (Check wireless connection)

You can check the connection status of the wireless rear speaker/subwoofer.

- 1 Select **[Setup]** - **[Speaker Settings]** from the home menu.
- 2 Select **[Wireless Speaker Settings]**.
- 3 Select **[Check wireless connection]**.

Multi Channel AV Receiver/Multi Channel AV Amplifier
STR-AN1000/TA-AN1000

Setting to the optimum frequency for wireless speaker connection (RF Channel)

By setting the frequency to be optimal for connecting a wireless speaker, you can suppress sound interruption.

- 1 Select [Setup] - [Speaker Settings] from the home menu.
- 2 Select [Wireless Speaker Settings].
- 3 Select [RF Channel].
- 4 Select the setting.
 - **On:** The optimum frequency is automatically selected. This is the stronger mode for wireless interference.
 - **Off:** The frequency band is fixed to avoid interference during wireless connection. If sound dropping occurs while [On] is selected, it may be improved by selecting [Off].

Hint

- If you want to optimize the frequency immediately, switch this function to [Off], and then [On].

Multi Channel AV Receiver/Multi Channel AV Amplifier
STR-AN1000/TA-AN1000

Selecting the playback quality of the wireless speaker (Wireless Playback Quality)

You can select the playback quality of the wireless speaker.

- 1 Select **[Setup]** - **[Speaker Settings]** from the home menu.
- 2 Select **[Wireless Speaker Settings]**.
- 3 Select **[Wireless Playback Quality]**.
- 4 Select **[Sound Quality]** or **[Connection]**.

Multi Channel AV Receiver/Multi Channel AV Amplifier
STR-AN1000/TA-AN1000

Checking the software version of the wireless speakers (Software Version)

You can check the software version of the wireless speakers.

- 1 Select [Setup] - [Speaker Settings] from the home menu.
- 2 Select [Wireless Speaker Settings].
- 3 Select [Software Version].

Multi Channel AV Receiver/Multi Channel AV Amplifier
STR-AN1000/TA-AN1000

Outputting the center speaker part of the sound from the TV speakers (TV Center Speaker Mode)

If your TV has an S-center speaker input jack, you can use the TV screen as a center speaker by connecting the TV to the S-CENTER OUT jack of this unit.

- 1 Select [Setup] - [Speaker Settings] from the home menu.
- 2 Select [TV/Screen Center Settings].
- 3 Select [TV Center Speaker Mode].
- 4 Select [On].

Note

- This function does not work in the following cases:
 - Headphones are connected.
 - [Speaker Pattern] is set to a setting without center speaker.
 - [Bluetooth Mode] is set to [Transmitter].

Multi Channel AV Receiver/Multi Channel AV Amplifier
STR-AN1000/TA-AN1000

Lifting up the sound of the center speaker (Center Speaker Lift Up)

By using the front high speakers, you can lift up the sounds of the center speaker to an appropriate height on the screen, allowing you to enjoy natural sound without discomfort.

- 1 Select **[Setup]** - **[Speaker Settings]** from the home menu.
- 2 Select **[TV/Screen Center Settings]**.
- 3 Select **[Center Speaker Lift Up]**.
- 4 Select the setting you want.
 - 1 - 10
 - Off

Hint

- This function does not work in the following cases:
 - Headphones are connected.
 - There is no center speaker.
 - [Height/Overhead Speakers] is set to other than [FH] (Front High Speaker) in [Speaker Pattern] setting.
 - The [2ch Stereo] or [Multi Stereo] sound field is being used.
 - A sound field for music is being used.
 - [Bluetooth Mode] is set to [Transmitter].
 - [In-Ceiling Speaker Mode] is set to [Front & Center] or [Front].
 - [DSD Native] is set to [On] and DSD signals are being played back.

Multi Channel AV Receiver/Multi Channel AV Amplifier
STR-AN1000/TA-AN1000

Enjoying more natural sound with speakers installed in the ceiling (In-Ceiling Speaker Mode)

Set whether or not to use [In-Ceiling Speaker Mode] with the current input.

In a setup where the front and center speakers are installed in the ceiling, lowering the audio output position to the screen height allows you to enjoy a more natural experience.

- 1 Select [Sound Effects] - [In-Ceiling Speaker Mode] from the home menu.
- 2 Select the setting you want.
 - **Front & Center:** Lowers the audio output position for both the front and center speakers installed in ceiling to the screen height.
 - **Front:** Lowers the audio output position for the front speakers installed in ceiling to the screen height.
 - **Off:** Does not activate this function.

Note

- This function does not work in the following cases:
 - Headphones are connected.
 - [Bluetooth Mode] is set to [Transmitter].
 - [Pure Direct] is set to [On].
 - [DSD Native] is set to [On] and DSD signals are being played back.
- This function does not work if you select a sound field other than the following:
 - 2ch Stereo
 - Multi Stereo
- This function may not work depending on the audio format.
- The unit may play signals at a lower sampling frequency than the actual sampling frequency of the input signals depending on the audio format.

Hint

- You can also select [In-Ceiling Speaker Mode] from [Speaker Settings] - [TV/Screen Center Settings] in the [Setup] menu.
- To obtain optimal effects in the listening environment, set [Manual Speaker Settings] - [Height] - [Ceiling] from [Speaker Settings] menu and perform Auto Calibration.

Outputting a test tone from each speaker (Test Tone)

You can output a test tone from each speaker in sequence.

1 Select [Setup] - [Speaker Settings] from the home menu.

2 Select [Manual Speaker Settings].

3 Select [Test Tone].

The same operation can also be performed by pressing TEST on the remote control.

4 Select the setting you want.

- Off
- **Auto:** The test tone is output from each speaker in sequence.
- **Front (L), Center, TV Center, Front (R), Surround (L), Surround (R), Surround Back (L), Surround Back (R), Height (L), Height (R), Subwoofer:** You can select which speakers will output the test tone.

5 Adjust the speaker level.

Note

- When [Bluetooth Mode] is set to [Transmitter], this function does not work.

Hint

- To adjust the level of all speakers at the same time, press \triangleleft (volume) +/- . You can also use MASTER VOLUME on the unit.
- The adjusted value is shown on the TV screen during adjustment.

Multi Channel AV Receiver/Multi Channel AV Amplifier
STR-AN1000/TA-AN1000

Adjusting the speaker level (Level)

You can adjust the output level of each speaker.

- 1 Select [Setup] - [Speaker Settings] from the home menu.
- 2 Select [Manual Speaker Settings].
- 3 Select [Level].
- 4 Select the speaker whose level you want to adjust from the following.
 - Front (L), Center, TV Center (*), Front (R), Surround (L), Surround (R), Surround Back (L), Surround Back (R), Subwoofer

* [TV Center] is displayed when the configuration including TV Center (S-Center) is selected in the [Speaker Pattern] setting.
- 5 Adjust the level.

Note

- When [Bluetooth Mode] is set to [Transmitter], [Level] cannot be set.
- If headphones are connected, you can only adjust the level of [Front (L)] and [Front (R)].

Multi Channel AV Receiver/Multi Channel AV Amplifier
STR-AN1000/TA-AN1000

Adjusting the equalizer (Equalizer)

You can use the following parameters to adjust the tonal quality (bass/treble level) of each speaker.

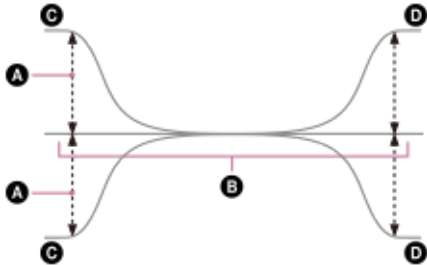

- A** Level (dB)
- B** Frequency (Hz)
- C** Bass
- D** Treble

- 1** Select [Sound Effects] - [Equalizer] from the home menu.
- 2** Select [Front], [Center], [Surround] or [Height].
- 3** Select [Bass] or [Treble].
- 4** Adjust the gain.

Note

- This function does not work in the following cases:
 - [Pure Direct] is set to [On].
 - [Bluetooth Mode] is set to [Transmitter].
 - [DSD Native] is set to [On], and the unit is playing audio signals in DSD format.
- Frequencies for [Bass] and [Treble] are fixed.
- Depending on the audio format, the unit may play signals at a lower sampling frequency than the original sampling frequency of the input signals.
- Only [Bass] gain and [Treble] gain are available for [Front] when headphones are connected.

Hint

- You can also select [Equalizer] in [Setup] - [Speaker Settings] - [Manual Speaker Settings] from the home menu.

Multi Channel AV Receiver/Multi Channel AV Amplifier
STR-AN1000/TA-AN1000

Setting the distance from the listening position to the screen and each speaker (Distance from Listening Position)

You can adjust the distance from the listening position to the screen and each speaker.

1 Select [Setup] - [Speaker Settings] from the home menu.

2 Select [Manual Speaker Settings].

3 Select [Distance from Listening Position].

4 Select the screen and speakers you want to adjust.

Screen, Front (L), Center, Front (R), Surround (R), Surround (L), Surround Back (L), Surround Back (R), Subwoofer

5 Adjust the distance.

Note

- Some parameters may not be available depending on the speaker pattern setting.
- This function cannot be set in the following cases:
 - Headphones are connected.
 - [Bluetooth Mode] is set to [Transmitter].

Multi Channel AV Receiver/Multi Channel AV Amplifier
STR-AN1000/TA-AN1000

Setting the distance between the screen and each speaker (Distance from the Screen)

You can adjust the distance between the screen and each speaker.

- 1 Select [Setup] - [Speaker Settings] from the home menu.
- 2 Select [Manual Speaker Settings].
- 3 Select [Distance from the Screen].
- 4 Select the speakers you want to adjust.
Front (L), Center, Front (R), Surround (R), Surround (L), Surround Back (L), Surround Back (R), Height (L), Height (R)
- 5 Adjust the distance.

Note

- Some parameters may not be available depending on the speaker pattern setting.
- This function cannot be set in the following cases:
 - Headphones are connected.
 - [Bluetooth Mode] is set to [Transmitter].

Multi Channel AV Receiver/Multi Channel AV Amplifier
STR-AN1000/TA-AN1000

Setting the height of the screen, listening position, and each speakers (Height)

Set the height from the floor to the screen, listening position, and each speaker. You can make the [In-Ceiling Speaker Mode] function and Dolby Atmos enabled speakers work better by configuring this setting and performing Auto Calibration.

1 Select [Setup] - [Speaker Settings] from the home menu.

2 Select [Manual Speaker Settings].

3 Select [Height].

4 Select the items you want to adjust.

Screen, Listening position, Ceiling, Front (L), Center, Front (R), Surround (R), Surround (L), Surround Back (L), Surround Back (R), Height (L), Height (R), Subwoofer

5 Adjust the height.

Note

- This function cannot be set in the following cases:
 - Headphones are connected.
 - [Bluetooth Mode] is set to [Transmitter].

Multi Channel AV Receiver/Multi Channel AV Amplifier
STR-AN1000/TA-AN1000

Adjusting the speaker size (Size)

You can adjust the size of each speaker.

- 1 Select [Setup] - [Speaker Settings] from the home menu.
- 2 Select [Manual Speaker Settings].
- 3 Select [Size].
- 4 Select the speaker whose size you want to adjust from the following.
Front, Center, Surround, Height
- 5 Select the size you want.
 - **Large:** If you connect large speakers that will effectively reproduce bass frequencies, select [Large]. Select [Large] usually.
 - **Small:** If the sound is distorted, or you hear a lack of surround effects when using multi channel surround sound, select [Small]. You can activate the bass redirection circuitry and output the bass frequencies of each channel from the subwoofer or other [Large] speakers.

Note

- [Size] cannot be set in the following cases:
 - Headphones are connected.
 - [Bluetooth Mode] is set to [Transmitter].
 - [Speaker Pattern] is set to [2.0].

Hint

- The surround back speakers will be set to the same setting as that of the surround speakers.
- When the front speakers are set to [Small], the center, surround and height speakers are also automatically set to [Small].
- If you do not use the subwoofer, the front speakers are automatically set to [Large].

Multi Channel AV Receiver/Multi Channel AV Amplifier
STR-AN1000/TA-AN1000

Setting the crossover frequency of the speakers (Crossover Frequency)

You can set the bass crossover frequency of speakers for which [Manual Speaker Settings] - [Size] has been set to [Small] in the [Speaker Settings] menu. A measured speaker crossover frequency is set for each speaker after the Auto Calibration is performed.

- 1 Select [Setup] - [Speaker Settings] from the home menu.
- 2 Select [Manual Speaker Settings].
- 3 Select [Crossover Frequency].
- 4 Select the speaker for which you want to adjust the crossover frequency on the screen.
- 5 Set the crossover frequency of the selected speaker.

Note

- This function does not work in the following cases:
 - Headphones are connected.
 - [Bluetooth Mode] is set to [Transmitter].
 - [Size] for none of the speakers is set to [Small].
- The surround back speakers will be set to the same setting as that of the surround speakers.

Multi Channel AV Receiver/Multi Channel AV Amplifier
STR-AN1000/TA-AN1000

Assigning wireless speakers (Wireless Speaker Assign)

If you use wireless speakers, you can set the wireless speaker assignment.

1 Select [Setup] - [Speaker Settings] from the home menu.

2 Select [Manual Speaker Settings].

3 Select [Wireless Speaker Assign].

4 Select the item you want to assign.

Surround Back, Surround Back + SW, Surround, Surround + SW, SW (Subwoofer)

Note

- You can only set [Wireless Speaker Assign] under the following conditions:
 - [Speaker Pattern] is set to a setting including the surround speaker or surround back speaker.
 - The subwoofer is set in [Speaker Pattern].
 - Headphones are not connected.
 - [Bluetooth Mode] is set to other than [Transmitter].

Related Topic

- [Selecting the speaker pattern \(Speaker Pattern\)](#)

Multi Channel AV Receiver/Multi Channel AV Amplifier
STR-AN1000/TA-AN1000

Assigning the surround back speaker terminals (Surround Back Speaker Assign)

You can set the assignment for the SPEAKERS SURROUND BACK/HEIGHT (FRONT B/BI-AMP/ZONE 3) terminals.

1 Select [Setup] - [Speaker Settings] from the home menu.

2 Select [Manual Speaker Settings].

3 Select [Surround Back Speaker Assign].

4 Select the setting you want.

- **Zone3:** When using the Zone 3 connection.
- **BI-AMP:** When using the bi-amplifier speaker connection.
- **Front B:** When using the front B speaker connection.
- **Off:** When none of the above connections is used.

Note

- You can only set [Surround Back Speaker Assign] under the following conditions:
 - The speaker pattern is set to a setting without surround back and height speakers.
 - Headphones are not connected.
 - [Bluetooth Mode] is set to other than [Transmitter].

Related Topic

- [Connecting 5.1-channel speaker system with bi-amplifier connection](#)
- [Connecting 5.1-channel speaker system with front B speaker connection](#)
- [Connecting 5.1-channel speaker system with Zone 3 connection](#)
- [Selecting the speaker pattern \(Speaker Pattern\)](#)
- [Selecting the front speakers](#)

Multi Channel AV Receiver/Multi Channel AV Amplifier
STR-AN1000/TA-AN1000

Selecting the speaker pattern (Speaker Pattern)

You can select the speaker pattern according to the speaker system which you are using.

- 1 Select [Setup] - [Speaker Settings] from the home menu.
- 2 Select [Manual Speaker Settings].
- 3 Select [Speaker Pattern].
- 4 Select the speaker pattern appropriate to your speaker configuration under [Listener-level Speakers] by referring to the speaker installation example displayed on the TV screen.
- 5 Select the height/overhead speaker appropriate to your speaker configuration under [Height/Overhead Speakers] by referring to the speaker installation example displayed on the TV screen.
- 6 Select [Save].

Note

- This function does not work in the following cases:
 - Headphones are connected.
 - [Bluetooth Mode] is set to [Transmitter].
- If a speaker pattern with surround back speakers is selected, you cannot set [Height/Overhead Speakers].

Related Topic

- [Speaker configuration and speaker pattern settings](#)

Multi Channel AV Receiver/Multi Channel AV Amplifier
STR-AN1000/TA-AN1000

Checking the speaker position and the corresponding speaker terminals (Speaker Connection Guide)

This function lets you know the position of the speaker you select and the corresponding speaker terminals on the unit to which the speaker should be connected.

- 1 Select [Setup] - [Speaker Settings] from the home menu.
- 2 Select [Manual Speaker Settings].
- 3 Select [Speaker Connection Guide].
- 4 Select the speaker you want from the list on the right side of the screen

The position of the speaker and the corresponding terminals on the unit to which the speaker should be connected are shown on the screen.

Note

- When connecting speaker cables, etc., be sure to disconnect the AC power cord (mains lead).

Multi Channel AV Receiver/Multi Channel AV Amplifier
STR-AN1000/TA-AN1000

Selecting the unit of measurement (Distance Unit)

You can select the unit of measurement for setting distances.

- 1 Select [Setup] - [Speaker Settings] from the home menu.
- 2 Select [Manual Speaker Settings].
- 3 Select [Distance Unit].
- 4 Select the setting you want.
 - **meter:** The distance is displayed in meters.
 - **feet:** The distance is displayed in feet.

Multi Channel AV Receiver/Multi Channel AV Amplifier
STR-AN1000/TA-AN1000

Setting up a wired LAN connection

You can set up a wired LAN connection by the following procedure. Connect the unit and the router with a LAN cable beforehand.

- 1 Select **[Setup]** - **[Network Settings]** from the home menu.
- 2 Select **[Internet Settings]**.
- 3 Select **[Next]** when **[LAN cable connection was detected. Perform Wired LAN setup.]** appears.
- 4 Select **[Auto]** on the TV screen for the IP address acquisition method.
To set the IP address manually, select **[Manual]** and follow the on-screen instructions.
The network settings are displayed on the TV screen.
- 5 Press **➡** (right).
- 6 Select **[Save & Connect]**.
The unit starts connecting to the network.
When the unit is successfully connected to the network, **[NETWORK]** lights up on the display panel of the unit.

Hint

- See **[Network Connection Status]** in the **[Network Settings]** menu when checking the network settings.

Related Topic

- [Connecting a LAN cable \(for wired LAN connections only\)](#)

Multi Channel AV Receiver/Multi Channel AV Amplifier
STR-AN1000/TA-AN1000

Setting up a wireless LAN connection

Please confirm the following information before starting the network settings.

- The network name (SSID) (*1) of the wireless LAN router/access point
- The security key (passkey) (*2) for the network

*1 SSID (Service Set Identifier) is a name that identifies a particular access point.

*2 This information should be available from a label on your wireless LAN router/access point, from the operating instructions, from the person who set up your wireless network, or from the information provided by your Internet service provider.

1 Select [Setup] - [Network Settings] from the home menu.

2 Select [Internet Settings].

3 Select [Next] when [Perform Wi-Fi setup.] is displayed on the TV screen.

A list of network names (SSID) is displayed on the TV screen.

4 Select a network name (SSID).

The unit starts connecting to the network.

To connect to a network not listed, select [New connection registration] and follow the on-screen instructions.

5 Confirm the connection result displayed on the TV screen.

When the unit is successfully connected to the network, [NETWORK] lights up on the display panel of the unit.

If the connection to the network has failed, select [Advanced Settings], and then follow the on-screen instructions to set the network name (SSID), wireless LAN router security method, and IP address.

Hint

- See [Network Connection Status] in the [Network Settings] menu when checking the network settings.

Related Topic

- [Connecting the unit to the network using the wireless LAN antenna \(for wireless LAN connections only\)](#)

Multi Channel AV Receiver/Multi Channel AV Amplifier
STR-AN1000/TA-AN1000

Checking the network connection status (Network Connection Status)

You can check the various settings on the network.

- 1 Select [Setup] - [Network Settings] from the home menu.
- 2 Select [Network Connection Status].

Multi Channel AV Receiver/Multi Channel AV Amplifier
STR-AN1000/TA-AN1000

Receiving information on newer software (Software Update Notification)

You can set whether or not to be informed of newer software version information of the unit on the TV screen.

- 1 Select [Setup] - [Network Settings] from the home menu.
- 2 Select [Software Update Notification].
- 3 Select [On] or [Off].

Note

- New software version information does not appear in the following cases:
 - The latest version is already being used.
 - The unit cannot obtain data via a network.

Multi Channel AV Receiver/Multi Channel AV Amplifier
STR-AN1000/TA-AN1000

Updating the software automatically (Auto Update Settings)

You can set the software to update automatically. If you set [Auto Update] to [On], the auto update is performed from 2:00 AM to 5:00 AM of the selected time zone.

- 1 Select [Setup] - [Network Settings] from the home menu.
- 2 Select [Auto Update Settings].
- 3 Select [Auto Update] and set to [On].
- 4 Confirm [Time Zone] is selected and then press .
- 5 Select the area and then select the nearest city to where you live.

Note

- To update the software at the midnight while the unit is not used, set [Auto Update] and [Network/Bluetooth Standby] to [On].
- If [Auto Update] is set to [On] while [Network/Bluetooth Standby] is set to [Off], update starts automatically while the unit is turned off.
- Depending on the provided update type, the update may start automatically even if [Auto Update] is set to [Off], or the update may start automatically while the unit is turned off.

Multi Channel AV Receiver/Multi Channel AV Amplifier
STR-AN1000/TA-AN1000

Setting acceptance or rejection of information collection (Privacy Setting)

This unit is equipped with the function to collect the usage conditions of the device. Check the privacy policy displayed at the time of setting and set whether to accept or reject the information collection.

- 1 Select **[Setup]** - **[Network Settings]** from the home menu.
- 2 Select **[Privacy Setting]**.
- 3 Select the setting.
 - **Agree**: Select this if you agree to the collection of information on the usage condition of the device.
 - **Do not agree**: Select this if you disagree to the collection of information on the usage condition of the device.
- 4 Select **[Complete]**.

Hint

- Even if you select **[Agree]**, you can stop the collection of information by reselecting **[Do not agree]** or resetting **[Network Settings]** to the default settings in **[Resetting]**.

Multi Channel AV Receiver/Multi Channel AV Amplifier
STR-AN1000/TA-AN1000

Checking information for Chromecast built-in function (Chromecast built-in)

You can modify the settings or check information about the Chromecast built-in function.

- 1 Select [Setup] - [Network Settings] from the home menu.
- 2 Select [Chromecast built-in].
- 3 Check the following items.
 - **Share usage data:** When set to [On], the usage condition data is collected.
 - **About Chromecast built-in:** Shows references about Chromecast built-in function.

Multi Channel AV Receiver/Multi Channel AV Amplifier
STR-AN1000/TA-AN1000

Setting to use the unit by connecting to a Sonos device (Works with Sonos)

- 1 Select [Setup] - [Network Settings] from the home menu.
- 2 Select [Works with Sonos].
- 3 Select the Sonos device you want to connect from the list on the right side of the TV screen.
If there is no connected device in the list, select [Refresh].

To disconnect a connected Sonos device

Select [Remove Connected Device].

To set a connected Sonos device

After step 2, you can make the following settings for each connected device.

- **Input:** Selects an input that works with your Sonos device.
- **Preset Volume:** Sets the volume when selecting an input of the Sonos device.
- **Output Zone:** Sets the zone to which the sound of the Sonos device is output.

Multi Channel AV Receiver/Multi Channel AV Amplifier
STR-AN1000/TA-AN1000

Upscaling video signals to 4K/8K (4K/8K Upscaling)

You can up-convert video signals to 4K/8K and output them through the HDMI OUT jack of the unit.

- 1 Select **[Setup]** - **[HDMI Settings]** from the home menu.
- 2 Select **[4K/8K Upscaling]**.
- 3 Select the setting you want.
 - **Auto**: Enables video scaling control of 4K/8K HDMI output automatically if you connect a 4K/8K-compatible TV.
 - **Off**

Note

- This function works only when video signals from HDMI IN jacks are being received. HDMI video input signals must be 1920x1080p 24/50/60 Hz 2D or 3840x2160p 24/50/60 Hz.
- When **[HDMI OUT B Mode]** is set to **[Zone2]**, the HDMI OUT B/ZONE 2 jack does not support **[4K/8K Upscaling]**.
- This function does not work when the input signal is a compressed video signal, VRR signal or Dolby Vision signal.

Multi Channel AV Receiver/Multi Channel AV Amplifier
STR-AN1000/TA-AN1000

Controlling HDMI devices (Control for HDMI)

You can turn the Control for HDMI function on or off.

- 1 Select [Setup] - [HDMI Settings] from the home menu.
- 2 Select [Control for HDMI].
- 3 Select the setting you want.
 - **On:** Can be operated in conjunction with devices connected with an HDMI cable.
 - **Off**

Note

- When the unit is in standby mode, the  (power) indicator on the front panel lights up in amber if [Control for HDMI] is set to [On].
- This function is enabled only when [HDMI OUT B Mode] is set to [Main].

Related Topic

- [Operating the unit by Interlocking with a TV \(Control for HDMI function\)](#)

Multi Channel AV Receiver/Multi Channel AV Amplifier
STR-AN1000/TA-AN1000

Turning off the unit and connected devices simultaneously with the TV (System Power Off function) (Standby Linked to TV)

You can turn off the unit and the connected device automatically when you turn off the TV.

- 1 Select [Setup] - [HDMI Settings] from the home menu.
- 2 Select [Standby Linked to TV].
- 3 Select the setting you want.
 - **Auto:** When the input of this unit is [GAME], [MEDIA BOX], [BD/DVD], [SAT/CATV], [VIDEO], [TV] or [SA-CD/CD], the unit will turn off when the TV is turned off.
 - **On:** The unit will turn off when the TV is turned off regardless of the input of the unit.
 - **Off:** The power of the unit does not turn off when the TV is turned off, regardless of the input of the unit.

Note

- You can set this function only when [HDMI OUT B Mode] is set to [Main] and [Control for HDMI] is set to [On].
- The connected device may not turn off depending on the status of the device.
- System Power Off function may work with devices other than those manufactured by Sony, but operation is not guaranteed.

Multi Channel AV Receiver/Multi Channel AV Amplifier
STR-AN1000/TA-AN1000

Enjoying content of a connected device without turning on the unit (Standby Through)

This function allows you to enjoy the sound and image of a connected device without turning on the unit.

1 Select [Setup] - [HDMI Settings] from the home menu.

2 Select [Standby Through].

3 Select the setting you want.

- **Auto:** The unit outputs HDMI signals to the TV from the HDMI OUT A (TV) jack when the TV is turned on while the unit is in the standby mode.
Sony recommends this setting if you are using a "BRAVIA" Sync-compatible TV manufactured by Sony. This setting saves power in the standby mode compared to the [On] setting.
- **On:** The unit continuously outputs HDMI signals from the HDMI OUT A (TV) jack when in standby mode. Sony recommends this setting if you are using a TV that is not manufactured by Sony.
- **Off:** The unit does not output HDMI signals when in standby mode. This setting saves power in the standby mode compared to the [On] setting.

Note

- When the unit is in standby mode, the  (power) indicator on the front panel lights up in amber if [Standby Through] is set to [On] or [Auto].
- When [Auto] is selected, it may take a little more time for the image and sound to be output to the TV than when [On] is selected.
- This function does not work for the HDMI OUT B/ZONE 2 jack.
- [Auto] may work on other devices than those manufactured by Sony. However, operation is not guaranteed.

Multi Channel AV Receiver/Multi Channel AV Amplifier
STR-AN1000/TA-AN1000

Enabling the eARC/ARC function (Audio Return Channel)

Set this function when a TV that supports the eARC/ARC function is connected to the unit.

- 1 Select **[Setup]** - **[HDMI Settings]** from the home menu.
- 2 Select **[Audio Return Channel]**.
- 3 Select the setting you want.
 - **eARC**: When the unit is connected to a TV that supports the eARC function, the eARC function works. When the unit is connected to a TV that supports the ARC function (not compatible with the eARC function), the ARC function works.
 - **ARC**: When the unit is connected to a TV that supports the eARC/ARC function, the ARC function works. The eARC function is disabled.
 - **Off**: The eARC/ARC function is disabled.

Note

- This function can be set only when the **[Input Mode]** of the TV input is set to **[Auto]**.
- Depending on your TV, eARC setting items may be available. If you set **[Audio Return Channel]** to **[eARC]** on the unit, also check the settings on the TV. For details, refer to the instruction manual of the TV.

Related Topic

- [Setting TV audio output \(when using the eARC/ARC function\)](#)
- [Digital audio formats supported by the unit](#)

Multi Channel AV Receiver/Multi Channel AV Amplifier
STR-AN1000/TA-AN1000

Setting the HDMI audio signal output of connected devices (Audio Out)

You can set the HDMI audio signal output of playback devices connected to the unit via an HDMI connection.

- 1 Select **[Setup]** - **[HDMI Settings]** from the home menu.
- 2 Select **[Audio Out]**.
- 3 Select the setting you want.
 - **AMP**: HDMI audio signals from playback devices are only output to the speakers connected to the unit. Multi-channel sound can be played back as it is.
 - **TV + AMP**: The sound is output from the speaker of the TV and the speakers connected to the unit.

Note

- This function cannot be set in the following cases:
 - **[Control for HDMI]** is set to **[On]**.
 - **[Audio Return Channel]** is set to **[eARC]** or **[ARC]**.
- Audio signals are not output from the speaker of the TV when **[Audio Out]** is set to **[AMP]**.
- When **[TV + AMP]** is selected, the sound quality of the playback device depends on the sound quality of the TV, such as the number of channels and the sampling frequency, etc. If the TV has stereo speakers, the sound output from the unit is in the same stereo as the TV, even when playing back multi-channel source.
- When you connect the unit to a video device (projector, etc.), sound may not be output from the unit. In this case, select **[AMP]**.
- When you select **[TV + AMP]**, only sound from the HDMI IN jacks is output from the speaker of the TV.

Multi Channel AV Receiver/Multi Channel AV Amplifier
STR-AN1000/TA-AN1000

Setting the level of the subwoofer (Subwoofer Level)

You can adjust the level of the subwoofer by 0 dB or +10 dB with respect to the input signal when multi-channel PCM signals are input via an HDMI connection. The level for each input to which an HDMI jack is assigned can be set independently.

1 Select [Setup] - [HDMI Settings] from the home menu.

2 Select [Subwoofer Level].

3 Select the setting you want.

- **Auto:** Automatically sets the level adjustment to 0 dB or +10 dB, depending on the audio stream.
- **+10 dB:** Adjusts the level by +10 dB with respect to the input signal.
- **0 dB:** Does not adjust the level with respect to the input signal.

Note

- When [GAME], [MEDIA BOX], [BD/DVD], [SAT/CATV], [VIDEO], or [SA-CD/CD] is selected as the input, each input can be set independently.

Multi Channel AV Receiver/Multi Channel AV Amplifier
STR-AN1000/TA-AN1000

Selecting the method to use the HDMI OUT B jack (HDMI OUT B Mode)

You can use the HDMI OUT B/ZONE 2 jack can be used for the Zone 2 output.

- 1 Select [Setup] - [HDMI Settings] from the home menu.
- 2 Select [HDMI OUT B Mode].
- 3 Select the setting you want.
 - **Main:** Uses the jack for HDMI OUT B output. Recommended when you enjoy TV or projector content in only one room (main zone).
 - **Zone2:** Uses the jack for the Zone 2 output. Recommended when you enjoy video and sound from a device connected to the unit in another room (Zone 2).

Note

- When [Zone2] is selected, the [Control for HDMI] and [Standby Linked to TV] functions do not work. For details on selecting the Zone 2 input, see [“Enjoying video and sound on the amplifier and TV in Zone 2.”](#)
- When [HDMI OUT B Mode] in [HDMI Settings] is set to [Zone2], the video signals that can be played are limited depending on the input as follows:
 - GAME, MEDIA BOX:
up to 4K/60p 4:4:4
 - VIDEO, SACD/CD:
up to 4K/60p 4:2:0

Multi Channel AV Receiver/Multi Channel AV Amplifier
STR-AN1000/TA-AN1000

Check information about the monitor connected via HDMI (Monitor Information)

You can display information about the monitor connected to the HDMI OUT A (TV) and HDMI OUT B/ZONE 2 jacks of the unit.

- 1 Select **[Setup]** - **[HDMI Settings]** from the home menu.
- 2 Select **[Monitor Information]**.

Setting HDMI signal formats (HDMI Signal Format)

You can select the signal format so that the unit can receive high resolution 4K or 8K signals.

- 1 Select [Setup] - [HDMI Settings] from the home menu.
- 2 Select [HDMI Signal Format].
- 3 Select the HDMI input you want to apply the setting from the HDMI IN jacks.
- 4 Select the setting you want.
 - **Standard format:** Selects this setting if you do not use the enhanced format.
 - **Enhanced format:** Selects this setting when inputting 4K format signals up to 4K/60p.
 - **Enhanced format (4K120, 8K):** Selects this setting when inputting signals in high-definition formats such as 4K/120p or 8K.

Note

- The HDMI jacks that can be set to [Enhanced format (4K120, 8K)] are only the GAME (for AUDIO) jack and MEDIA BOX jack.
- When [Enhanced format (4K120, 8K)] is selected, use an Ultra High Speed HDMI Cable (Ethernet compatible) that supports 48 Gbps.
- When [Enhanced format] is selected, we recommend using a Premium High Speed HDMI Cable with Ethernet that supports 18 Gbps.
- When [Enhanced format] or [Enhanced format (4K120, 8K)] is selected, some devices (cable box or satellite box, Blu-ray Disc player, and DVD player) may not work properly. In this case, select [Standard format].
- If your TV has similar menu for high bandwidth video format, check the setting on the TV menu when you select [Enhanced format] or [Enhanced format (4K120, 8K)] on this unit. For details on the setting of the TV menu, refer to the operating instructions of the TV.
- For details about the high bandwidth video format, refer to "[Video formats supported by the unit.](#)"

Related Topic

- [About HDMI connections](#)

Multi Channel AV Receiver/Multi Channel AV Amplifier
STR-AN1000/TA-AN1000

Displaying the video from external input while watching TV (Video output for PIP/PBP-displayed TV)

When the input of the unit is TV, you can output the video from the device connected to the HDMI IN jack of the unit to the TV. Set this function when using the dual screen display function of the TV.

- 1 Select **[Setup]** - **[HDMI Settings]** from the home menu.
- 2 Select **[Video output for PIP/PBP-displayed TV]**.
- 3 Select **[On]**.

Multi Channel AV Receiver/Multi Channel AV Amplifier
STR-AN1000/TA-AN1000

Enjoying 360 spatial sound (360 Spatial Sound Mapping)

The 360 Spatial Sound Mapping function allows you to enjoy an amazing 360 Spatial Sound experience that makes the sound feel more spacious and as if there are more speakers in the room. In order to reproduce an accurate sound field, it is necessary to perform Auto Calibration in advance.

- 1 Select [Sound Effects] - [360SSM] from the home menu.
- 2 Select [On].

Note

- [360SSM] cannot be set to [On] unless Auto Calibration is performed.
- The speakers must be connected in the configuration of 4.0.0 channels or more.
- Perform Auto Calibration beforehand.
- When a BLUETOOTH device is connected and [Bluetooth Mode] is set to [Transmitter], [360SSM] setting cannot be used.
- This setting cannot be changed when headphones are connected.
- Select a speaker pattern that matches your speaker configuration by selecting [Manual Speaker Settings] - [Speaker Pattern] from the [Speaker Settings] menu.
- This setting is available when one of the following sound fields is selected:
 - [Multi Stereo] (except for 2-channel content)
 - [A.F.D.]
 - [A.F.D. Movie]
 - [Audio Enhancer] (except for 2-channel content)

Hint

- You can also press 360SSM on the remote control to activate or deactivate the [360 Spatial Sound Mapping] function.
- You can also select [360 Spatial Sound Mapping] from the [Audio Settings] in the [Setup] menu.

Multi Channel AV Receiver/Multi Channel AV Amplifier
STR-AN1000/TA-AN1000

Enjoying overwhelming sound spread and a powerful sense of presence (360 Spatial Sound Mapping)

The 360 Spatial Sound Mapping function allows you to enjoy an amazing 360 Spatial Sound experience that makes the sound feel more spacious and as if there are more speakers in the room.

- 1 Select **[Setup]** - **[Audio Settings]** from the home menu.
- 2 Select **[360 Spatial Sound Mapping]**.
- 3 Select **[On]**.

Note

- When a BLUETOOTH device is connected and [Bluetooth Mode] is set to [Transmitter], [360 Spatial Sound Mapping] setting cannot be used.
- This setting cannot be changed when headphones are connected.
- Select a speaker pattern that matches your speaker configuration by selecting [Manual Speaker Settings] - [Speaker Pattern] from the [Speaker Settings] menu.
- This setting is available when one of the following sound fields is selected:
 - [Multi Stereo] except for 2-channel content
 - [A.F.D.]
 - [A.F.D. Movie]
 - [Audio Enhancer] except for 2-channel content

Hint

- You can also press 360SSM on the remote control to activate or deactivate the [360 Spatial Sound Mapping] function.

Calibrating speaker positioning (SpeakerRelocation / PhantomSurroundBack)

This function calibrates the speaker positioning (angle of each speaker's configuration from the measurement position) based on the measurement results of D.C.A.C. IX (Digital Cinema Auto Calibration) function to bring the sound closer to the surround-sound effect obtained with ideal speaker positioning. Thus, for example, this function can allow you to enjoy a surround-sound effect acoustically equivalent to that of a 7.1.2-channel speaker system, using only a 5.1.2-channel speaker system.

1 Select [Setup] - [Audio Settings] from the home menu.

2 Select [SpeakerRelocation / PhantomSurroundBack].

3 Select the setting you want.

- Type A:** This function adjusts each speaker's distance and angle to simulate the sound of an ideally placed surround system. When surround speakers are available, the surround back speakers sound as if they have been placed on the back wall.

When height speakers such as front high speakers or top middle speakers are available, the height speakers sound as if they have been placed on each side directly aligned with the front speakers.

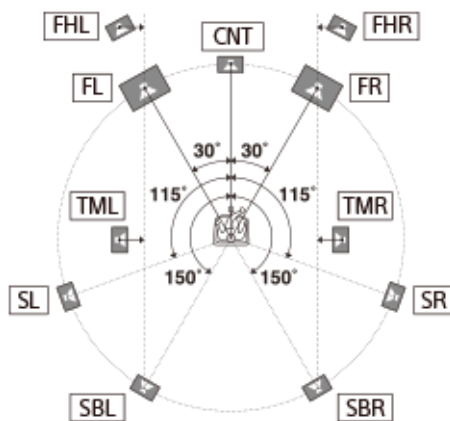

- Type B:** This function adjusts each speaker's distance and angle to simulate the sound of an ideally placed surround system. When surround speakers are available, the 4 surround speakers sound as if they have been placed at the identical angle.

When height speakers such as front high speakers or top middle speakers are available, the height speakers sound as if they have been placed on each side directly aligned with the front speakers.

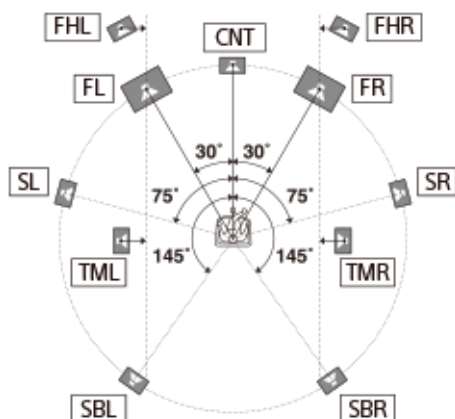

- **Off:** Speaker positioning is not relocated.

Note

- This function does not work in the following cases:
 - [Direct] is being used and an analog input is selected.
 - [In-Ceiling Speaker Mode] is set to [Front & Center] or [Front].
 - [DSD Native] is set to [On] and DSD signals are being played back.
- Perform Auto Calibration before using the [SpeakerRelocation / PhantomSurroundBack] function.

5-037-030-11(5) Copyright 2022 Sony Corporation

Multi Channel AV Receiver/Multi Channel AV Amplifier
STR-AN1000/TA-AN1000

Enabling the direct playback of DSD signals (DSD Native)

You can set the unit to process DSD (Direct Streaming Digital) signals directly without any signal conversion to PCM signals and derive intrinsic sound quality of DSD signals.

- 1 Select **[Setup]** - **[Audio Settings]** from the home menu.
- 2 Select **[DSD Native]**.
- 3 Select the setting you want.
 - **On:** This function is applied to the DSD signals.
 - **Off:** DSD signals are converted to PCM signals and played back.

Note

- This function does not work in the following cases:
 - [Bluetooth Mode] is set to [Transmitter].
- When [DSD Native] is set to [On] and DSD signals are being played back, the settings of [Equalizer] and [Subwoofer Low Pass Filter], etc., are invalid, and the sound field does not work.

Multi Channel AV Receiver/Multi Channel AV Amplifier
STR-AN1000/TA-AN1000

Enjoying high-fidelity sound (Pure Direct)

You can enjoy higher-fidelity sound from all inputs using the [Pure Direct] function. When the [Pure Direct] function is on, the display panel lights off to suppress noise that affects sound quality.

- 1 Select [Sound Effects] - [Pure Direct] from the home menu.
- 2 Select [On].

Canceling [Pure Direct]

The [Pure Direct] function will be canceled when you perform the following:

- Select [Off] in step 2.
- Press PURE DIRECT.
- Change the sound field.
- Change the following settings in the [Speaker Settings] menu:
 - [Auto Calibration Settings] - [Automatic Phase Matching]
 - [Auto Calibration Settings] - [Calibration Type]
 - [Manual Speaker Settings] - [Equalizer]
 - [TV/Screen Center Settings] - [In-Ceiling Speaker Mode]

Note

- [Automatic Phase Matching], [Calibration Type], [Equalizer], [In-Ceiling Speaker Mode] and [360 Spatial Sound Mapping] do not work when the [Pure Direct] function is selected.

Hint

- You can also use PURE DIRECT on the remote control or the unit to turn the [Pure Direct] function on or off.
- You can also select [Pure Direct] from [Audio Settings] in [Setup] menu.

Multi Channel AV Receiver/Multi Channel AV Amplifier
STR-AN1000/TA-AN1000

Setting the low-pass filter for the subwoofer output (Subwoofer Low Pass Filter)

You can turn the low-pass filter for the subwoofer output on or off. You can set the function for each input to which an audio input jack is assigned independently. Turn the function on if you connect a subwoofer without the crossover frequency function.

- 1 Select **[Setup]** - **[Audio Settings]** from the home menu.
- 2 Select **[Subwoofer Low Pass Filter]**.
- 3 Select the setting you want.
 - **On:** Always activates the low-pass filter with a cutoff frequency of 120 Hz.
 - **Off:** Does not activate the low-pass filter.

Note

- This function does not work in the following cases:
 - [Bluetooth Mode] is set to [Transmitter].
 - [DSD Native] is set to [On] and DSD signals are being played back.

Multi Channel AV Receiver/Multi Channel AV Amplifier
STR-AN1000/TA-AN1000

Synchronizing audio with video output (A/V Sync)

You can delay the output of audio to minimize the time gap between audio output and a visual display.

You can set the function for each input independently.

- 1 Select **[Setup]** - **[Audio Settings]** from the home menu.
- 2 Select **[A/V Sync]**.
- 3 Select the setting you want.
 - **0 ms – 300 ms:** You can adjust the delay from 0 ms to 300 ms in 10 ms intervals.
 - **HDMI Auto:** The time gap between the audio output and visual display of a TV connected via an HDMI connection will be adjusted automatically. This function is available only when the TV supports the **[A/V Sync]** function.

Note

- The unit may play signals at a lower sampling frequency than the actual sampling frequency of the input signals, depending on the audio format.
- This function is not available in the following cases:
 - **[Bluetooth Mode]** is set to **[Transmitter]**.
 - **[DSD Native]** is set to **[On]** and DSD signals are being played back.

Multi Channel AV Receiver/Multi Channel AV Amplifier
STR-AN1000/TA-AN1000

Selecting the language of digital broadcasts (Dual Mono)

You can select the language you want when listening to a digital broadcast with dual audio. This function only works for MPEG-2 AAC or Dolby Digital sources.

- 1 Select **[Setup]** - **[Audio Settings]** from the home menu.
- 2 Select **[Dual Mono]**.
- 3 Select the setting you want.
 - **Main:** Sound in the main language will be output.
 - **Sub:** Sound in the sub language will be output.
 - **Main/Sub :** Sound in the main language will be output through the front left speaker and sound in the sub language will be output through the front right speaker simultaneously.

Multi Channel AV Receiver/Multi Channel AV Amplifier
STR-AN1000/TA-AN1000

Making small sounds easier to hear (Audio DRC)

When listening to a BD or DVD that supports audio DRC at a low volume, this function makes it easier to hear quieter sounds.

- 1 Select **[Setup]** - **[Audio Settings]** from the home menu.
- 2 Select **[Audio DRC]**.
- 3 Select the setting you want.
 - **Auto** : This function is automatically enabled if there is additional information that recommends the use of this function in the source.
 - **On**
 - **Off**

Note

- [Audio DRC] is effective only when playing Dolby Digital, Dolby Digital Plus and Dolby TrueHD.
- For Dolby TrueHD, this function is effective only when the disk contains DRC information.

Multi Channel AV Receiver/Multi Channel AV Amplifier
STR-AN1000/TA-AN1000

Upmixing the 2-channel sound source (Upmixer)

You can perform a pseudo upmix of a 2-channel sound source according to your surround environment.

- 1 Select [Setup] - [Audio Settings] from the home menu.
- 2 Select [Upmixer].
- 3 Select the setting you want.
 - **Auto:** Upmix is performed according to the surround environment.
 - **Off**

Note

- This function does not work in the following cases:
 - [Bluetooth Mode] is set to [Transmitter].
 - The sound field is set to [2ch Stereo], [Direct] or [Headphone (2ch)].

Multi Channel AV Receiver/Multi Channel AV Amplifier
STR-AN1000/TA-AN1000

Selecting virtual sound effects (Virtualizer)

Set the virtual surround effects. By emphasizing the surround and height speaker channel audio, you can enjoy immersive audio.

1 Select [Setup] - [Audio Settings] from the home menu.

2 Select [Virtualizer].

3 Select the setting you want.

- **Dolby Speaker Virtualizer:** Even with two speakers, the audio is converted to virtual surround sound that reproduces 2-channel and 5.1-channel content.
- **DTS Virtual:X:** Even with two speakers, the audio is converted to 3D surround that spreads the sound upward, left/right, and backward.
- **Off**

Note

- Depending on the selected sound field setting or audio format, the virtualizer may function differently from the settings.
- This function does not work in the following cases:
 - [Bluetooth Mode] is set to [Transmitter].
 - The sound field is set to [2ch Stereo], [Direct] or [Headphone (2ch)].
 - A height/overhead speaker is connected, or a wireless speaker with built-in enabled speaker is connected.

Multi Channel AV Receiver/Multi Channel AV Amplifier
STR-AN1000/TA-AN1000

Switching the IMAX Mode (IMAX Mode)

Set whether to add the effect to the audio as if you were watching it at home in the theater when you play IMAX Enhanced content.

- 1 Select **[Setup]** - **[Audio Settings]** from the home menu.
- 2 Select **[IMAX Mode]**.
- 3 Select the setting you want.
 - **Auto:** IMAX effect is automatically added when you play IMAX Enhanced content.
 - **Off**

Multi Channel AV Receiver/Multi Channel AV Amplifier
STR-AN1000/TA-AN1000

Setting the speaker frequency when playing IMAX content (IMAX Adjustment)

Adjust each speaker you use when watching the IMAX Enhanced content.

- 1 Select **[Setup]** - **[Audio Settings]** from the home menu.
- 2 Select **[IMAX Adjustment]**.
- 3 Select the setting you want.
 - **HPF/Crossover:** Sets the crossover frequency of speakers other than the subwoofer. (Default setting: Auto, 40 Hz to 200 Hz)
 - **LPF for Subwoofer:** Sets the crossover frequency of the subwoofer. (Default setting: Auto, 40 Hz to 200 Hz)
 - **Subwoofer Volume:** Sets the volume of the subwoofer playing the IMAX Enhanced contents.
 - **Redirect to Subwoofer:** Redirects the low frequency band of the IMAX signal to the subwoofer. When this setting is set to **[On]**, the bass with the bass management function is output even while playing IMAX content. When this setting is set to **[Off]**, the bass that IMAX content has is output.

Multi Channel AV Receiver/Multi Channel AV Amplifier
STR-AN1000/TA-AN1000

Setting up Zone 2 (Zone2 Settings)

- 1** Connect a TV or amplifier/receiver and speakers.
- 2** Turn on the amplifier/receiver and TV in Zone 2.
- 3** Turn on the TV and the unit in the main zone.
- 4** Select [Setup] - [Zone Settings] from the home menu.
- 5** Select [Zone2 Settings].
Follow the instructions on the TV screen to make connections and settings.
- 6** Select [Confirm changes].

Multi Channel AV Receiver/Multi Channel AV Amplifier
STR-AN1000/TA-AN1000

Setting up Zone 3 (Zone3 Settings)

- 1** Connect a TV or amplifier/receiver and speakers.
- 2** Turn on the amplifier/receiver in Zone 3.
- 3** Turn on the TV and the unit in the main zone.
- 4** Select [Setup] - [Zone Settings] from the home menu.
- 5** Select [Zone3 Settings].
Follow the instructions on the TV screen to make connections and settings.
- 6** Select [Confirm changes].

Multi Channel AV Receiver/Multi Channel AV Amplifier
STR-AN1000/TA-AN1000

Setting the volume control for Zone 3 (Zone3 Line Out)

You can set variable or fixed volume control for the AUDIO ZONE 3 OUT jacks.

- 1 Select **[Setup]** - **[Zone Settings]** from the home menu.
- 2 Select **[Zone3 Line Out]**.
- 3 Select the setting you want.
 - **Variable:** Select when you cannot adjust the volume level on the amplifier in Zone 3. The volume level of the output from AUDIO ZONE 3 OUT jacks on the rear of the unit will become adjustable.
 - **Fixed:** Select to adjust the volume on the amplifier in Zone 3. The volume level of the output from AUDIO ZONE 3 OUT jacks on the rear of the unit will be fixed.

Note

- When [Variable] is set, the volume level is turned down by default. Turn up the volume while listening to the sound after completing setup. The volume for the SPEAKERS SURROUND BACK/HEIGHT (FRONT B/BI-AMP/ZONE 3) terminals is changed together with the volume for the AUDIO ZONE 3 OUT jacks.

Related Topic

- [Enjoying sound using another amplifier in Zone 3](#)

Multi Channel AV Receiver/Multi Channel AV Amplifier
STR-AN1000/TA-AN1000

Selecting the BLUETOOTH mode (Bluetooth Mode)

You can enjoy content from remote devices via this unit, or listen to sound from this unit via a BLUETOOTH receiver such as headphones or speakers.

- 1 Select **[Setup]** - **[Bluetooth Settings]** from the home menu.
- 2 Select **[Bluetooth Mode]**.
- 3 Select the setting you want.
 - **Receiver:** This unit is in receiver mode which enables it to receive and output audio from a BLUETOOTH device.
 - **Transmitter:** This unit is in transmitter mode which enables it to send audio to a BLUETOOTH receiver (headphones/speakers).
[BT TX] appears on the display panel.
 - **Off:** The BLUETOOTH power will be turned off and you will not be able to use the BLUETOOTH function.

Note

- [Bluetooth Mode] cannot be switched while the input of this unit is set to [Bluetooth Audio].
- No sound is output from the speakers connected to this unit when [Bluetooth Mode] is set to [Transmitter].
- In [Transmitter] mode, this unit can send audio to up to 1 device.

Hint

- You can set the transmission data rate for LDAC playback using [Wireless Playback Quality] in the [Bluetooth Settings].
- If you connect to this unit from your smartphone while [Transmitter] is selected and no other BLUETOOTH receiver is connected to this unit, the setting automatically switches to [Receiver] and you can listen to the sound from your smartphone via this unit.
- You can also switch between BLUETOOTH RX (Receiver) mode and BLUETOOTH TX (Transmitter) mode by pressing BLUETOOTH TX/RX on the remote control.
- Depending on the BLUETOOTH receiver, you can adjust the volume of the BLUETOOTH receiver from this unit when [Transmitter] is selected.

Multi Channel AV Receiver/Multi Channel AV Amplifier
STR-AN1000/TA-AN1000

Checking the BLUETOOTH device list (Device List)

You can check a list of the paired and detected BLUETOOTH receivers such as headphones when [Bluetooth Mode] is set to [Transmitter]. You can perform pairing with detected devices from the list.

- 1 Select [Setup] - [Bluetooth Settings] from the home menu.
- 2 Select [Device List].

Hint

- Select [Scan] to refresh the list.

Related Topic

- [Selecting the BLUETOOTH mode \(Bluetooth Mode\)](#)

Multi Channel AV Receiver/Multi Channel AV Amplifier
STR-AN1000/TA-AN1000

Setting the connection quality for listening to audio of a mobile device using this unit (Bluetooth Connection Quality)

You can set the BLUETOOTH connection quality during BLUETOOTH playback. Select whether to prioritize sound quality or connection.

- 1 Select [Setup] - [Bluetooth Settings] from the home menu.
- 2 Select [Bluetooth Connection Quality].
- 3 Select the setting you want.
 - **Priority on Sound Quality:** Gives priority to sound quality. Select this setting if the connection is stable.
 - **Priority on Stable Connection:** Gives priority to BLUETOOTH connection. Select this setting if the sound is easily interrupted.

Note

- This setting cannot be selected in the following cases:
 - [Bluetooth Mode] is set to [Off].
 - A BLUETOOTH device is connected.

Multi Channel AV Receiver/Multi Channel AV Amplifier
STR-AN1000/TA-AN1000

Setting the BLUETOOTH sound quality (Wireless Playback Quality)

You can set the transmission data rate for BLUETOOTH playback.

- 1 Select [Setup] - [Bluetooth Settings] from the home menu.
- 2 Select [Wireless Playback Quality].
- 3 Select the setting you want.
 - **LDAC Sound Quality:** Enables LDAC codec and the highest bit rate is used. Sound is sent in a higher quality; however, audio playback sometimes may become unstable when the link quality is not good enough. If audio playback is unstable in this mode, select [LDAC Stable Connection (Auto)].
 - **LDAC Stable Connection (Auto):** Enables LDAC codec and the data transfer rate is automatically changed depending on the environment.
 - **SBC Sound Quality:** Enables SBC codec. A medium data rate is used. This provides a balance between sound quality and playback stability.
 - **SBC Stable Connection (Auto):** Enables SBC codec and the data transfer rate is automatically changed depending on the environment. This setting is recommended if the connection is unstable.

Note

- This function is only available when [Bluetooth Mode] is set to [Transmitter].

Hint

- LDAC is an audio compression technology that enables transmission via BLUETOOTH of high-resolution audio sources, developed by Sony. Unlike the existing compression technology for BLUETOOTH such as SBC, it processes high-resolution audio sources without down-converting them to low frequencies and low bit numbers (*1). In addition, by applying extremely efficient coding and optimizing packet distribution, it is possible to transmit data volume that is about three times that of conventional technology (*2), realizing unprecedented high-quality BLUETOOTH wireless transmission.

*1 Excludes DSD format

*2 Comparison with SBC (Subband Coding) when a bit rate of 990 kbps (96/48 kHz) or 909 kbps (88.2/44.1 kHz) is selected

Multi Channel AV Receiver/Multi Channel AV Amplifier
STR-AN1000/TA-AN1000

Selecting the language used on the menu of the unit displayed on the TV (Language)

You can set the language for the menu of the unit displayed on the TV screen.

- 1 Select [Setup] - [System Settings] from the home menu.
- 2 Select [Language].
- 3 Select the language for the menu display of the unit.

Note

- When the Control for HDMI function on both the unit and the TV (BRAVIA TV) is turned on, the on-screen display language of the unit is changed simultaneously when you change the language for the on-screen display of the TV. However, if you select a language that is not supported by the unit when you set the language on the TV, the unit's on-screen display language will not change.

Multi Channel AV Receiver/Multi Channel AV Amplifier
STR-AN1000/TA-AN1000

Displaying the information on the screen when any settings are changed (Auto Display)

You can turn on or off the information display which appears on the TV screen when the volume level or sound field, etc., of the unit is changed.

1 Select [Setup] - [System Settings] from the home menu.

2 Select [Auto Display].

3 Select the setting you want.

- On
- Off

Multi Channel AV Receiver/Multi Channel AV Amplifier
STR-AN1000/TA-AN1000

Turning on the unit via the network or BLUETOOTH function (Network/Bluetooth Standby)

You can set the unit so that you can turn on the unit by operating mobile devices, etc. even while the unit is in standby mode.

- 1 Select **[Setup]** - **[System Settings]** from the home menu.
- 2 Select **[Network/Bluetooth Standby]**.
- 3 Select **[On]** or **[Off]**.
 - **On:** You can turn the unit on via the network or BLUETOOTH function.
 - **Off:** You can save power in standby mode. It may take time for sound to be output from the optional subwoofer or rear speakers after turning the unit on in this mode.

Note

- If you agree to use the Chromecast built-in function, **[Network/Bluetooth Standby]** automatically switches to **[On]**.
- If you set **[RF Channel]** to **[On]**, **[Network/Bluetooth Standby]** automatically switches to **[On]**.

Multi Channel AV Receiver/Multi Channel AV Amplifier
STR-AN1000/TA-AN1000

Setting the unit to switch to standby mode automatically (Auto Standby)

You can set the unit to switch to standby mode automatically when you do not operate the unit or when no signals are input to the unit.

1 Select [Setup] - [System Settings] from the home menu.

2 Select [Auto Standby].

3 Select [On] or [Off].

When you select [On], the unit switches to standby mode automatically in about 20 minutes if there is no operation.

Note

- This function does not work in the following cases:
 - [FM TUNER] is selected as the input (for US, Canadian, and Asia-Pacific models only).
 - The software of the unit is being updated.
 - BLUETOOTH receiver (headphones/speakers) are connected.
 - [DSD Native] is set to [On] and DSD signals are being played back.

Multi Channel AV Receiver/Multi Channel AV Amplifier
STR-AN1000/TA-AN1000

Switching the brightness of the display panel (Dimmer)

You can switch the brightness of the display panel.

- 1 Select [Setup] - [System Settings] from the home menu.
- 2 Select [Dimmer].
- 3 Select the setting you want.
 - Bright
 - Dark
 - Off

Hint

- You can also select the setting using the DIMMER on the unit.

Multi Channel AV Receiver/Multi Channel AV Amplifier
STR-AN1000/TA-AN1000

Assigning a name to the unit (Device Name Setting)

You can assign a device name to the unit to make it easily recognizable by other devices.

- 1** Select **[Setup]** - **[System Settings]** from the home menu.
- 2** Select **[Device Name Setting]**.
An on-screen keyboard appears on the TV screen.
- 3** Press **▲** (up)/**▼** (down)/**◀** (left)/**▶** (right) and **⊕** (enter) to select characters one by one to enter the name.
- 4** Select **[Enter]**.
The name you entered is registered.

Multi Channel AV Receiver/Multi Channel AV Amplifier
STR-AN1000/TA-AN1000

Checking the software version and MAC address of the unit (System Information)

You can display the software version information and MAC address of the unit.

- 1 Select **[Setup]** - **[System Settings]** from the home menu.
- 2 Select **[System Information]**.

Multi Channel AV Receiver/Multi Channel AV Amplifier
STR-AN1000/TA-AN1000

Checking software license information (Software License Information)

You can check the software license information.

- 1 Select [Setup] - [System Settings] from the home menu.
- 2 Select [Software License Information].
- 3 Follow the on-screen instructions.

Multi Channel AV Receiver/Multi Channel AV Amplifier
STR-AN1000/TA-AN1000

Setting the FM station receiving mode (FM Mode) (for US, Canadian, and Asia-Pacific models only)

You can set the FM station receiving mode to the stereo mode or monaural mode.

- 1 Select [Setup] - [System Settings] from the home menu.
- 2 Select [FM Tuner Settings].
- 3 Select [FM Mode].
- 4 Select the setting you want.
 - **Stereo:** The FM station is received in stereo.
 - **Monaural:** The FM station is received in monaural.





Hint

- If the FM stereo reception is poor, it may be improved by setting [FM Mode] to [Monaural].

Multi Channel AV Receiver/Multi Channel AV Amplifier
STR-AN1000/TA-AN1000

Naming preset stations (Preset Name Input) (for US, Canadian, and Asia-Pacific models only)

You can change the names of preset FM stations via the following procedure. Select the target FM station in advance by selecting [Listen] - [FM TUNER] from the home menu and then selecting the station from the preset list on the FM screen.

- 1 Select [Setup] - [System Settings] from the home menu.**
- 2 Select [FM Tuner Settings].**
- 3 Select [Preset Name Input].**
An on-screen keyboard appears on the TV screen.
- 4 Press  (up)/ (down)/ (left)/ (right) and  (enter) to select characters one by one to enter the name.**
- 5 Select [Enter].**
The name you entered is registered.

Canceling naming input

Press BACK before Step 5.

Note

- Some letters that can be displayed on the TV screen cannot be displayed on the display panel.

Multi Channel AV Receiver/Multi Channel AV Amplifier
STR-AN1000/TA-AN1000

Presetting the gain level of the FM tuner (Preset Gain Level) (for US, Canadian, and Asia-Pacific models only)

You can preset the gain level of the FM tuner.

- 1 Select [Setup] - [System Settings] from the home menu.
- 2 Select [FM Tuner Settings].
- 3 Select [Preset Gain Level].
- 4 Press **▲** (up)/**▼** (down) to adjust the gain level.

Multi Channel AV Receiver/Multi Channel AV Amplifier
STR-AN1000/TA-AN1000

Updating the software (Software Update)

By updating your software to the latest version, you can take advantage of the newest functions.

The new software is available when:

- the [UPDATE] indicator lights up on the display panel.
- a message of the unit appears on the TV screen if the [Software Update Notification] is set to [On].

Note

- Do not turn the unit off or disconnect the AC power cord (mains lead) and the LAN cable until the download and update processes are completed. Doing so may cause a malfunction.

1 When you use Sony wireless rear speakers/subwoofer (not supplied), turn on each speaker and make sure the connection with the unit is established.

The power indicator of the Sony wireless rear speakers/subwoofer (not supplied) lights up in green.

2 Select [Setup] - [Software Update] from the home menu.

3 Select [Network Update] or [USB Update].

If you select [USB Update], please visit the following customer support website to download the latest software version.

For customers in Americas:

<https://www.sony.com/am/support>

For customers in Europe:

<https://www.sony.eu/support>

For customers in Asia-Pacific countries and regions:

<https://www.sony-asia.com/support>

4 Check the software update progress.

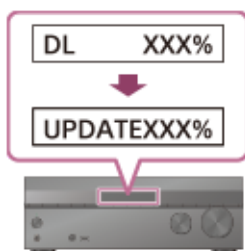

The progress rate is displayed in percentage.

The progress of loading software will be displayed as [DL XXX%] for the network update, and [RD XXX%] for the USB update.



When the update is completed, [COMPLETED] appears on the display panel and the unit restarts automatically.

Note

- It may take up to about 20 minutes for the update to be completed.
- You cannot restore the old version after updating the software.
- Set [Auto Update Settings] to [On] when you want to perform software updates automatically. Depending on the contents of the updates, software update may be performed even if you set [Auto Update Settings] to [Off].
- If the update of Sony wireless rear speakers/subwoofer (not supplied) does not work, move them closer to the unit and update them.

5-037-030-11(5) Copyright 2022 Sony Corporation

Multi Channel AV Receiver/Multi Channel AV Amplifier
STR-AN1000/TA-AN1000

Reverting to the factory default settings

If the unit still does not operate properly, reset the unit.

- 1 Select [Setup] - [Resetting] from the home menu.
- 2 Select [All Settings].
- 3 Select [Start].

To cancel resetting

Select [Cancel] in step 3.

If you cannot perform resetting using the home menu

With the unit turned off, press and hold  (power) on the unit for more than 10 seconds. The settings return to their initial status.









Note

- It takes a few minutes for the memory to be cleared completely. Do not turn the unit off until [RESET] appears on the display panel.
- By resetting, the link with the wireless subwoofer and rear speakers (not supplied) may be lost. In this case, reconnect them by referring to their operating instructions.

Multi Channel AV Receiver/Multi Channel AV Amplifier
STR-AN1000/TA-AN1000

Operating the unit with the menu on the display panel

You can operate this unit using the display panel even if the TV is not connected to the unit.

- 1 Press AMP MENU on the remote control.**
The menu is displayed on the display panel of the unit.
- 2 Press  (up)/ (down) repeatedly to select the menu you want, then press  (enter).**
- 3 Press  (up)/ (down) repeatedly to select the parameter you want to adjust, then press  (enter).**
- 4 Press  (up)/ (down) repeatedly to select the setting you want, then press  (enter).**

To return to the previous display

Press  (left) or BACK.

To exit the menu

Press AMP MENU on the remote control.

Note

- Some parameters and settings may appear dimmed on the display panel. This means that they are either unavailable or fixed and unchangeable.

Related Topic

- [Menu list \(on the display panel\)](#)
- [Indicators on the display panel](#)

Multi Channel AV Receiver/Multi Channel AV Amplifier
STR-AN1000/TA-AN1000

Menu list (on the display panel)

The following options are available in each menu.

Press AMP MENU on the remote control to display the menu on the display panel.

Input Settings [<INPUT>]

The following settings are available for each input.

- **Input Mode [INPUT MODE] (*1)**
AUTO, OPT, COAX, ANALOG
- **Naming inputs [NAME IN]**
- **Digital audio input assignment [A. ASSIGN]**
OPT, COAX, NONE

Speaker Settings [<SPEAKER>]

- **Speaker Configuration Selection [SPK CONFIG]**
PRESET1, PRESET2
- **Auto Calibration [AUTO CAL]**
- **Calibration Type [CAL TYPE]**
Full Flat, Engineer, Front Reference, OFF
- **Automatic Phase Matching [A.P.M.]**
AUTO, OFF

Level Settings [LEVEL>(*2)

- **Test Tone [TEST TONE] (*2)**
OFF, A. XXX -10.0 dB to XXX +10.0 dB, F. XXX -10.0 dB to XXX +10.0 dB (0.5 dB interval)
XXX represents a speaker channel. (FL, CNT, TV, FR, SR, SBR, SBL, SL, HL, HR, SW)
- **Front left speaker level [FL LEVEL]**
FL -10.0 dB to FL +10.0 dB (0.5 dB interval)
- **Center speaker level [CNT LEVEL]**
CNT -10.0 dB to CNT +10.0 dB (0.5 dB interval)
- **TV Center speaker level [TV LEVEL]**
TV -10.0 dB to TV +10.0 dB (0.5 dB interval)
- **Front right speaker level [FR LEVEL]**
FR -10.0 dB to FR +10.0 dB (0.5 dB interval)
- **Surround right speaker level [SR LEVEL]**
SR -10.0 dB to SR +10.0 dB (0.5 dB interval)
- **Surround back right speaker level [SBR LEVEL]**
SBR -10.0 dB to SBR +10.0 dB (0.5 dB interval)
- **Surround back left speaker level [SBL LEVEL]**
SBL -10.0 dB to SBL +10.0 dB (0.5 dB interval)

- **Surround left speaker level [SL LEVEL]**
SL -10.0 dB to SL +10.0 dB (0.5 dB interval)
- **Height left speaker level [HL LEVEL]**
HL -10.0 dB to HL +10.0 dB (0.5 dB interval)
- **Height right speaker level [HR LEVEL]**
HR -10.0 dB to HR +10.0 dB (0.5 dB interval)
- **Subwoofer Level [SW LEVEL]**
SW -10.0 dB to SW +10.0 dB (0.5 dB interval)
- **Distance from Listening Position [LISTN DIST.] (*2)**
 - Screen distance [SCR DIST.]
SCR 1.00 m to SCR 10.00 m (SCR 3'3" to SCR 32'9") (0.01 m (1 inch) interval)
 - Front left speaker distance [FL DIST.]
FL 1.00 m to FL 10.00 m (FL 3'3" to FL 32'9") (0.01 m (1 inch) interval)
 - Center speaker distance [CNT DIST.]
CNT 1.00 m to CNT 10.00 m (CNT 3'3" to CNT 32'9") (0.01 m (1 inch) interval)
 - Front right speaker distance [FR DIST.]
FR 1.00 m to FR 10.00 m (FR 3'3" to FR 32'9") (0.01 m (1 inch) interval)
 - Surround right speaker distance [SR DIST.]
SR 1.00 m to SR 10.00 m (SR 3'3" to SR 32'9") (0.01 m (1 inch) interval)
 - Surround back right speaker distance [SBR DIST.]
SBR 1.00 m to SBR 10.00 m (SBR 3'3" to SBR 32'9") (0.01 m (1 inch) interval)
 - Surround back left speaker distance [SBL DIST.]
SBL 1.00 m to SBL 10.00 m (SBL 3'3" to SBL 32'9") (0.01 m (1 inch) interval)
 - Surround left speaker distance [SL DIST.]
SL 1.00 m to SL 10.00 m (SL 3'3" to SL 32'9") (0.01 m (1 inch) interval)
 - Height left speaker distance [HL DIST.]
HL 1.00 m to HL 10.00 m (HL 3'3" to HL 32'9") (0.01 m (1 inch) interval)
 - Height right speaker distance [HR DIST.]
HR 1.00 m to HR 10.00 m (HR 3'3" to HR 32'9") (0.01 m (1 inch) interval)
 - Subwoofer distance [SW DIST.]
SW 1.00 m to SW 10.00 m (SW 3'3" to SW 32'9") (0.01 m (1 inch) interval)
- **Distance from the Screen [SCRN DIST.] (*2)**
 - Front left speaker distance [FL DIST.]
FL 0.00 m to FL 10.00 m (FL 0'0" to FL 32'9") (0.01 m (1 inch) interval)
 - Center speaker distance [CNT DIST.]
CNT 0.00 m to CNT 10.00 m (CNT 0'0" to CNT 32'9") (0.01 m (1 inch) interval)
 - Front right speaker distance [FR DIST.]
FR 0.00 m to FR 10.00 m (FR 0'0" to FR 32'9") (0.01 m (1 inch) interval)
 - Surround right speaker distance [SR DIST.]
SR 1.00 m to SR 10.00 m (SR 3'3" to SR 32'9") (0.01 m (1 inch) interval)
 - Surround back right speaker distance [SBR DIST.]

- SBR 1.00 m to SBR 20.00 m (SBR 3'3" to SBR 65'7") (0.01 m (1 inch) interval)
- Surround back left speaker distance [SBL DIST.]
 - SBL 1.00 m to SBL 20.00 m (SBL 3'3" to SBL 65'7") (0.01 m (1 inch) interval)
- Surround left speaker distance [SL DIST.]
 - SL 1.00 m to SL 10.00 m (SL 3'3" to SL 32'9") (0.01 m (1 inch) interval)
- Height left speaker distance [HL DIST.]
 - HL 0.00 m to HL 10.00 m (HL 0'0" to HL 32'9") (0.01 m (1 inch) interval)
- Height right speaker distance [HR DIST.]
 - HR 0.00 m to HR 10.00 m (HR 0'0" to HR 32'9") (0.01 m (1 inch) interval)
- **Height [HEIGHT] (*3)**
 - Screen height [SCR HEIGHT]
 - SCR 0.60 m to SCR 3.50 m (SCR 2'0" to SCR 11'6") (0.01 m (1 inch) interval)
 - Listening position height [LP HEIGHT]
 - LP 0.60 m to LP 3.00 m (LP 2'0" to LP 9'1") (0.01 m (1 inch) interval)
 - Ceiling height [CL HEIGHT]
 - CL 2.00 m to CL 10.00 m (CL 6'6" to CL 32'9") (0.01 m (1 inch) interval)
 - Front left speaker height [FL HEIGHT]
 - FL 0.00 m to FL 5.00 m (FL 0'0" to FL 16'5") (0.01 m (1 inch) interval)
 - Center speaker height [CNT HEIGHT]
 - CNT 0.00 m to CNT 5.00 m (CNT 0'0" to CNT 16'5") (0.01 m (1 inch) interval)
 - Front right speaker height [FR HEIGHT]
 - FR 0.00 m to FR 5.00 m (FR 0'0" to FR 16'5") (0.01 m (1 inch) interval)
 - Surround right speaker height [SR HEIGHT]
 - SR 0.00 m to SR 5.00 m (SR 0'0" to SR 16'5") (0.01 m (1 inch) interval)
 - Surround back right speaker height [SBR HEIGHT]
 - SBR 0.00 m to SBR 5.00 m (SBR 0'0" to SBR 16'5") (0.01 m (1 inch) interval)
 - Surround back left speaker height [SBL HEIGHT]
 - SBL 0.00 m to SBL 5.00 m (SBL 0'0" to SBL 16'5") (0.01 m (1 inch) interval)
 - Surround left speaker height [SL HEIGHT]
 - SL 0.00 m to SL 5.00 m (SL 0'0" to SL 16'5") (0.01 m (1 inch) interval)
 - Height left speaker height [HL HEIGHT]
 - HL 0.00 m to HL 10.00 m (HL 0'0" to HL 32'9") (0.01 m (1 inch) interval)
 - Height right speaker height [HR HEIGHT]
 - HR 0.00 m to HR 10.00 m (HR 0'0" to HR 32'9") (0.01 m (1 inch) interval)
 - Subwoofer height [SW HEIGHT]
 - SW 0.00 m to SW 1.00 m (SW 0'0" to SW 3'3") (0.01 m (1 inch) interval)
- **Size [SIZE] (*2)**
 - Front speakers size [FRT SIZE]
 - LARGE, SMALL
 - Center speaker size [CNT SIZE]
 - LARGE, SMALL
 - Surround speakers size [SUR SIZE]

LARGE, SMALL

- Height speakers size [HT SIZE]

LARGE, SMALL

- **Crossover Frequency [CROSS FREQ] (*4)**

- Front speakers crossover frequency [FRT CROSS]
CROSS 40 Hz to CROSS 200 Hz (10 Hz interval)
- Center speaker crossover frequency [CNT CROSS]
CROSS 40 Hz to CROSS 200 Hz (10 Hz interval)
- Surround speakers crossover frequency [SUR CROSS]
CROSS 40 Hz to CROSS 200 Hz (10 Hz interval)
- Height speakers crossover frequency [HT CROSS]
CROSS 40 Hz to CROSS 200 Hz (10 Hz interval)

- **Wireless Speaker Assign [W.SP ASSIGN]**

SUR SPK, SUR SPK SW, SB SPK, SB SPK SW, SW, OFF

- **Surround Back Speaker Assign [SB ASSIGN] (*5)**

ZONE3, BI-AMP, FRONT B, OFF

- **Speaker Pattern [SP PATTERN]**

- LISTENER LEVEL : 7.1 to 2.0 (20 patterns)
- HEIGHT/OVERHEAD : TM, FD, FH, SRD, FH+TM, FH+TR, FH+RH, TF+TM, TF+TR, TF+RH, TM+TR, TM+RH, TF+SRD, FD+TR, FD+SRD, FH+TM+TR, FH+TM+RH, TF+TMRH, TF+TM+TR, SBD, TF+SBD, FD+SBD, SRD+SBD, FD+SRD+SBD, 360RA REF., NOT USE (26 patterns)

- **Distance Unit [DIST. UNIT]**

METER, FEET

- **Wireless Speaker Settings [W.SP. SETTING]**

- Link mode [LINK MODE]
MANUAL, AUTO
- Start manual linking [START MANUAL LINKING]
START, CANCEL
- RF Channel [RF CHANNEL]
ON, OFF
- Wireless Playback Quality [W. QUALITY]
SOUND, CONNECTION

- **TV/Screen Center Settings [TV CNT SET]**

- TV Center Speaker Mode [TV CNT SPK]
ON, OFF
- Center Speaker Lift Up [CNT LIFT]
LIFT 1 to LIFT 10, LIFT OFF (*6) (*7)
- In-Ceiling Speaker Mode [IN-CEILING]
FRONT&CNT, FRONT, OFF

HDMI Settings [<HDMI>]

- **4K/8K Upscaling [4K/8K SCAL]**

AUTO, OFF

- **Control for HDMI [CTRL: HDMI]**
CTRL ON, CTRL OFF
- **Standby Linked to TV [STBY LINK]**
ON, AUTO, OFF
- **Standby Through [STBY THRU]**
ON, AUTO, OFF
- **Audio Return Channel [ARC SET] (*8)**
EARC, ARC, OFF
- **Audio Out [AUDIO OUT]**
AMP, TV+AMP
- **Subwoofer Level [SW LEVEL]**
SW AUTO, SW +10, SW 0
- **HDMI OUT B Mode [OUTB MODE]**
MAIN, ZONE
- **HDMI Signal Format [SIGNAL FMT.]**
The following settings are available in each HDMI input.
STANDARD, ENHANCED, (4K120, 8K) (Available for input from GAME, or MEDIA BOX jacks only.)
- **Video output for PIP/PBP-displayed TV [V. OUT PIP]**
ON, OFF

Audio Settings [<AUDIO>]

- **Sound Field [SOUND.FIELD]**
2CH STEREO, DIRECT, A.F.D., MULTI ST., DOLBY MODE, DTS:X MODE, A.F.D. MOVIE, A. ENHANCER, HP 2CH
- **360 Spatial Sound Mapping [360SSM]**
ON, OFF
- **SpeakerRelocation / PhantomSurroundBack [SP RELOCATION]**
TYPE A, TYPE B, OFF
- **DSD Native [DSD NATIVE]**
DSD ON, DSD OFF
- **Pure Direct [P. DIRECT]**
ON, OFF
- **Subwoofer Low Pass Filter [SW L.P.F.]**
ON, OFF
- **A/V Sync [A/V SYNC]**
0 ms to 300 ms (10 ms interval), HDMI AUTO
- **Dual Mono [DUAL MONO]**
MAIN/SUB, MAIN, SUB
- **Audio DRC [AUDIO DRC]**
AUTO, ON, OFF
- **Upmixer [UP MIXER]**
AUTO, OFF
- **Virtualizer [VIRTUAL]**
DY SPK VIRTUAL, DTS VIRTUAL:X, OFF
- **IMAX Mode [IMAX MODE]**

AUTO, OFF

- **IMAX Adjustment [IMAX.ADJUST]**

- HPF/Crossover [HPF/CROSS]
Set the crossover frequency of the speakers other than subwoofer.
40 Hz to 200 Hz (10 Hz interval), AUTO
- LPF for Subwoofer [LPF SW]
40 Hz to 200 Hz (10 Hz interval), AUTO
- Subwoofer Volume [SW VOL]
-10.0 dB to +10.0 dB (0.5 dB interval)
- Redirect to Subwoofer [REDIRECT.SW]
ON, OFF

Zone Settings [<ZONE>]

- **Zone3 Line Out [Z3 LINEOUT]**

VARIABLE, FIXED

Bluetooth Settings [<BT>]

- **Bluetooth Mode [BT MODE] (*9)**
RECEIVE, TRANSMIT, OFF
- **Bluetooth Connection Quality [QUALITY] (*10)**
SOUND, STABLE
- **Wireless Playback Quality [BT CODEC] (*11)**
LDAC, LDAC (AUTO), SBC, SBC (AUTO)

System Settings [<SYSTEM>]

- **Auto Display [AUTO DISP.]**
ON, OFF
- **Network/Bluetooth Standby [NET/BT.STBY] (*12)**
STBY ON, STBY OFF
- **Auto Standby [AUTO STBY]**
STBY ON, STBY OFF
- **FM Tuner Settings [TUNER] (for US, Canadian, and Asia-Pacific models only)**
 - FM Mode [FM MODE]
STEREO, MONO
 - Preset Name Input [NAME INPUT]
 - Preset Gain Level [PRESET GAIN LEVEL]
-12.0 dB to +12.0 dB (0.5 dB interval)

Equalizer [EQ]

- **Front speaker bass level [FRT BASS]**
FRT B. -10.0 dB to FRT B. +10.0 dB (1 dB interval)
- **Front speaker treble level [FRT TREBLE]**
FRT T. -10.0 dB to FRT T. +10.0 dB (1 dB interval)
- **Center speaker bass level [CNT BASS]**
CNT B. -10.0 dB to CNT B. +10.0 dB (1 dB interval)
- **Center speaker treble level [CNT TREBLE]**
CNT T. -10.0 dB to CNT T. +10.0 dB (1 dB interval)

- **Surround speaker bass level [SUR BASS]**
SUR B. -10.0 dB to SUR B. +10.0 dB (1 dB interval)

- **Surround speaker treble level [SUR TREBLE]**
SUR T. -10.0 dB to SUR T. +10.0 dB (1 dB interval)

- **Height speaker bass level [HT BASS]**
HT B. -10.0 dB to HT B. +10.0 dB (1 dB interval)

- **Height speaker treble level [HT TREBLE]**
HT T. -10.0 dB to HT T. +10.0 dB (1 dB interval)

*1 Selectable items change depending on the input.

*2 Some parameters or settings may not be available depending on the speaker pattern setting.

*3 You cannot select this setting in the following cases:

- Headphones are connected to the PHONES jack.
- [Bluetooth Mode] is set to [Transmitter].

*4 You cannot select this setting in the following cases:

- Headphones are connected to the PHONES jack.
- [Bluetooth Mode] is set to [Transmitter].
- [Size] for none of the speakers is set to [Small].

*5 You can select this setting in the following cases:

- [SP PATTERN] is not set to a pattern with surround back and height speakers. (i.e. 5.1, 5.0, 4.1, 4.0, 3.1, 3.0, 2.1, 2.0)
- Headphones are not connected to the PHONES jack.
- [Bluetooth Mode] is set to other than [Transmitter].

*6 You can only select this setting if [SP PATTERN] is set to a pattern with center speaker and front high speakers. (i.e. 5.1.2 (FH))

*7 You cannot select this setting in the following cases:

- Headphones are connected to the PHONES jack.
- [2ch Stereo] or [Multi Stereo] is being used.
- A sound field for music is being used.
- [Bluetooth Mode] is set to [Transmitter].
- [In-Ceiling Speaker Mode] is set to [Front & Center] or [Front].
- [DSD Native] is set to [On] and DSD signals are being played back.

*8 You can only select this setting when [Input Mode] for the TV input is set to [Auto].

*9 You cannot select this setting when the input of this unit is set to [Bluetooth Audio].

*10 You cannot select this setting in the following cases:

- [Bluetooth Mode] is set to [Transmitter] or [Off].
- A BLUETOOTH device is connected.

*11 You can only select this setting when [Bluetooth Mode] is set to [Transmitter].

*12 This setting automatically switches to [STBY ON] in the following cases:

- You agree to use the Chromecast built-in function.
- You set [RF Channel] to [On].

Multi Channel AV Receiver/Multi Channel AV Amplifier
STR-AN1000/TA-AN1000

If the unit does not work properly.

1 Search for the cause and solution of the issue by referring to this Help Guide.

The troubleshooting method is listed in “Troubleshooting.”

2 Search for the cause and solution of the issue on the Sony support site.

Sony support site provides latest support information and Frequently Asked Questions.

For customers in Americas:

<https://www.sony.com/am/support>

For customers in Europe:

<https://www.sony.eu/support>

For customers in Asia-Pacific countries and regions:

<https://www.sony-asia.com/support>

3 Reset the unit.

All the settings of the unit return to their initial status.

4 Should any problems persist, consult your nearest Sony dealer.

Related Topic

- [Reverting to the factory default settings](#)

Multi Channel AV Receiver/Multi Channel AV Amplifier
STR-AN1000/TA-AN1000

[PROTECTOR] or [THERMAL] appears on the display panel.



The unit will automatically turn off after a few seconds. Check the followings:

- There may be an electrical surge or power failure. Unplug the AC power cord (mains lead) and then plug in the cord again after 30 minutes.
- The unit is covered and the ventilation holes are blocked. Remove the object covering the ventilation holes of the unit.
- The impedance of the connected speakers is below the rated impedance range indicated on the back panel of the unit. Reduce the volume level.
- Unplug the AC power cord (mains lead) and let the unit cool down for 30 minutes while performing the following troubleshooting:
 - Disconnect all of the speakers and subwoofer.
 - Check that the speaker wires are tightly twisted on both ends.
 - Connect the front speaker first, increase the volume level and operate the unit for at least 30 minutes until it completely warms up. Then, connect each additional speaker one by one and test each additional speaker until you detect which speaker is causing the protection error.

After checking the above items and fixing any problems, plug in the AC power cord (mains lead) and turn on the unit. If the problem persists, consult your nearest Sony dealer.

Multi Channel AV Receiver/Multi Channel AV Amplifier
STR-AN1000/TA-AN1000

[ERROR] appears on the display panel.

- While USB Update is performed, insert a USB flash drive on which the package file for updating the unit is saved, and then turn the unit off and turn it on again.
- While Network Update is performed, press  (power). If the problem persists, insert a USB flash drive on which the package file for updating the unit is saved, and then press  (power) again.

Multi Channel AV Receiver/Multi Channel AV Amplifier
STR-AN1000/TA-AN1000

[Overload has been detected.] appears on the TV screen.

An over-current from the ψ (USB) port was detected. Disconnect the USB device as prompted in the warning message and close the message.

Multi Channel AV Receiver/Multi Channel AV Amplifier
STR-AN1000/TA-AN1000

List of messages after Auto Calibration measurements

- **Error 30:**
Headphones inserted. Remove headphones and re-measure.
- **Error 31:**
SPEAKERS(A/B/A+B/OFF) are off. Re-measure with audio coming out of the SPEAKERS (A/B/A+B/OFF). For details on the front speaker selection, see "[Selecting the front speakers.](#)"
- **Error 32:**
No sound was detected from any channel. Is the measurement microphone damaged? Is it connected to the CALIBRATION MIC jack on the front of this unit?
- **Error 34:**
Front speakers (*) are not installed in the correct position. Left/right of the microphone and speakers may be installed in reverse.
* The speaker name in this error message depends on the detected symptom.
- **Error 35:**
Center speaker (*) pattern settings and measurement results do not match. Check the center speaker pattern and connection.
* The speaker name in this error message depends on the detected symptom.
- **Error 36:**
3D position could not be measured. Microphone or microphone stand may be misaligned. Return to the correct position and try again. If noisy, measure with as little surrounding noise as possible.
- **Error 37:**
 - No sound was detected from either the left or right surround speakers. Is the power for the wireless speakers that are used as the surround speakers turned on?
 - No sound was detected from either the left or right surround back speakers. Is the power for the wireless speakers that are used as the surr. back speakers turned on?
 - To output audio from the connected wireless speakers, update software to the latest version. Press [HOME] on the remote for this unit and select "Setup" to update.
- **Error 38:**
It wasn't possible to measure correctly. Move the speaker or microphone position a little and try again. If noisy, measure with as little surrounding noise as possible.
- **Warning 40:**
Measurement complete, but it is noisy. It may be possible to measure again, but it is not possible to measure in all environments. Measure with as little surrounding noise as possible.
- **Warning 41, Warning 42:**
The input from the measurement microphone is excessive. The speaker and microphone may be too close. Place the speaker and microphone away from each other. If using this unit as a preamplifier, this message may be displayed depending on the connected power amplifier, but it can be used as it is.
- **Warning 43:**
The subwoofer distance and phase could not be measured. Noise may be the cause. Re-measure in a quiet surrounding environment.
- **Warning 44:**
Measurement finished, but the center speaker (*) positional relationship may be unsuitable. Check the speaker position referring to "Installing speakers" in the Help Guide.

* The speaker name in this warning message depends on the detected symptom.

5-037-030-11(5) Copyright 2022 Sony Corporation

Multi Channel AV Receiver/Multi Channel AV Amplifier
STR-AN1000/TA-AN1000

The unit is turned off automatically.

- If [Auto Standby] is set to [On], set it to [Off].
 - [PROTECTOR] or [THERMAL] was activated.
-

Related Topic

- [Setting the unit to switch to standby mode automatically \(Auto Standby\)](#)
- [\[PROTECTOR\] or \[THERMAL\] appears on the display panel.](#)

Multi Channel AV Receiver/Multi Channel AV Amplifier
STR-AN1000/TA-AN1000

Cannot find an available input when connecting several digital devices.

You can reassign the COAXIAL IN SA-CD/CD/OPTICAL IN TV jacks to other inputs.

See “[Using other digital audio input jacks \(Input Assign\)](#).”

Related Topic

- [Using other digital audio input jacks \(Input Assign\)](#)

Multi Channel AV Receiver/Multi Channel AV Amplifier
STR-AN1000/TA-AN1000

The unit does not turn on even when the TV is turned on.

- Set [Control for HDMI] to [On] in the [HDMI Settings] menu. The TV must support the Control for HDMI function. For details, refer to the operating instructions of your TV.
- Check the speaker settings of the TV. The unit power syncs with the speaker settings of the TV. For details, refer to the operating instructions of the TV.
- If sound was output from the speakers of the TV last time, the unit does not turn on even when the TV is turned on.

Multi Channel AV Receiver/Multi Channel AV Amplifier
STR-AN1000/TA-AN1000

The unit turns off when the TV is turned off.

Check [Standby Linked to TV] in the [HDMI Settings] menu. When the function is set to [On], the unit automatically turns off interlocked with the TV-power off operation, regardless of the input of the unit.

Multi Channel AV Receiver/Multi Channel AV Amplifier
STR-AN1000/TA-AN1000

The unit does not turn off even when the TV is turned off.

- Set [Setup] - [HDMI Settings] - [Control for HDMI] to [On]. The TV must support the Control for HDMI function. For details, refer to the operating instructions of your TV.
- Check [Standby Linked to TV] in the [HDMI Settings] menu.
If you want the unit to turn off when the TV is turned off regardless of the input of the unit, set [Standby Linked to TV] to [On].

No image appears on the TV screen.

- Try pressing the input button on the remote control or turning INPUT SELECTOR on the unit to select the input to which you want to watch.
- If the TV is connected to the HDMI OUT B/ZONE 2 jack, reconnect the TV to the HDMI OUT A (TV) jack.
- If the HDMI video signal output is set to [HDMI OFF] or [HDMI B], select [HDMI A] or [HDMI A+B] by pressing HDMI OUT on the unit or remote control.
- Set your TV to the appropriate input mode.
- Make sure that cables are correctly and securely connected to devices.
- Disconnect the HDMI cable from the unit and TV and then reconnect the cable.
- Change the [HDMI Signal Format] setting of the selected input in the [HDMI Settings] menu.
- Some playback devices need to be set up. Refer to the operating instructions supplied with each device.
- Be sure to use a Premium High Speed HDMI Cable with Ethernet, which supports bandwidths up to 18 Gbps. For video signals that require a high bandwidth such as 4K/120p, 8K, etc., be sure to use an Ultra High Speed HDMI Cable that supports bandwidths up to 48 Gbps.
- If you want to play HDCP 2.2 or HDCP 2.3 content, connect the unit to an HDMI input jack of a TV that is compatible with HDCP 2.2 or HDCP 2.3.
- Digital video signals input to the HDMI IN jacks of this unit are output only from the HDMI OUT A (TV) or HDMI OUT B/ZONE 2 jack. Analog video signals input to the VIDEO IN jacks are output only from the MONITOR OUT jack. For details, see "[About input/output of video signals.](#)"

Related Topic

- [Notes on connecting cables](#)
- [About HDMI connections](#)

Multi Channel AV Receiver/Multi Channel AV Amplifier
STR-AN1000/TA-AN1000

4K or 8K content cannot be displayed at the same resolution as the source.

- Depending on the TV or the video device, 4K or 8K content may not be displayed. Check the video capability and settings of your TV and video device.
 - Be sure to use a Premium High Speed HDMI Cable with Ethernet, which supports bandwidths up to 18 Gbps. For video signals that require a high bandwidth such as 4K/120p, 8K, etc., be sure to use an Ultra High Speed HDMI Cable that supports bandwidths up to 48 Gbps.
 - If your TV have similar menu for high bandwidth video format, check the setting on the TV menu. For details on the TV menu setting, refer to the operating instructions of the TV.
 - Be sure to connect the unit to an HDMI input jack of a TV or video device that is supporting 4K or 8K. You have to connect an HDMI cable to an HDMI jack that supports HDCP 2.2 or HDCP 2.3 when you use a playback device for 4K or 8K resolution video content, etc.
 - Disconnect the HDMI cable from the unit and TV and then reconnect the cable.
 - Supported video signals vary depending on the HDMI IN jack. For details on the supported video signals, see "[Connecting devices with HDMI jacks.](#)"
-

Related Topic

- [Notes on connecting cables](#)
- [About HDMI connections](#)

Multi Channel AV Receiver/Multi Channel AV Amplifier
STR-AN1000/TA-AN1000

No image is output to the TV from the connected HDMI device when the unit is in standby mode.

-
- When the unit enters standby mode, the image from the last HDMI device selected before you turned off the unit is displayed. If no image is output to the TV, perform the following operations.
 - Turn on the unit to select the HDMI device from which you want to enjoy content.
 - Make sure [Standby Through] is set to [Auto] or [On] in the [HDMI Settings] menu.
-

Related Topic

- [Enjoying content of a connected device without turning on the unit \(Standby Through\)](#)

Multi Channel AV Receiver/Multi Channel AV Amplifier
STR-AN1000/TA-AN1000

The home menu does not appear on the TV screen.

- The home menu can be displayed only when a TV is connected to the HDMI OUT jack of the unit.
- When the TV is connected to the HDMI OUT A (TV) jack, press HDMI OUT on the unit or remote control to select [HDMI A] or [HDMI A+B].
- If you want to display the home menu while the TV is connected to HDMI OUT B/ZONE 2 jack instead of HDMI OUT A (TV) jack, press AMP MENU on the remote control, set [<HDMI>] - [HDMI OUTB MODE] to [MAIN] while confirming the display panel, then press HDMI OUT to select [HDMI B] or [HDMI A+B].
- Press HOME to display the home menu.
- Check that the TV is connected correctly.
- Disconnect the HDMI cable from the unit and TV and then reconnect the cable.
- The home menu may take some time to appear on the TV screen depending on the TV.
- The home menu will not appear when the TV's video input is connected to the MONITOR OUT jack of the unit and the video input is selected on the TV. Connect the TV and the unit with an HDMI cable, and select the HDMI input on the TV.

Multi Channel AV Receiver/Multi Channel AV Amplifier
STR-AN1000/TA-AN1000

HDR (High Dynamic Range) images cannot be displayed in HDR mode.

- Depending on the TV or video equipment, HDR images may not be displayed in HDR mode. Check the video capability and setting of your TV or video equipment.
- Depending on the unit setting, some video equipment may not output HDR content in HDR mode due to lack of signal bandwidth, even if both TV and video equipment support HDR. In this case, set [HDMI Signal Format] of the selected input to [Enhanced format] or [Enhanced format (4K120, 8K)] in the [HDMI Settings] menu.

Multi Channel AV Receiver/Multi Channel AV Amplifier
STR-AN1000/TA-AN1000

The indicator on the display panel turns off.

- If the PURE DIRECT indicator on the front panel lights up, press PURE DIRECT to turn off this function.
 - Press DIMMER on the unit, and then adjust the brightness of the display panel.
-

Related Topic

- [Enjoying high-fidelity sound \(Pure Direct\)](#)
- [Switching the brightness of the display panel \(Dimmer\)](#)

Multi Channel AV Receiver/Multi Channel AV Amplifier
STR-AN1000/TA-AN1000

Image does not appear on the TV screen when the unit is not turned on.

- Set [Control for HDMI] to [On], and then set [Standby Through] to [Auto] or [On] in the [HDMI Settings] menu.
- Turn on the unit, then select the input to which the playing device is connected.
- If connected to other devices than those manufactured by Sony that support the Control for HDMI function, set [Control for HDMI] to [On] in the [HDMI Settings] menu.

Multi Channel AV Receiver/Multi Channel AV Amplifier
STR-AN1000/TA-AN1000

When the language for the on-screen display of the TV is changed, the on-screen display language of the unit is changed simultaneously.

Check [Control for HDMI] in the [HDMI Settings] menu. If [Control for HDMI] is set to [On], the on-screen display language of the unit may be changed simultaneously when you change the language for the on-screen display of the TV. Select the language on the unit again to return to the previous setting.

Related Topic

- [Selecting the language used on the menu of the unit displayed on the TV \(Language\)](#)

Multi Channel AV Receiver/Multi Channel AV Amplifier
STR-AN1000/TA-AN1000

No sound or only a very low level of sound is heard, no matter which device is selected.

- Check that all connecting cables are inserted to their input/output jacks on the unit, speakers and the devices.
- Check that the unit and all devices are turned on.
- Check that MASTER VOLUME on the unit is not set to [VOL MIN].
- Press SPEAKERS on the unit to select a setting other than [SPK OFF].
- Check that headphones are not connected to the unit.
- Press  to cancel the muting function.
- Try pressing the input button on the remote control or turning INPUT SELECTOR on the unit to select the input to which you want to watch.
- When [Control for HDMI] is set to [On] or [Audio Return Channel] is set to either [eARC] or [ARC] in the [HDMI Settings] menu:
 - Check that the speaker output setting on the TV is set to “Audio System.” If you want to listen to sound from the TV speaker, set it to “TV Speaker.”

When [Control for HDMI] is set to [Off] and [Audio Return Channel] is set to [Off] in the [HDMI Settings] menu:

- If you want to listen to sound from the TV speaker, set [Audio Out] to [TV + AMP] in the [HDMI Settings] menu. If you cannot play multi-channel audio source, set [AMP]. However, the sound will not be output through the TV speaker.
- Set [Bluetooth Mode] to other than [Transmitter].
- Set [DSD Native] in [Audio Settings] to [Off]. If the speaker assigned as a signal source is not installed, playback is not available during DSD Native playback because content will be played on the target speaker. Also, Zone output is not available because downmix process does not work.

Multi Channel AV Receiver/Multi Channel AV Amplifier
STR-AN1000/TA-AN1000

There is severe humming or noise.

- Check that the speakers and device are connected securely.
- Make sure that the connecting cables are not near a transformer or motor.
- Move your audio device away from the TV.
- If the plugs and jacks are dirty, wipe them with a cloth slightly moistened with alcohol.

No sound or only a very low level of sound is heard from specific speakers.

- Connect a pair of headphones to the PHONES jack to verify that sound is output from the headphones. If only one channel is output from the headphones, the device may not be connected to the unit correctly. Check that all of the cables are fully inserted into the jacks on both the unit and the device.
If both channels are output from the headphones, the front speaker may not be connected to the unit correctly. Check the connection of the front speaker that is not outputting any sound.
- Make sure you have connected to both the L and R jacks of an analog device, as analog devices require both L and R jack connections. Use an audio cable (not supplied).
- Adjust the speaker level.
- Check that the speaker settings are appropriate for the setup using [Manual Speaker Settings] – [Speaker Pattern] in the [Speaker Settings] menu. Then check that sound is output from each speaker correctly using [Manual Speaker Settings] – [Test Tone] in the [Speaker Settings] menu.
- Check that the subwoofer is connected correctly and securely.
- Make sure you have turned on your subwoofer.
- Check the volume on the subwoofer.
- Depending on the selected sound field, sound may not be available from the subwoofer.
- When you play content in the DTS format or the sound field is set to [DTS:X Mode], sound may not be output from the height speakers. In this case, set [Speaker Pattern] in [Manual Speaker Settings] under [Speaker Settings] to [5.1.2 (FH)].

Multi Channel AV Receiver/Multi Channel AV Amplifier
STR-AN1000/TA-AN1000

No sound is heard from the wireless speaker (not supplied).

- During DVD-Audio or SA-CD playback, no sound will be output from wireless speakers because of copyright protection restrictions. Switch the speaker configuration to wired connection.
- Make sure the [Manual Speaker Settings] - [Wireless Speaker Assign] in the [Speaker Settings] menu is completed. After selecting a speaker pattern for wireless speakers from the [Manual Speaker Settings] - [Speaker Pattern] in the [Speaker Settings] menu, set the speaker configuration you wish to use in the [Wireless Speaker Assign].

Multi Channel AV Receiver/Multi Channel AV Amplifier
STR-AN1000/TA-AN1000

Sound heard from the wireless speaker (not supplied) is unstable.

- Do not place metal objects other than a TV near the unit. The wireless function with the wireless speaker (not supplied) will be affected and the sound will become unstable.
- Do not put the unit in a metal rack. The wireless function with the wireless speaker (not supplied) will be affected and the sound will become unstable.
- If there is a device nearby that generates electromagnetic waves, such as a wireless LAN or a microwave oven in use, set the wireless speaker and the unit apart from it.
- If there is an obstacle between the wireless speaker and the unit, move or remove it.
- Set the wireless speaker and the unit in a position as close as possible.
- Select [Setup] - [Speaker Settings] - [Wireless Speaker Settings] from the home menu and set [RF Channel] to [Off], and then set it to [On] again.
- Switch the network connection of the TV or Blu-ray Disc player from wireless to wired.
- Select [Setup] - [Speaker Settings] - [Wireless Speaker Settings] from the home menu and set [Wireless Playback Quality] to [Connection].
- Install the speaker system and the wireless speaker at a distance of 1.5 m (5 ft) or more from a wireless LAN router, etc. It may be improved by changing the direction or the antenna's angle of the wireless LAN router.

Multi Channel AV Receiver/Multi Channel AV Amplifier
STR-AN1000/TA-AN1000

The sound is interrupted.

Sound may be interrupted when the sampling frequency, number of channels or audio format of audio output signals from the playback device is switched.

Multi Channel AV Receiver/Multi Channel AV Amplifier
STR-AN1000/TA-AN1000

When a TV is connected to the unit via an HDMI OUT A (TV) jack that supports the eARC or ARC function, sound from the TV is not output from the speakers connected to the unit.

-
- Set [Audio Return Channel] to [eARC] or [ARC] in the [HDMI Settings] menu.
 - Make sure that your TV is compatible with the eARC or ARC function.
 - Make sure that the HDMI cable is connected to a jack on your TV that is compatible with the eARC or ARC function.
 - If you connect the unit to a TV that is compatible with the ARC function but not compatible with the eARC function, set [Audio Return Channel] to [ARC] in the [HDMI Settings] menu.
 - If you connect the unit to a TV that is incompatible with both the eARC and ARC functions, set [Audio Return Channel] to [Off] in the [HDMI Settings] menu, and connect the TV to the OPTICAL IN TV jack of the unit with an optical cable.

Multi Channel AV Receiver/Multi Channel AV Amplifier
STR-AN1000/TA-AN1000

The center component of the audio is not output from the TV when using the TV as a center speaker by connecting the S-CENTER OUT jack of the unit to the S-CENTER SPEAKER IN jack of the TV. (The Acoustic Center Sync function is not working)

- Check that [Control for HDMI] is [On] in the [HDMI Settings] menu.
- Press HOME, select [Setup] – [Speaker Settings] – [TV/Screen Center Settings] – [TV Center Speaker Mode] and then set to [On].
- Select a sound field other than [2ch Stereo].
- The sound may not be output through the TV speaker depending on the sound source.
- When a BLUETOOTH device is connected and [Bluetooth Mode] is set to [Transmitter], or a headphone is connected, the sound will not be output through the TV speaker.

Multi Channel AV Receiver/Multi Channel AV Amplifier
STR-AN1000/TA-AN1000

Cannot select the desired input for playback in Zone 2 or Zone 3.

There are limits to the inputs that can be played in Zone 2 and Zone 3. For details, see "[Available input sources for each zone.](#)"

Multi Channel AV Receiver/Multi Channel AV Amplifier
STR-AN1000/TA-AN1000

No sound is heard from the active subwoofer or the center speaker.

- Sound may not be output from the target speakers depending on the playback signals or the speaker settings.
- Be sure to select the optimal sound field for the content. For details on relations between sound fields and speaker outputs, see "[Relations between sound fields and speaker outputs.](#)"

Multi Channel AV Receiver/Multi Channel AV Amplifier
STR-AN1000/TA-AN1000

Volume level of Zone 2 speakers cannot be adjusted.

- You can only select an input from the HDMI IN jacks in Zone 2. Since the audio signals are output from the HDMI OUT B/ZONE 2 jack as they are, you cannot adjust the volume level on the unit. Adjust the volume on the device connected to the HDMI OUT B/ZONE 2 jack.

Multi Channel AV Receiver/Multi Channel AV Amplifier
STR-AN1000/TA-AN1000

There is no sound from a specific device.

- Check that the device is correctly connected to the corresponding audio input jacks.
- Check that the cable(s) used for the connection is (are) fully inserted into the jacks on both the unit and the device.
- Check the [Input Mode] setting under [Assignment] in [Input Settings].
- Check that the device is correctly connected to the corresponding HDMI input jack.
- The HDMI settings of some playback devices need to be configured. Refer to the operating instructions supplied with each device.
- Be sure to use a Premium High Speed HDMI Cable with Ethernet, which supports bandwidths up to 18 Gbps. For video signals that require a high bandwidth such as 8K, 4K/120p, etc., be sure to use an Ultra High Speed HDMI Cable that supports bandwidths up to 48 Gbps. For details about the high bandwidth video format, see "[Video formats supported by the unit.](#)"
- Sound may not be output from the unit while the home menu is displayed on the TV screen. Press HOME to exit the home menu.
- Audio signals (format, sampling frequency, bit length, etc.) transmitted from an HDMI jack may be suppressed by the connected device. Check the setup of a device connected via an HDMI cable if the image is poor or the sound does not come out of the device.
- When a connected device does not support the copyright protection technology (HDCP), the image and/or the sound from the HDMI OUT A (TV) and HDMI OUT B/ZONE 2 jacks may be distorted or may not be output. If this is the case, check the specifications of the connected device.
- Set the image resolution of the playback device to more than 720p/1080i to enjoy DTS-HD Master Audio or Dolby TrueHD.
- The image resolution of the playback device may need to be configured to certain settings before you can enjoy DSD and Multi Channel Linear PCM. Refer to the operating instructions of the playback device.
- Make sure the TV supports the System Audio Control function.
- If the TV does not have a System Audio Control function, set [Audio Out] in the [HDMI Settings] menu to:
 - **[TV + AMP]**: if you want to listen to the sound from the TV speaker and unit.
 - **[AMP]**: if you want to listen to the sound from the unit only.
- When you connect the unit to a video device (projector, etc.), sound may not be output from the unit. In this case, set [Audio Out] to [AMP] in the [HDMI Settings] menu.
- You cannot listen to the sound of a device connected to the unit while TV input is selected on the unit.
 - Be sure to change the input of the unit to HDMI if you want to watch a program on a device connected via HDMI connection to the unit.
 - Change the TV channel if you want to watch a TV broadcast.
 - Be sure to select the correct device or input when watching a program from a device connected to the TV. Refer to the section on this operation in the operating instructions of the TV.
- Check that the selected digital audio input jack is not assigned to another input.

Related Topic

- [Notes on connecting cables](#)
- [Setting the HDMI audio signal output of connected devices \(Audio Out\)](#)

Multi Channel AV Receiver/Multi Channel AV Amplifier
STR-AN1000/TA-AN1000

The Dolby Atmos-compatible sound played back on the TV is not output from the unit.

- Connect the eARC/ARC-compatible HDMI input jack of your TV to the HDMI OUT A (TV) jack of the unit, then follow the steps in [“Setting TV audio output \(when using the eARC/ARC function\).”](#)

Multi Channel AV Receiver/Multi Channel AV Amplifier
STR-AN1000/TA-AN1000

The left and right sound is unbalanced or reversed.

- Check that the speakers and device are connected correctly and securely.
- Adjust the sound level parameters using the [Manual Speaker Settings] - [Level] in the [Speaker Settings] menu.

Multi Channel AV Receiver/Multi Channel AV Amplifier
STR-AN1000/TA-AN1000

Dolby Digital or DTS multi-channel sound is not reproduced.

- Check that the DVD, etc. you are playing is recorded in Dolby Digital or DTS format.
- When connecting the DVD player, etc., to the digital input jacks of this unit, make sure the digital audio output setting of the connected device is available.
- Set [Audio Out] to [AMP] in the [HDMI Settings] menu or change the speaker output setting to “Audio System” on the TV.
- You can only enjoy DTS-HD Master Audio, Dolby TrueHD and object-based audio formats (DTS:X and Dolby Atmos) with an HDMI connection.

Multi Channel AV Receiver/Multi Channel AV Amplifier
STR-AN1000/TA-AN1000

The surround effect cannot be obtained.

- Be sure to select the optimal sound field for the content. For details on the sound fields, see "[Selectable sound fields and their effects.](#)"
- To activate the virtualizer and obtain the surround effect when the speaker pattern is set to [2.0] or [2.1], set [Sound Field] to [A.F.D.], [A.F.D. Movie], [Dolby Mode] or [DTS:X Mode], set [Upmixer] to [Auto], and set [Virtualizer] to other than [Off].

Multi Channel AV Receiver/Multi Channel AV Amplifier
STR-AN1000/TA-AN1000

A test tone is not output from the speakers.

- The speaker cables may not be connected securely. Check that they are connected securely and cannot be disconnected by pulling on them slightly.
- The speaker cables may have short-circuited. Turn off the unit, reconnect them correctly, and then turn on the unit again.

Multi Channel AV Receiver/Multi Channel AV Amplifier
STR-AN1000/TA-AN1000

A test tone is output from a different speaker than the speaker displayed on the TV screen.

-
- The speaker pattern setting is incorrect. Make sure that the speaker connections and the speaker pattern match correctly.

Multi Channel AV Receiver/Multi Channel AV Amplifier
STR-AN1000/TA-AN1000

No sound is output to the TV from the connected HDMI device when the unit is in standby mode.

-
- When the unit enters standby mode, the image or sound from the last HDMI device selected before you turned off the unit is output. If no sound is output from the TV when the unit is in standby mode, perform the following operations.
 - Turn on the unit to select the HDMI device from which you want to play.
 - Make sure [Standby Through] is set to [Auto] or [On] in the [HDMI Settings] menu.
-

Related Topic

- [Enjoying content of a connected device without turning on the unit \(Standby Through\)](#)

TV sound cannot be heard from the speakers connected to the unit.

- Check the type and connection of the HDMI cable, optical digital cable, or audio cable that is connected to the unit and the TV (refer to the supplied Startup Guide).
- When the unit is connected to a TV compatible with the eARC or ARC function, make sure the unit is connected to an HDMI jack compatible with the eARC or ARC function (refer to the supplied Startup Guide). When connecting to a TV that is compatible with ARC (but not compatible with eARC), select [ARC] for [Audio Return Channel] in the [HDMI Settings] menu. If sound is still not output or if sound is interrupted, connect the optical digital cable (not supplied) and set [Audio Return Channel] to [Off].
- If the TV is not compatible with the eARC or ARC function, connect the unit to the TV using an optical digital cable (not supplied) or audio cable (not supplied). There will be no TV sound from the connected speakers when the unit is connected to an HDMI input jack of a TV that is not compatible with the eARC or ARC function.
- Switch input of the unit to [TV].
- Increase the volume on the unit or cancel muting.
- If the sound of a cable box or satellite box connected to the TV is not output, connect the device to an HDMI input jack of the unit and switch the input of the unit to the input for the connected device (refer to the supplied Startup Guide).
- Depending on the order in which the TV and the unit are turned on, the unit may be muted and [MUTING] is displayed on the display panel of the unit. If this happens, turn on the TV first, then the unit.
- Set the speaker setting of the TV (BRAVIA) to "Audio System." Refer to the operating instructions of your TV regarding how to set the TV.

Related Topic

- [TV sound cannot be heard from the speakers connected to the unit. \(eARC/ARC\)](#)

Multi Channel AV Receiver/Multi Channel AV Amplifier
STR-AN1000/TA-AN1000

Image and sound are not output from the TV when the unit is not turned on.

- Set [Control for HDMI] to [On], and then set [Standby Through] to [Auto] or [On] in the [HDMI Settings] menu.
- Turn on the unit, then select the input to which the playing device is connected.
- If connected to other devices than those manufactured by Sony that support the Control for HDMI function, set [Control for HDMI] to [On] in the [HDMI Settings] menu.
- Make sure the HDMI output setting is set to [HDMI A] or [HDMI A + B].

Multi Channel AV Receiver/Multi Channel AV Amplifier
STR-AN1000/TA-AN1000

The sound is output from both the unit and the TV.

- Mute the sound of the unit or the TV.
- If the HDMI audio signal from the connected playback device is output from both the speakers connected to the unit and the TV speakers, Set [Audio Out] to [AMP] in the [HDMI Settings] menu or change the speaker output setting to “Audio System” on the TV. The sound output will only come from the speakers connected to the unit.

Multi Channel AV Receiver/Multi Channel AV Amplifier
STR-AN1000/TA-AN1000

There is a time gap between the visual display on the TV and the audio output from the speaker connected to the unit.

-
- Change the [A/V Sync] settings in the [Audio Settings] menu.
 - Adjust the A/V Sync settings on the TV. For details, refer to the operating instructions of the TV.
 - When the sound field is set to [Audio Enhancer], change the sound field to other than [Audio Enhancer]. For details on the sound fields, see "[Selectable sound fields and their effects.](#)"

Multi Channel AV Receiver/Multi Channel AV Amplifier
STR-AN1000/TA-AN1000

The FM reception is poor (for US, Canadian, and Asia-Pacific models only).

- Extend and adjust the position of the FM wire antenna (aerial) to a place where the reception conditions are good.
 - Place the FM wire antenna (aerial) near a window.
 - Position the FM wire antenna (aerial) as horizontally as possible.
-

Related Topic

- [The FM stereo reception is poor \(for US, Canadian, and Asia-Pacific models only\).](#)
- [Connecting the antenna \(aerial\) \(for US, Canadian, and Asia-Pacific models only\)](#)

Multi Channel AV Receiver/Multi Channel AV Amplifier
STR-AN1000/TA-AN1000

The FM stereo reception is poor (for US, Canadian, and Asia-Pacific models only).

Perform the following procedure to set the FM station receiving mode to the monaural mode.

- 1 Select [Listen] - [FM TUNER] from the home menu.
- 2 Select a station on the FM band.
- 3 Press OPTIONS.
- 4 Select [FM Mode] from the menu.
- 5 Select [Monaural].

Note

- You can set FM mode in the options menu if the frequency indication is selected in step 3.

Related Topic

- [The FM reception is poor \(for US, Canadian, and Asia-Pacific models only\).](#)

Multi Channel AV Receiver/Multi Channel AV Amplifier
STR-AN1000/TA-AN1000

You cannot tune to radio stations (for US, Canadian, and Asia-Pacific models only).

- Check that the antennas (aerials) are connected securely. Adjust the antennas (aerials) if necessary.
- The signal of the stations is too weak with automatic tuning. Use direct tuning.
- No stations have been preset or the preset stations have been cleared (when tuning by scanning preset stations is used).
Preset the stations.
- Press DISPLAY MODE on the front of the unit repeatedly so that the frequency appears on the display panel.

Multi Channel AV Receiver/Multi Channel AV Amplifier
STR-AN1000/TA-AN1000

RDS does not work (for Asia-Pacific models only).

- Make sure that you are tuned to an FM RDS station.
- Select a stronger FM station.
- The station you tuned to is not transmitting the RDS signal or the signal is weak.

Multi Channel AV Receiver/Multi Channel AV Amplifier
STR-AN1000/TA-AN1000

The RDS information that you want does not appear (for Asia-Pacific models only).

- The service may be temporarily out of order. Contact the radio station and find out whether they actually provide the service in question.

Multi Channel AV Receiver/Multi Channel AV Amplifier
STR-AN1000/TA-AN1000

Are you using a compatible USB device?

- If you connect an incompatible USB device, the following problems may occur.
 - The USB device is not recognized.
 - File or folder names are not displayed on this unit.
 - Playback is not possible.
 - The sound skips.
 - There is noise.
 - Distorted sound is output.
-

Related Topic

- [USB specifications and compatible USB devices](#)

Multi Channel AV Receiver/Multi Channel AV Amplifier
STR-AN1000/TA-AN1000

When the music on the USB device is played back, there is noise, skipping, or distorted sound.

-
- Turn off the unit, reconnect the USB device, and then turn on the unit.
 - Check if the music data itself contains noise, or the sound is distorted.

Multi Channel AV Receiver/Multi Channel AV Amplifier
STR-AN1000/TA-AN1000

A USB device is not recognized.

- Turn off the unit, then disconnect the USB device. Turn on the unit again and reconnect the USB device.
- Connect a compatible USB device.
- The USB device does not work properly. Refer to the section on how to deal with this problem in the operating instructions of the USB device.

Multi Channel AV Receiver/Multi Channel AV Amplifier
STR-AN1000/TA-AN1000

Playback does not start.

- Turn off the unit, reconnect the USB device, and then turn on the unit.
 - Connect a compatible USB device.
 - Select [USB] on the [Listen] screen and select a folder/track, then press ►|| (play/pause) to start playback.
 - The unit can recognize and play up to the following files or folders in USB devices:
 - up to folders in the 11th layer (including the root folder)
 - up to 998 files/folders in a single layer
-

Related Topic

- [USB specifications and compatible USB devices](#)

Multi Channel AV Receiver/Multi Channel AV Amplifier
STR-AN1000/TA-AN1000

A USB device cannot be connected to the USB port.

- The USB device is being connected upside down. Connect the USB device in the correct orientation.
- Check the shape of the USB device's plug. If the shape does not fit the unit's port, you will not be able to connect the USB device to the unit.

Multi Channel AV Receiver/Multi Channel AV Amplifier
STR-AN1000/TA-AN1000

Erroneous display.

- The data stored in the USB device may have been corrupted.
- The character codes that can be displayed by this unit are as follows:
 - Upper case letters (A to Z)
 - Lower case letters (a to z)
 - Numbers (0 to 9)
 - Symbols (' = < > * + , - . / @ [\] _ `)

Other characters may not be displayed correctly.

Multi Channel AV Receiver/Multi Channel AV Amplifier
STR-AN1000/TA-AN1000

An audio file cannot be played.

- MP3 files in MP3 PRO format cannot be played.
- If you use a partitioned USB device, only audio files on the first partition can be played.
- Playback is possible up to 11 layers (including the root folder).
- There are more than 998 folders (including the root folder).
- There are more than 998 files.
- Files that are encrypted, protected by passwords, etc. cannot be played.

Multi Channel AV Receiver/Multi Channel AV Amplifier
STR-AN1000/TA-AN1000

Cannot connect to the network.

- Check that the LAN cable is connected to the unit when you want to connect the unit to the network via a wired LAN connection.
 - Check the network information. If the connection failed, set up the network connection again.
 - If the unit is connected through a wireless network, move the unit and the wireless LAN router/access point closer to each other and perform the setup again.
 - Make sure that you use a wireless LAN router/access point.
 - Make sure that the wireless LAN router/access point is turned on.
 - Check the settings of the wireless LAN router/access point and perform the setup again. For details on the settings of devices, refer to the operating instructions of the devices.
 - Wireless networks are influenced by electromagnetic radiation emitted by microwave ovens and other devices. Move the unit away from these devices.
-

Related Topic

- [Checking the network connection status \(Network Connection Status\)](#)

Multi Channel AV Receiver/Multi Channel AV Amplifier
STR-AN1000/TA-AN1000

Cannot connect to the network.



- Make sure the router or the wireless LAN router/access point is turned on.
 - The network settings on the unit may be incorrect. If the connection failed, set up the network connection again.
 - Confirm that the unit is connected to the router or the wireless LAN router/access point correctly.
 - If the unit is connected to a wireless network, move the unit and the wireless LAN router/access point closer to each other.
 - If you have initialized the unit or performed a system recovery on your server, perform the network settings again.
-

Related Topic

- [Setting up a wireless LAN connection](#)
- [Setting up a wired LAN connection](#)
- [Checking the network connection status \(Network Connection Status\)](#)

Multi Channel AV Receiver/Multi Channel AV Amplifier
STR-AN1000/TA-AN1000

Playback does not start, or the player does not automatically proceed to the next track or file.

-
- Make sure that the audio file you are trying to play is in a format supported by this unit.
 - Audio content with DRM (Digital Rights Management) copyright protection cannot be played on this unit.
 - Make sure that the repeat setting and shuffle setting are configured correctly. To set the playback mode, press ◀ (left) or ▶ (right), and then select  (repeat) or  (shuffle) on the screen, then press ⊕ (enter).
 - The unit can recognize and play up to the following files or folders stored in the home network server:
 - up to folders in the 19th layer
 - up to 999 files/folders in a single layer

Multi Channel AV Receiver/Multi Channel AV Amplifier
STR-AN1000/TA-AN1000

The sound skips during playback.

- If using wireless LAN connection, move the unit and the wireless LAN router/access point closer to each other, without any obstructions between them.
- The server may be busy. If using your computer as a server, the computer may be running too many applications. If anti-virus software is active on the computer, temporarily disable it as anti-virus software needs a large amount of system resources.
- Depending on the network environment, it may not be possible to play tracks on the multiple devices at the same time. Turn off other devices to enable the unit to play tracks.

Multi Channel AV Receiver/Multi Channel AV Amplifier
STR-AN1000/TA-AN1000

[There is no playable file.] appears.

- If there are no folders or files that can be played on the unit in the selected folder, you cannot expand the folder to display its content.

Multi Channel AV Receiver/Multi Channel AV Amplifier
STR-AN1000/TA-AN1000

Cannot play copyrighted files.

- Audio content with DRM (Digital Rights Management) copyright protection cannot be played on this unit.

5-037-030-11(5) Copyright 2022 Sony Corporation

Multi Channel AV Receiver/Multi Channel AV Amplifier
STR-AN1000/TA-AN1000

Cannot select a previously selected track.

- The track information may have been changed on the server. Refresh the server list and then reselect the server.

Multi Channel AV Receiver/Multi Channel AV Amplifier
STR-AN1000/TA-AN1000

Controller devices or applications on the home network cannot connect to the unit.

- Confirm that the network is correctly set up.
- Server operation of the unit is suspended if the unit is conducting one of the following operations:
 - Playing content stored on the server (the unit is operating as a player)
 - Updating the software
 - Displaying setting screen
- When using Sony | Music Center, also see “[Cannot control the unit using a Sony | Music Center device..](#)”

Multi Channel AV Receiver/Multi Channel AV Amplifier
STR-AN1000/TA-AN1000

The unit cannot be turned on by devices on a network.

- Set [Network/Bluetooth Standby] to [On] if you want to turn the unit on by operating the devices on a network.

Multi Channel AV Receiver/Multi Channel AV Amplifier
STR-AN1000/TA-AN1000

The unit cannot be found from an iPhone/iPad/iPod touch or iTunes.

- Make sure the unit and the iPhone/iPad/iPod touch or computer with iTunes is connected to the same network.
- Update the software of the unit and the iPhone/iPad/iPod touch or iTunes to the latest version.

Multi Channel AV Receiver/Multi Channel AV Amplifier
STR-AN1000/TA-AN1000

The sound skips during AirPlay playback.

- The sound may skip depending on factors such as the network environment. Depending on the audio files, playback may require network speed. If you use a wired LAN connection, check the network hub and/or router. If you use a wireless LAN connection, check the router and/or access point.

Multi Channel AV Receiver/Multi Channel AV Amplifier
STR-AN1000/TA-AN1000

AirPlay cannot be used.

- Update the software of the iPhone/iPad/iPod touch or iTunes to the latest version.
- Update the software of the unit to the latest version.
- Connection between the AirPlay device and unit may be lost. Restart the AirPlay device and/or the unit.
- The network connection between the iPhone/iPad/iPod touch or computer running iTunes, and the unit may be unstable.
 - Check the status and settings of the router for the network.
 - Try restarting the router, the iPhone/iPad/iPod touch or computer running iTunes, and the unit.
 - If using a wired LAN connection, make sure that the LAN cable is connected to the unit securely and is not broken.
 - If using a wireless LAN connection, make sure that both of the wireless LAN antennas on the unit are pointing up.
Additionally, try changing the positioning of the router and the unit. Keep the unit away from microwave ovens.

Multi Channel AV Receiver/Multi Channel AV Amplifier
STR-AN1000/TA-AN1000

Cannot connect the unit to a service.

- Make sure that the router or the wireless LAN router/access point is turned on.
 - Check [Network Connection Status]. If [Failed] appears, set up the network connection again.
 - If the unit is connected to a wireless network, move the unit and the wireless LAN router/access point closer to each other.
 - If your contract with your Internet provider limits Internet connection to one device at a time, this unit will not be able to access the Internet when another device is already connected. Consult your carrier or service provider.
-

Related Topic

- [Checking the network connection status \(Network Connection Status\)](#)

Multi Channel AV Receiver/Multi Channel AV Amplifier
STR-AN1000/TA-AN1000

The sound skips.

- The bandwidth of your network may be too low. If using wireless LAN connection, move the unit and the wireless LAN router/access point closer to each other, without any obstructions between them.

Multi Channel AV Receiver/Multi Channel AV Amplifier
STR-AN1000/TA-AN1000

Pairing cannot be done.

- Move the BLUETOOTH device closer to the unit.
- Pairing may not be possible if there are other BLUETOOTH devices near the unit. In this case, turn off the other BLUETOOTH devices.
- Enter "0000" when you are prompted for a passkey during the pairing operation.

Multi Channel AV Receiver/Multi Channel AV Amplifier
STR-AN1000/TA-AN1000

Cannot make a BLUETOOTH connection.

- Confirm that the BLUETOOTH mode is selected correctly.
 - When the BLUETOOTH device you attempted to connect does not support the A2DP profile, the device cannot be connected to the unit.
 - Press BLUETOOTH on the unit to connect to the last connected BLUETOOTH device.
 - Turn on the BLUETOOTH function of the BLUETOOTH device.
 - Establish a connection from the BLUETOOTH device.
 - The pairing registration information has been erased. Perform the pairing operation again.
 - While connected to a BLUETOOTH device, this unit cannot be detected from the other BLUETOOTH devices.
 - Erase the pairing registration information of the BLUETOOTH device and perform the pairing operation again.
-

Related Topic

- [Selecting the BLUETOOTH mode \(Bluetooth Mode\)](#)

Multi Channel AV Receiver/Multi Channel AV Amplifier
STR-AN1000/TA-AN1000

The sound skips or fluctuates, or the connection is lost.

- Move the BLUETOOTH device closer to the unit.
- If there are obstructions between the unit and your BLUETOOTH device, remove these or move the unit and/or device avoid them.
- If there is a device that generates electromagnetic radiation, such as a wireless LAN, other BLUETOOTH device, or a microwave oven nearby, move it away.

Multi Channel AV Receiver/Multi Channel AV Amplifier
STR-AN1000/TA-AN1000

The sound of your BLUETOOTH device cannot be heard on the unit.

- Turn up the volume on your BLUETOOTH device first, and then adjust the volume using  (volume) + on the remote control (or MASTER VOLUME on the unit).

Multi Channel AV Receiver/Multi Channel AV Amplifier
STR-AN1000/TA-AN1000

Severe humming or noise.

- If there are obstructions between the unit and your BLUETOOTH device, remove them or move the unit and/or device avoid them.
- If there is a device that generates electromagnetic radiation, such as a wireless LAN, other BLUETOOTH device, or a microwave oven nearby, move it away.
- Turn down the volume of the connected BLUETOOTH device.

Multi Channel AV Receiver/Multi Channel AV Amplifier
STR-AN1000/TA-AN1000

Cannot control the unit using a Sony | Music Center device.

- It may take some time for the unit to connect to the network after it is turned on. Try again later.
- The smartphone or tablet device may not be connected to the same network as the unit. Connect to the same network and try again.
- Also see "[Controller devices or applications on the home network cannot connect to the unit.](#)"
- Refer to the Sony | Music Center help.

Multi Channel AV Receiver/Multi Channel AV Amplifier
STR-AN1000/TA-AN1000

The Control for HDMI function does not work properly.

- Check the HDMI connection between the connected devices and the unit (refer to the supplied Startup Guide).
- Enable the Control for HDMI function on the TV. For details, refer to the operating instructions of the TV.
- Wait for a while, and then try again. If you unplug the unit, it will take a while before the operation is completed. Wait for 60 seconds or longer, and then try again.
- If you unplug the HDMI cable or change the connection of a device, enable the Control for HDMI function on the device.
- Make sure your TV is connected to the HDMI OUT A (TV) jack of the unit.
- Make sure the HDMI output setting is set to [HDMI A] or [HDMI A + B].
- Set [Control for HDMI] to [On] in the [HDMI Settings] menu.
- Make sure the connected device supports the Control for HDMI function.
- Enable the Control for HDMI function on the connected device. For details, refer to the operating instructions of the connected device.
- The types and number of devices that can be controlled by the Control for HDMI function are restricted by the HDMI CEC standard as follows:
 - Recording devices (Blu-ray Disc recorders, DVD recorders, etc.): up to 3 devices
 - Playback devices (Blu-ray Disc players, DVD players, game consoles, video and audio streaming devices, etc.): up to 3 devices
 - Tuner-related devices: up to 4 devices (used one by this unit)
 - Audio system (receiver, amplifier, headphones, etc.): up to 1 device (used by this unit)
- When [HDMI OUT B Mode] is set to [Zone2], the Control for HDMI function does not work.

Multi Channel AV Receiver/Multi Channel AV Amplifier
STR-AN1000/TA-AN1000

TV sound cannot be heard from the speakers connected to the unit. (eARC/ARC)

- Make sure [Audio Return Channel] is set to either [eARC] or [ARC] in the [HDMI Settings] menu.
 - Make sure [Input Mode] for the TV input is set to [Auto] in the [Input Settings] menu.
 - Make sure your TV supports the eARC or ARC function. Make sure that the HDMI input of your TV is labeled “eARC” or “ARC.”
 - If your TV has multiple HDMI input jacks, make sure the unit is connected to the one that supports the eARC or ARC function.
 - Make sure your TV is connected to the HDMI OUT A (TV) jack of the unit.
 - If your TV has a similar menu for eARC or ARC, or Control for HDMI function, also check the relevant settings on the TV. For details, refer to the operating instructions of the TV.
 - If you connect the unit to a TV that is compatible with the ARC function but not compatible with the eARC function, set [Audio Return Channel] to [ARC] in the [HDMI Settings] menu.
 - If you connect the unit to a TV that is incompatible with both the eARC and ARC functions, set [Audio Return Channel] to [Off] in the [HDMI Settings] menu, and connect the TV to the OPTICAL IN TV jack of the unit with an optical cable.
 - Make sure the HDMI output setting is set to [HDMI A] or [HDMI A + B].
 - Switch input of the unit to [TV].
-

Related Topic

- [Controlling HDMI devices \(Control for HDMI\)](#)
- [Switching between digital and analog audio \(Input Mode\)](#)
- [TV sound cannot be heard from the speakers connected to the unit.](#)

Multi Channel AV Receiver/Multi Channel AV Amplifier
STR-AN1000/TA-AN1000

The remote control does not function.

- Point the remote control at the remote control sensor on the unit.
- Remove any obstructions between the remote control and the unit.
- Replace both of the batteries in the remote control with new ones if they are weak.

Multi Channel AV Receiver/Multi Channel AV Amplifier
STR-AN1000/TA-AN1000

Reverting to the factory default settings

If the unit still does not operate properly, reset the unit.

- 1 Select [Setup] - [Resetting] from the home menu.
- 2 Select [All Settings].
- 3 Select [Start].

To cancel resetting

Select [Cancel] in step 3.

If you cannot perform resetting using the home menu

With the unit turned off, press and hold  (power) on the unit for more than 10 seconds. The settings return to their initial status.

Note

- It takes a few minutes for the memory to be cleared completely. Do not turn the unit off until [RESET] appears on the display panel.
- By resetting, the link with the wireless subwoofer and rear speakers (not supplied) may be lost. In this case, reconnect them by referring to their operating instructions.

Multi Channel AV Receiver/Multi Channel AV Amplifier
STR-AN1000/TA-AN1000

Resetting sound fields to the default settings

Be sure to use the buttons on the unit to perform this operation.

- 1 **Hold down MUSIC and press  (power) on the unit.**

[S.F.INITIALIZED!] appears on the display panel and all sound fields are reset to their default setting.

Multi Channel AV Receiver/Multi Channel AV Amplifier
STR-AN1000/TA-AN1000

Customer support websites

Refer to the following websites for the latest information on the unit.

For customers in Americas:

<https://www.sony.com/am/support>

For customers in Europe:

<https://www.sony.eu/support>

For customers in Asia-Pacific countries and regions:

<https://www.sony-asia.com/support>

Trademarks and Licenses

Trademarks

- Microsoft, Windows and Windows Media are either trademarks or registered trademarks of Microsoft Corporation in the United States and/or other countries.
- The LDAC™ name is a trademark of Sony Group Corporation or its affiliates.
- The BLUETOOTH® word mark and logos are registered trademarks owned by Bluetooth SIG, Inc. and any use of such marks by Sony Group Corporation and its subsidiaries is under license.
- The terms HDMI™, HDMI High-Definition Multimedia Interface, and the HDMI Logo are trademarks or registered trademarks of HDMI Licensing Administrator, Inc.
- Google, Google Play, Google Home and Chromecast built-in are trademarks of Google LLC. Google Assistant is not available in certain languages and countries.
- Apple, AirPlay, iPad, iPhone, iPod touch and Siri are trademarks of Apple Inc., registered in the U.S. and other countries.
- “BRAVIA” logo is a trademark of Sony Group Corporation or its affiliates.
- Wi-Fi®, Wi-Fi Protected Access® and Wi-Fi Alliance® are registered trademarks of Wi-Fi Alliance.
- Wi-Fi CERTIFIED™, WPA™, and WPA2™ are trademarks of Wi-Fi Alliance.
- Being Room Tested means that Sony and Roon have collaborated to ensure you have the best experience using Roon software and Sony equipment together, so you can just enjoy the music.
- “TRILUMINOS” and “TRILUMINOS” logo are a registered trademark of Sony Group Corporation or its affiliates.
- Spotify and Spotify logos are trademarks of the Spotify Group.*

* Depending on the country and region, this function may not be available.

All other trademarks and registered trademarks are trademarks or registered trademarks of their respective holders. In this manual, TM and ® marks are not specified.

Licenses

- Dolby, Dolby Vision, Dolby Atmos, Dolby Audio, and the double-D symbol are trademarks of Dolby Laboratories Licensing Corporation. Manufactured under license from Dolby Laboratories. Confidential unpublished works. Copyright © 1992–2021 Dolby Laboratories. All rights reserved.
- Manufactured under license from IMAX Corporation. IMAX® is a registered trademark of IMAX Corporation in the United States and/or other countries. For DTS patents, see <http://patents.dts.com>. Manufactured under license from DTS, Inc. DTS, DTS:X, Virtual:X, and the DTS:X logo are registered trademarks or trademarks of DTS, Inc. in the United States and other countries. © 2022 DTS, Inc. ALL RIGHTS RESERVED.
- Use of the Works with Apple badge means that an accessory has been designed to work specifically with the technology identified in the badge and has been certified by the developer to meet Apple performance standards.
- This product is protected by certain intellectual property rights of Microsoft Corporation. Use or distribution of such technology outside of this product is prohibited without a license from Microsoft or an authorized Microsoft subsidiary.
- For details of the GPL, LGPL and other software licenses, please refer to [Software License Information] in [System Settings] of the [Setup] menu on the product.
- The software included in this product contains copyrighted software that is licensed under the GPL/LGPL and other licenses which may require access to source code. You may find a copy of the relevant source code as required under the GPL/LGPL (and other licenses) at the following URL.
You may obtain the source code as required by the GPL/LGPL on a physical medium from us for a period of three years after our last shipment of this product by applying through the form at the following URL.
This offer is valid to anyone in receipt of this information.
<https://oss.sony.net/Products/Linux/>
Please note that Sony cannot answer or respond to any inquiries regarding the content of this source code.
- The Spotify Software is subject to third party licenses found here:
<https://www.spotify.com/connect/third-party-licenses>.
- **Disclaimer regarding services offered by third parties**

Network services, content and the (operating system and) software of this product may be subject to individual terms and conditions and changed, interrupted or discontinued at any time and may require fees, registration and credit card information.

5-037-030-11(5) Copyright 2022 Sony Corporation